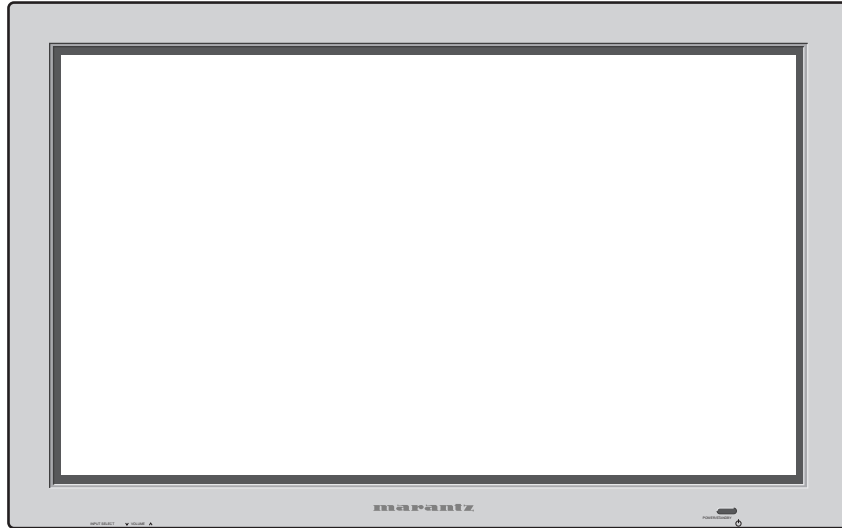


Service Manual

PD6120D /U1B

Plasma Monitor



REMARK : The PD6120D is a same product as the PX-61XM1A except the brand indications and accessories.
Please refer to the PX-61XM1A service manual (PART No. 007A) except following parts.

POS. NO.	VERS.	PART NO.	DESCRIPTION
Following spare parts are different from PX-61XM1A ones. (refer page 9-1)			
PK21		ZK334W0010	RC5010DPD (03S120012)
PK30		02AW851210	USER GUIDE for PD6120D (07S900024)
M21		02AW248010	FRONT PANEL ASSY (029DS0221)

Please use this service manual with referring to the user guide (D.F.U) without fail.

marantz®

PD6120D

MARANTZ DESIGN AND SERVICE

Using superior design and selected high grade components, **MARANTZ** company has created the ultimate in stereo sound. Only original **MARANTZ** parts can insure that your **MARANTZ** product will continue to perform to the specifications for which it is famous.

Parts for your **MARANTZ** equipment are generally available to our National Marantz Subsidiary or Agent.

ORDERING PARTS :

Parts can be ordered either by mail or by Fax.. In both cases, the correct part number has to be specified.

The following information must be supplied to eliminate delays in processing your order :

1. Complete address
2. Complete part numbers and quantities required
3. Description of parts
4. Model number for which part is required
5. Way of shipment
6. Signature : any order form or Fax. must be signed, otherwise such part order will be considered as null and void.

USA

MARANTZ AMERICA, INC.
1100 MAPLEWOOD DRIVE
ITASCA, IL. 60143
USA
PHONE : 630 - 741 - 0300
FAX : 630 - 741 - 0301

EUROPE / TRADING

MARANTZ EUROPE B.V.
P.O.BOX 80002, BUILDING SFF2
5600 JB EINDHOVEN
THE NETHERLANDS
PHONE : +31 - 40 - 2732241
FAX : +31 - 40 - 2735578

BRAZIL

PHILIPS DA AMAZONIA IND. ELET. ITDA
CENTRO DE INFORMACOES AO
CEP 04698-970
SAO PAULO, SP, BRAZIL
PHONE : 0800 - 123123(Discagem Direta Gratuita)
FAX : +55 11 534. 8988

PROFESSIONAL AMERICAS

SUPERSCOPE TECHNOLOGIES, INC.
MARANTZ PROFESSIONAL PRODUCTS
2640 WHITE OAK CIRCLE, SUITE A
AURORA, ILLINOIS 60504 USA
PHONE : 630 - 820 - 4800
FAX : 630 - 820 - 8103

PROFESSIONAL AUSTRALIA

TECHNICAL AUDIO GROUP PTY, LTD
558 DARLING STREET,
BALMAIN, NSW 2041,
AUSTRALIA
PHONE : 61 - 2 - 9810 - 5300
FAX : 61 - 2 - 9810 - 5355

CANADA

LENBROOK INDUSTRIES LIMITED
633 GRANITE COURT,
PICKERING, ONTARIO L1W 3K1
CANADA
PHONE : 905 - 831 - 6333
FAX : 905 - 831 - 6936

AUSTRALIA

QualiFI Pty Ltd,
24 LIONEL ROAD,
MT. WAVERLEY VIC 3149
AUSTRALIA
PHONE : +61 - (0)3 - 9543 - 1522
FAX : +61 - (0)3 - 9543 - 3677

THAILAND

MRZ STANDARD CO.,LTD
746 - 754 MAHACHAI ROAD.,
WANGBURAPAPIROM, PHRANAKORN,
BANGKOK, 10200 THAILAND
PHONE : +66 - 2 - 222 9181
FAX : +66 - 2 - 224 6795

SINGAPORE

WO KEE HONG DISTRIBUTION PTE LTD
130 JOO SENG ROAD
#03-02 OLIVINE BUILDING
SINGAPORE 368357
PHONE : +65 858 5535 / +65 381 8621
FAX : +65 858 6078

NEW ZEALAND

WILDASH AUDIO SYSTEMS NZ
14 MALVERN ROAD MT ALBERT
AUCKLAND NEW ZEALAND
PHONE : +64 - 9 - 8451958
FAX : +64 - 9 - 8463554

TAIWAN

PAI- YUING CO., LTD.
6 TH FL NO, 148 SUNG KIANG ROAD,
TAIPEI, 10429, TAIWAN R.O.C.
PHONE : +886 - 2 - 25221304
FAX : +886 - 2 - 25630415

MALAYSIA

WO KEE HONG ELECTRONICS SDN. BHD.
SUITE 8.1, LEVEL 8, MENARA GENESIS,
NO. 33, JALAN SULTAN ISMAIL,
50250 KUALA LUMPUR, MALAYSIA
PHONE : +60 3 - 2457677
FAX : +60 3 - 2458180

JAPAN *Technical*

MARANTZ JAPAN, INC.
35- 1, 7- CHOME, SAGAMIONO
SAGAMIHARA - SHI, KANAGAWA
JAPAN 228-8505
PHONE : +81 42 748 1013
FAX : +81 42 741 9190

日本マランツ株式会社

本社 〒228-8505
神奈川県相模原市相模大野7-35-1
営業本部 〒150-0022
東京都渋谷区恵比寿南1-11-9

KOREA

MK ENTERPRISES LTD.
ROOM 604/605, ELECTRO-OFFICETEL, 16-58,
3GA, HANGANG-RO, YONGSAN-KU, SEOUL
KOREA
PHONE : +822 - 3232 - 155
FAX : +822 - 3232 - 154

SHOCK, FIRE HAZARD SERVICE TEST :

CAUTION : After servicing this appliance and prior to returning to customer, measure the resistance between either primary AC cord connector pins (with unit NOT connected to AC mains and its Power switch ON), and the face or Front Panel of product and controls and chassis bottom.

Any resistance measurement less than 1 Megohms should cause unit to be repaired or corrected before AC power is applied, and verified before it is return to the user/customer.

Ref. UL Standard No. 1492.

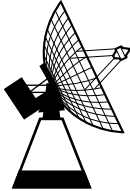
In case of difficulties, do not hesitate to contact the Technical Department at above mentioned address.

NEC

MODEL PX-61XM1A
PX-61XM1G
PX-61XM1U-S1

PlasmaSync™ Multimedia Monitor
SERVICE MANUAL

No. 007A



Better Service
Better Reputation
Better Profit

SAFETY CAUTION:

Before servicing this chassis, it is important that the service technician read and follow the "Safety Precautions" and "Product Safety Notice" in this Service Manual.

WARNING:

SHOCK HAZARD - Use an isolation transformer when servicing.

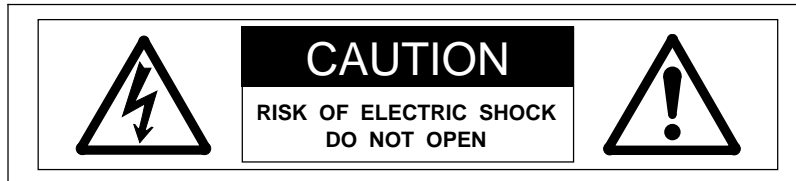
NEC Corporation

TOKYO, JAPAN

CONTENTS

SAFETY PRECAUTIONS	2-1
USER'S MANUAL	3-1
TROUBLESHOOTING	4-1
METHOD OF ADJUSTMENTS	5-1
CIRCUIT DESCRIPTION	6-1
METHOD OF DISASSEMBLY	7-1
PACKAGING	8-1
PARTS LIST	9-1
CONNECTION DIAGRAMS	10-1
BLOCK DIAGRAMS	11-1
SCHEMATIC DIAGRAMS	12-1

SAFETY PRECAUTIONS



CAUTION: TO REDUCE THE RISK OF ELECTRIC SHOCK, DO NOT OPEN REAR COVER. NO USER-SERVICEABLE PARTS INSIDE. REFER SERVICING TO QUALIFIED SERVICE PERSONNEL.



This symbol warns the user that un-insulated voltage within the unit may have sufficient magnitude to cause electric shock. Therefore, it is dangerous to make any kind of contact with any part inside of this unit.



This symbol alerts the user that important literature concerning the operation and maintenance of this unit has been included. Therefore, it should be read carefully in order to avoid any problems.



ATTENTION: POUR EVITER LES RISQUES D' ELECTROCUTION, NE PAS ENLEVER LE CONVERCLE ARRÈRE. AUCUN DES ELEMENTS INTERNES NE DOIT ETRE REPARÉ PAR L'UTILISATEUR. NE CONFIER L' ENTRETIEN QU'A UN PERSONNEL QUALIFIÉ.



L'éclair fléché dans un triangle équilatéral est destiné à avertir l'utilisateur de la présence, dans l'appareil, d'une zone non-isolée soumise à une haute tension dont l'intensité est suffisante pour constituer un risque d'électrocution.



Le point d'exclamation dans un triangle équilatéral est destiné à attirer l' attention de l'utilisateur sur la présence d'informations de fonctionnement et d'entretien importantes dans la brochure accompagnant l'appareil.



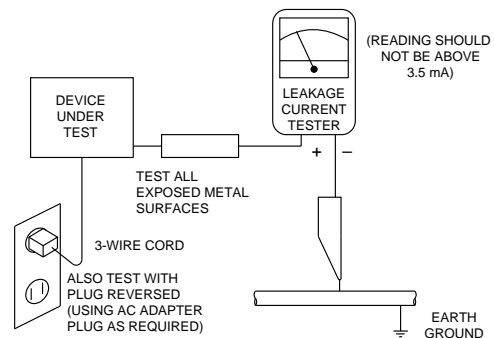
WARNING
HEATSINK MAY BE ENERGIZED.
TEST BEFORE TOUCHING.

SAFETY PRECAUTIONS

1. **Before returning an instrument to the customer**, always make a safety check of the entire instrument, including, but not limited to, the following items.

- a. Be sure that no built-in protective devices are defective and/or have been defeated during servicing. (1) Protective shields are provided on this chassis to protect both the technician and the customer. Correctly replace all missing protective shields, including any removed for servicing convenience. (2) When reinstalling the chassis and/or other assembly in the cabinet, be sure to put back in place all protective devices, including, but not limited to, nonmetallic control knobs, insulating fishpapers, adjustment and compartment covers/shields, and isolation resistor/capacitor networks. **Do not operate this instrument or permit it to be operated without all protective devices correctly installed and functioning.**
- b. Be sure that there are no cabinet openings through which an adult or child might be able to insert their fingers and contact a hazardous voltage. Such opening include, but are not limited to, (1) spacing between the picture tube and the cabinet mask, (2) excessively wide cabinet ventilation slots, and (3) an improperly fitted and/or incorrectly secured cabinet back cover.
- c. **Leakage Current Hot Check** — With the instrument completely reassembled, plug the AC line cord directly into a 240V AC outlet. (Do not use an isolation transformer during this test.) Use a leakage current tester or a metering system that complies with American National Standards Institutes (ANSI) C101.1 Leakage Current for Appliances and Underwriters Laboratories (UL) 1950. With the instrument AC switch first in the ON position and then in the OFF position, measure from a known earth ground (metal waterpipe, conduit, etc.) to all exposed metal parts of the instrument (antennas, handle bracket, metal cabinet, screwheads, metallic overlays, control shafts, etc.), especially any exposed metal parts that offer an electrical return path to the chassis. Any current measured must not exceed 3.5 milliamp. Reverse the instrument power cord plug in the outlet and repeat test. **ANY MEASUREMENTS NOT WITHIN THE LIMITS SPECIFIED HEREIN INDICATE A POTENTIAL SHOCK HAZARD THAT MUST BE ELIMINATED BEFORE RETURNING THE INSTRUMENT TO THE CUSTOMER.**

AC Leakage Test



2. Read and comply with all caution and safety-related notes on or inside the Monitor cabinet, on the Projection Monitor chassis, or on the picture tube.
3. **Design Alteration Warning** — Do not alter or add to the mechanical or electrical design of this unit. Design alterations and additions, including, but not limited to, circuit modifications and the addition of the items such as auxiliary audio and/or video output connections might alter the safety characteristics of this Monitor and create a hazard to the user. Any design alterations or additions will void the manufacturer's warranty and will make you, the servicer, responsible for personal injury or property damage resulting therefrom.
4. **Hot Chassis Warning** —
 - a. Some MultiSync Monitor chassis are electrically connected directly to one conductor of the AC power cord and may be safely serviced without an isolation transformer only if the AC power plug is inserted so that the chassis is connected to the ground side of the AC power source. To confirm that the AC power plug is inserted correctly, with an AC voltmeter measure between the chassis and a known earth ground. If a voltage reading in excess of 1.0V is obtained, remove and reinsert the AC power plug in the opposite polarity and again measure the voltage potential between the chassis and a known earth ground.
 - b. Some Plasma chassis normally have 85V AC (RMS), between chassis and earth ground regardless of the AC plug polarity. These chassis can be safely serviced only with an isolation transformer inserted in the power line between the receiver and the AC power source, for both personnel and test equipment protection.
 - c. Some Plasma chassis have a secondary ground systems in addition to the main chassis ground. This secondary ground system is not isolated from the AC power line. The two ground system are electrically separated by insulating material that must not be defeated or altered.

SAFETY PRECAUTIONS

5. Observe original lead dress. Take extra care to assure correct lead dress in the following areas:
 - a. near sharp edges,
 - b. near thermally hot parts—be sure that leads and components do not touch thermally hot parts,
 - c. the AC supply,
 - d. high voltage, and
 - e. antenna wiring.Always inspect in all areas for pinched, out-of-place, or frayed wiring. Do not change spacing between components, and between components and the printed-circuit board. Check AC power cord for damage.
6. Components, parts, and/or wiring that appear to have overheated or are otherwise damaged should be replaced with components, parts, or wiring that meet original specifications. Additionally, determine the cause of overheating and/or damage and, if necessary, take corrective action to remove any potential safety hazard.
7. **PRODUCT SAFETY NOTICE** —Many MultiSync Monitor electrical and mechanical parts have special safety-related characteristics some of which are often not evident from visual inspection, nor can the protection they give necessarily be obtained by replacing them with components rated for higher voltage, wattage, etc. Parts that have special safety characteristics are identified in this service data by shading with a ⚠ mark on schematics and by shading or a ⚠ mark in the parts list. Use of a substitute replacement part that does not have the same safety characteristics as the recommended replacement part in this service data parts list might create shock, fire, and/or other hazards.

PRECAUTIONS DE SECURITE

1. Avant de remettre un appareil à un client, faire toujours d'abord un examen de sécurité de l'appareil en entier comprenant, mais ne s'y limitant pas les points cités ci-dessous:

a. Vérifier qu' aucun des dispositifs de protection ne soit défectueux ou n' ait été endommagé pendant les travaux.

(1) Les volets protecteurs sur ce châssis ont été montés pour protéger aussi bien le technicien que le client. Remplacer correctement tous les volets protecteurs manquants, aussi bien que ceux qui ont pu être enlevés pour la commodité des travaux.

(2) Quand vous remettez le châssis ou d'autres assemblages ensemble dans le coffret, vérifier qu' ont été remis à leur place tous les dispositifs de protection, comprenant mais ne s' y limitant point, les boutons de contrôle non-métalliques, les feuilles d'isolation, les couverture/volets de l'ajustement et du compartiment, et l'isolation des réseaux résistance/condensateur. **Ne pas travailler sur cet appareil ni permettre qu'y soit effectué un travail sans que tous les dispositifs de protection n' y soient correctement installés fonctionnants.**

b. Bien vérifier qu'il n'y ait aucune ouverture sur le coffret qui ne puisse permettre à un adulte ou à un enfant d'y faire pénétrer ses doigts et attraper une décharge électrique.

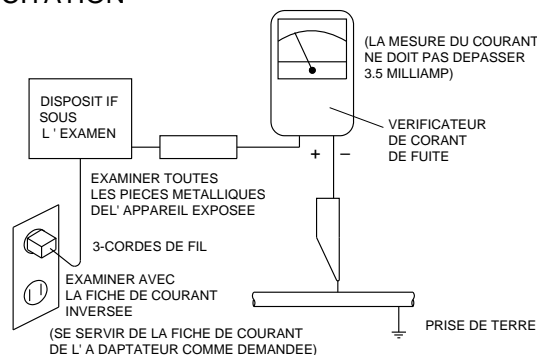
De telles ouvertures comprendraient sans pour autant s'y limiter (1) l'espace entre le tube à images et le coffret de l'appareil, (2) les espaces excessivement ouverts pour la ventilation et (3) la couverture arrière du coffret improprement fixée ou incorrectement protégée.

c. **Vérification de courant de fuite**

L'appareil ayant été complètement réassemblé, brancher-le à une prise de courant de 240V. (Ne pas se servir d'un transformateur d'isolation pendant ce test). Se servir d'un vérificateur de courant d'excitation ou d'un système de mesure conforme aux normes ANSI (American National Standards Institute) C101.1 Leakage Current for Appliances et U. L (Underwriters Laboratories) 1950. Le bouton de l'appareil en position "Marche" et ensuite en position "Arrêt", mesurer à partir d'une prise de terre (métallique tuyauterie, conduite, etc...) à toutes les pièces métalliques de l'appareil exposées (antennes, poignet métalliques, coffren métallique, tête des vis, surfaces métalliques, traits de contrôle, etc.) surtout à toutes les pièces métalliques exposées qui peuvent reconduire le courant au châssis. En aucun cas, la mesure du

courant ne doit dépasser 3.5 milliamp. Inverser la fiche de courant de l'appareil dans la prise et répéter le test. **Tout mesurage ne s'arrêtant pas aux limites spécifiées icicomporte un risque de décharge électrique dangereux, qui doit être éliminé, avant que l'appareil ne soit remis au client.**

EXAMEN DE COURANT D'EXCITATION



2. Lire et respecter toutes les mises en garde et notes de sécurité à l'intérieur ou à l'extérieur du coffret du rétro-projecteur, sur le châssis du rétro-projecteur ou sur le tube à images.



3. **Mise en garde contre la modification du dessin**

Ne pas modifier ni ajouter à la pièce mécanique ou électrique du modèle. Des modifications ou additions, comportant, mais ne s'y limitant pas, des modifications des circuits et l'addition d'éléments tels que des auxilliaires audio et/ou des branchements pour la prise de vidéo, pourrait éprouver la sécurité de ce rétro-projecteur et créer un risque pour l'utilisateur. Tout changement ou addition accomplie annulera la garantie du fabricant et va rendre votre service d'entretien, responsable des dommages corporels ou de biens en résultant.

4. **Mise en garde contre le châssis sous tension**

a. Certains châssis de rétro-projecteur sont électriquement reliés à un conducteur du fil de courant et ainsi peuvent ne comporter aucun risque sans un transformateur d'isolation seulement si la prise de courant est branchée, de manière que le châssis est relié à la prise de terre de la source de courant. Pour s'assurer que la prise de courant est correctement insérée, relever les mesures avec un voltmètre de courant entre le châssis et un point de prise de terre bien connu. Si le voltage indiqué est supérieur à 1,0V, débrancher et reinsérer la prise de courant dans la polarité contraire et une fois de plus remesurer le voltage potentiel entre le cassis et la prise de terre.

PRECAUTIONS DE SECURITE

- b. Certains châssis de moniteur ont habituellement 85V (RMS) entre le châssis et la prise de terre, en fonction de la polarité de la prise de courant. Ces châssis peuvent ne comporter aucun risque seulement avec un transformateur d'isolation inséré dans la ligne de puissance située entre de rétro-projecteur et la source d'électricité, cela pour la protection aussi bien du personnel que du matériel de vérification.
 - c. Certains châssis de rétro-projecteur ont un système secondaire de masse en addition avec le système principal de masse du châssis. Ce système secondaire de masse n'est pas isolé du courant électrique. Les deux systèmes sont électriquement séparés par du matériel d'isolation qu' on vérifiera bien qu'il ne soit ni altéré ni défectueux.
5. Vérifier la couverture originale en plomb. Accorder la plus grande attention à la couverture de plomb notamment aux endroits ci-dessous indiqués.
- a. Près des bords aigus
 - b. près des parties très chaudes
Vérifier que les composants et les plombs ne touchent pas les parties très chaudes telles que:
 - c. l'alimentation du courant
 - d. la haute tension
 - e. les fils de l'antenne
- Pousser l'inspection, à tous les endroits, à la recherche des cordes pincées, déplacées ou effilochées. Ne pas changer l'écartement entre composants, et entre composants et le tableau de circuit imprimé. Vérifier que le fil de conduite électrique est en bon état.
6. Les composants, parts (pièces) et/ou fils qui ont été trouvés surchauffés devraient être remplacés avec les composants, pièces et fils s'y reliant avec d'autre qui ont les mêmes spécifications que les originales. De plus, rechercher la cause du surchauffement et/ ou des dommages et si nécessaire, prendre les mesures propres pour prévenir tout risque potentiel.
- 7. Note sur sûreté de l'appareil**
- Beaucoup de pièce de rétro-projecteur, qu'elles soient électriques ou mécaniques, ont des dispositions de sécurité qui ne sont pas toujours évidentes d'une simple inspection visuelle et la protection qu'elles donnent nécessairement ne pourront être pas obtenues par les remplaçants avec des composants aux voltages ou watts plus élevés. Les pièces qui ont des caractéristiques particulières de sécurité sont identifiées avec un trait  marqué sur les schémas et sont ombragés ou comportent un trait  sur la liste des pièces. L'utilisation d'un produit substitutif qui n'aurait pas les mêmes caractéristiques comme il est recommandé dans ces données d'entretien pourrait provoquer une décharge électrique, un feu, et/ou d'autres dangers.

SAFETY PRECAUTIONS

1 . Cautions for disassembly

- (1) For the suspension-type set (No. of workers: 3 to 5 including assistants)
- Take adequate measures in order not to damage the surface of the set or the filter, using a protection mat (vinyl sheet or blanket).
 - When relieving the set from the condition of suspension from the ceiling, do not tilt its main body too much by supporting its both sides, while the mounting hooks (top and bottom) are released. (Reasons: If the main body is positioned slantwise, a load is applied to its upper part and there can be danger of making the set fall down carelessly when the set is unhooked.)
 - During disassembly, the allocation of personnel should be such that suitable stands or platforms are assuredly arranged to enable the personnel to support the set, standing on both sides of the set. For safety, it is preferable to provide for assistant personnel who can receive the removed set.
 - During this removal work, support the set at its frame with hands. Never touch the filter or glass surface. Assistant personnel on the front side should apply hands to the lower part of the casing. [If the casing is strongly hit with a wooden hammer or the like, the unseen side area of the module panel glass may be broken even though the module itself does not seem to have been broken . Therefore , support the frame by hand in order not to drop it.]
- (2) For the wall-hang type, corner type, or pole unit mounting set (No. of workers: 2 <generally>)
- Examining a good timing, release the mounting hooks (top and bottom) from the right and the left.
 - If the set is installed in an elevated place, provide for firm scaffolds in advance. It is preferable to ask for the support of assistant personnel as in the case of the suspension type.
 - During this removal work, try to support the set at its frame with hands. Never touch the filter or glass surface. Assistant personnel on the front side should apply hands to the lower part of the casing. [If the casing is strongly hit with a wooden hammer or the like, the unseen side area of the module panel glass may be broken even though the module itself does not seem to have been broken. Therefore, support the frame by hand in order not to drop it.]

2. The least minimum cautions for product disassembly

- Secure a working space, arranged as wide as possible.
- Prior to disassembling the set, protect the acrylic surface with an air mat or the like.
- To prevent the thread ridges from being damaged, use an adequate screwdriver.
- Many screws are actually used. Therefore, use two or three containers where these screws can be kept . Never disassemble the inner parts of the module (pipes, etc.).
- When lifting the module from the set, two persons should stand on both sides of the module to hold the stable parts of the junction while they lift the module upright. (If dust or such foreign substance enters in between the module and the filter, moir* or similar problems can arise. In addition, once it enters, it is necessary to take careful measures not to damage the contamination area while removing contaminants.) [Please understand that the replacement of the module may call for an air-blast treatment (air brush) in a clean room.]
Complementary caution) In particular, if a conductive foreign matter (such as a metallic chip) is attached to the flexible cable of the module, there can be danger of the occurrence of a phenomenon like wire breakage that is caused by partition breakdown in the module. For this reason, it is necessary to bear in mind that the flow of air blast should be directed only in the predetermined direction at all times.

3. Method of returning the set (when returning the set to the manufacturing base in Japan)

- When returning the set, put the set in the specified package box.
Otherwise, swinging and vibration loads may be applied to the set during transportation, and this may give rise to destruction of a mounting section, such as gas-hermetically-sealed pipe (glass) of the module.
- When optional parts are also put in the box for returning, a list of options (accessories) should also be produced and returned, if possible. This arrangement is effective to confirm the owner of the returned items.
- To confirm the user-oriented problem, and for the purpose of future improvements, a report of reasons for malfunction should also be packed.
A definite address should be specified so that the repaired set can be returned and faulty phenomena can be confirmed .

SAFETY PRECAUTIONS

(Notes)

The component by the name of “module” used in this product is defined as a section that is provided with a digital circuit board (including high-voltage parts) used to emit light in the glass panel part, excluding the surface acrylic filter or the tempered glass filter. It must be noted that it does never mean the glass panel part only.

USER'S MANUAL

PlasmaSync Plasma Monitor

PlasmaSync[™] 61MP1

User's Manual



NEC


NEC Technologies

Important Information


Precautions

Please read this manual carefully before using your NEC plasma monitor and keep the manual handy for future reference.


CAUTION




**RISK OF ELECTRIC SHOCK
DO NOT OPEN**



CAUTION: TO REDUCE THE RISK OF ELECTRIC SHOCK, DO NOT REMOVE COVER. NO USER-SERVICEABLE PARTS INSIDE. REFER SERVICING TO QUALIFIED SERVICE PERSONNEL.



This symbol warns the user that uninsulated voltage within the unit may have sufficient magnitude to cause electric shock. Therefore, it is dangerous to make any kind of contact with any part inside of this unit.



This symbol alerts the user that important literature concerning the operation and maintenance of this unit has been included. Therefore, it should be read carefully in order to avoid any problems.

WARNING

TO PREVENT FIRE OR SHOCK HAZARDS, DO NOT EXPOSE THIS UNIT TO RAIN OR MOISTURE. ALSO DO NOT USE THIS UNIT'S POLARIZED PLUG WITH AN EXTENSION CORD RECEPTACLE OR OTHER OUTLETS, UNLESS THE PRONGS CAN BE FULLY INSERTED. REFRAIN FROM OPENING THE CABINET AS THERE ARE HIGH-VOLTAGE COMPONENTS INSIDE. REFER SERVICING TO QUALIFIED SERVICE PERSONNEL.

WARNING

This equipment has been tested and found to comply with the limits for a Class A digital device, pursuant to Part 15 of the FCC Rules. These limits are designed to provide reasonable protection against harmful interference when the equipment is operated in a commercial environment. This equipment generates, uses, and can radiate radio frequency energy and, if not installed and used in accordance with the instruction manual, may cause harmful interference to radio communications. Operation of this equipment in a residential area is likely to cause harmful interference in which case the user will be required to correct the interference at his own expense.

Warnings and Safety Precaution

The NEC plasma monitor is designed and manufactured to provide long, trouble-free service. No maintenance other than cleaning is required. Use a soft dry cloth to clean the panel. Never use solvents such as alcohol or thinner to clean the panel surface.

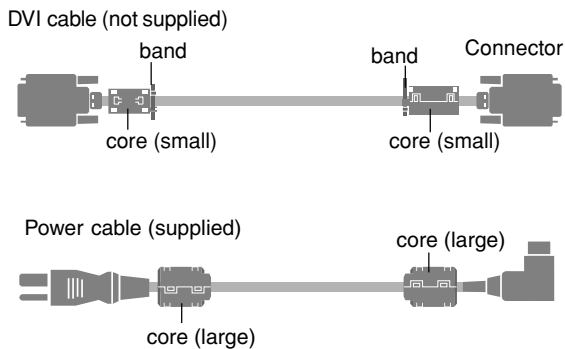
The plasma display panel consists of fine picture elements (cells). Although NEC produces the plasma display panels with more than 99.99 percent active cells, there may be some cells that do not produce light or remain lit.

For operating safety and to avoid damage to the unit, read carefully and observe the following instructions. To avoid shock and fire hazards:

1. Provide adequate space for ventilation to avoid internal heat build-up. Do not cover rear vents or install the unit in a closed cabinet or shelves.
The unit is equipped with cooling fans. If you install the unit in an enclosure, make sure there is adequate space at the top of the unit to allow hot air to rise and escape. If the monitor becomes too hot, the overheat protector will be activated and the monitor will be turned off. If this happens, turn off the power to the monitor and unplug the power cord. If the room where the monitor is installed is particularly hot, move the monitor to a cooler location, and wait for the monitor to cool for 60 minutes. If the problem persists, contact your NEC dealer for service.
2. Do not use the power cord polarized plug with extension cords or outlets unless the prongs can be completely inserted.
3. Do not expose the unit to water or moisture.
4. Avoid damage to the power cord, and do not attempt to modify the power cord.
5. Unplug the unit during electrical storms or if the unit will not be used over a long period.
6. Do not open the cabinet which has potentially dangerous high voltage components inside. If the unit is damaged in this way the warranty will be void. Moreover, there is a serious risk of electric shock.
7. Do not attempt to service or repair the unit. NEC is not liable for any bodily harm or damage caused if unqualified persons attempt service or open the back cover. Refer all service to authorized NEC Service Centers.

NOTE:

When you connect a computer to this monitor, attach the supplied ferrite cores. If you do not do this, this monitor will not conform to mandatory FCC standards. Attaching the ferrite cores:
Set the ferrite cores on both ends of the DVI cable (not supplied), and both ends of the power cable (supplied). Close the lid tightly until the clamps click. Use the band to fasten the ferrite core (supplied) to the DVI cable.



To avoid damage and prolong operating life:

1. Use only with 120V 50/60Hz AC power supply. Continued operation at line voltages greater than 120 Volts AC will shorten the life of the unit, and might even cause a fire hazard.
2. Handle the unit carefully when installing it and do not drop.
3. Set the unit away from heat, excessive dust, and direct sunlight.
4. Protect the inside of the unit from liquids and small metal objects. In case of accident, unplug the unit and have it serviced by an authorized NEC Service Center.
5. Do not hit or scratch the panel surface as this causes flaws on the surface of the screen.
6. For correct installation and mounting it is strongly recommended to use a trained, authorized NEC dealer.
7. As is the case with any phosphor-based display (like a CRT monitor, for example) light output will gradually decrease over the life of a Plasma Display Panel.

Recommendations to avoid or minimize phosphor burn-in

Like all phosphor-based display devices and all other gas plasma displays, plasma monitors can be susceptible to phosphor burn under certain circumstances. Certain operating conditions, such as the continuous display of a static image over a prolonged period of time, can result in phosphor burn if proper precautions are not taken. To protect your investment in this NEC plasma monitor, please adhere to the following guidelines and recommendations for minimizing the occurrence of image burn:

- * Always enable and use your computer's screen saver function during use with a computer input source.
- * Display a moving image whenever possible.
- * Change the position of the menu display from time to time.
- * Always power down the monitor when you are finished using it.

If the plasma monitor is in long term use or continuous operation take the following measures to reduce the likelihood of phosphor burn:

- * Lower the Brightness and Contrast levels as much as possible without impairing image readability.
- * Display an image with many colors and color gradations (i.e. photographic or photo-realistic images).
- * Create image content with minimal contrast between light and dark areas, for example white characters on black backgrounds. Use complementary or pastel color whenever possible.
- * Avoid displaying images with few colors and distinct, sharply defined borders between colors.

Contact NEC Technologies at 1-800-836-0655 for other recommended procedures that will best suit your particular application needs.

Précautions

Veillez lire ce manuel avec attention avant d'utiliser votre moniteur PlasmaSync NEC et conserver ce manuel à portée de la main pour une consultation ultérieure.

ATTENTION



**RISQUE D'ELECTROCUTION
NE PAS OUVRIR**



MISE EN GARDE: AFIN DE REDUIRE LES RISQUES D'ELECTROCUTION, NE PAS DEPOSER LE COUVERCLE, IL N'Y A AUCUNE PIECE UTILISABLE A L'INTERIEUR DE CET APPAREIL. NE CONFIER LES TRAVAUX D'ENTRETIEN QU'A UN PERSONNEL QUALIFIE.

Ce symbole a pour but de prévenir l'utilisateur de la présence d'une tension dangereuse, non isolée se trouvant à l'intérieur de l'appareil. Elle est d'une intensité suffisante pour constituer un risque d'électrocution. Eviter le contact avec les pièces à l'intérieur de cet appareil.

Ce symbole a pour but de prévenir l'utilisateur de la présence d'importantes instructions concernant l'entretien et le fonctionnement de cet appareil. Par conséquent, elles doivent être lues attentivement afin d'éviter des problèmes.

AVERTISSEMENT

AFIN DE REDUIRE LES RISQUES D'INCENDIE OU D'ELECTROCUTION, NE PAS EXPOSER CET APPAREIL A LA PLUIE OU A L'HUMIDITE. AUSSI, NE PAS UTILISER LA FICHE POLARISEE AVEC UN PROLONGATEUR OU UNE AUTRE PRISE DE COURANT SAUF SI CES LAMES PEUVENT ETRE INSEREES A FOND. NE PAS OUVRIR LE COFFRET, DES COMPOSANTS HAUTE TENSION SE TROUVENT A L'INTERIEUR. LAISSER A UN PERSONNEL QUALIFIE LE SOIN DE REPARER CET APPAREIL.

DOC avis de conformation

Cet appareil numérique de la classe A respecte toutes les exigences du Règlement sur le Matériel Brouilleur du Canada.

Mises en garde et précautions de sécurité

Le moniteur PlasmaSync NEC a été conçu et fabriqué pour une utilisation fiable et durable. Il ne nécessite aucun entretien en dehors du nettoyage. Utiliser un chiffon doux et sec pour nettoyer la surface de l'écran. Ne jamais utiliser de solvant comme l'alcool ou le diluant. Le panneau à affichage plasma est constitué de fines particules d'images ou pixels (cellules). Bien que NEC produise des panneaux à affichage plasma avec plus de 99,99 % de cellules actives, il peut y avoir des cellules qui ne produisent pas de lumière ou qui restent allumées.

Pour des raisons de sécurité et pour éviter d'endommager l'appareil, lire attentivement les instructions suivantes.

Pour éviter les risques d'électrocution et d'incendie:

1. Laisser suffisamment d'espace autour de l'appareil pour la ventilation et éviter toute augmentation excessive de la température interne. Ne pas couvrir les événements ou l'installer dans un endroit trop exigü. L'appareil est équipé de ventilateurs de refroidissement. Si vous installez l'appareil dans un espace clos, assurez-vous qu'il y ait suffisamment d'espace au dessus pour permettre à l'air chaud de s'élever et de s'évacuer. Si la température du moniteur devient excessive, la protection contre les surchauffes entrera en action et coupera l'alimentation. Dans ce cas, éteindre l'appareil et débrancher le câble d'alimentation. Si la température de la pièce dans laquelle le moniteur est installé est particulièrement excessive, déplacer l'appareil dans un endroit plus frais et le laisser refroidir 60 minutes. Si le problème persiste, prendre contact avec le revendeur NEC pour le service après-vente.
2. Ne pas utiliser la fiche polarisée du cordon d'alimentation avec des prolongateurs ou des prises de courant, sauf si les lames peuvent être insérées à fond.
3. Ne pas exposer à l'eau ou à l'humidité.
4. Eviter d'endommager le cordon d'alimentation, et ne pas modifier le cordon d'alimentation.
5. Débrancher l'appareil pendant les tempêtes ou si l'appareil n'est pas utilisé pendant une longue période.
6. Ne pas ouvrir le coffret. Des composants de haute tension se trouvent à l'intérieur. Si l'appareil est endommagé de cette manière, la garantie devient caduque. De plus, il y a risque d'électrocution.
7. Ne pas essayer de réparer ou entretenir l'appareil soi-même. NEC ne saura être tenu pour responsable pour toute blessure ou dommage causé par des personnes non qualifiées qui essaient de réparer ou d'ouvrir le couvercle arrière. Confier toute réparation à un centre de service agréé NEC.

REMARQUE:

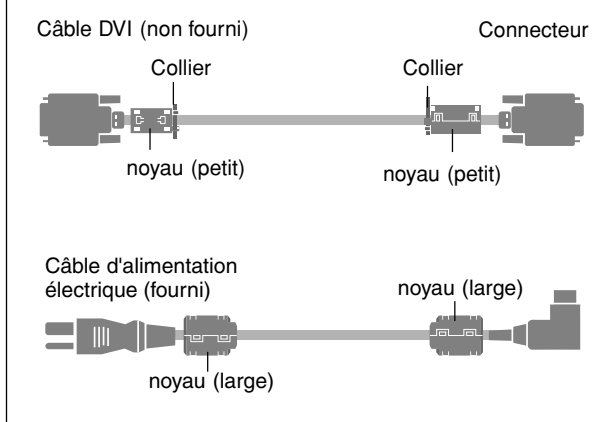
Lorsque vous branchez un micro-ordinateur sur ce moniteur, fixez les noyaux en ferrites fournis. Si vous ne le faites, le moniteur ne sera pas en conformité avec les exigences des standards FCC.

Fixation des noyaux en ferrite.

Monter les tores en ferrite aux deux extrémités du câble DVI (non fourni) et aux deux extrémités du câble d'alimentation électrique (fourni).

Fermez doucement le couvercle jusqu'à ce que les crans se clipent.

Fixer le tore en ferrite (fourni) au câble DVI à l'aide d'un collier.



Pour éviter le risque de combustion au phosphore, les mesures suivantes sont recommandées :

Comme tous les appareils d'affichage à base de phosphore et tous les autres affichages à gaz plasma, les moniteurs Plasmasync peuvent être sujets à la combustion au phosphore dans certaines circonstances. Certaines conditions d'utilisation, telles que l'affichage continu d'une image statique pour une durée prolongée, peuvent causer des brûlures au phosphore si aucune précaution n'est prise. Pour protéger votre investissement dans ce moniteur PlasmaSync NEC, veuillez suivre les directives et les recommandations suivantes pour minimiser l'occurrence de brûlure d'image :

- Assurez-vous de mettre en marche et d'utiliser l'économisateur d'écran chaque fois que c'est possible lorsque vous l'utilisez avec une source d'entrée d'ordinateur.
- Affichez une image en mouvement aussi souvent que possible.
- Changez la position de l'affichage de menu de temps à autre.
- Coupez toujours l'alimentation lorsque vous avez terminé d'utiliser la moniteur.

Si le moniteur est en usage continu ou longue durée, prenez les mesures suivantes afin d'éviter l'occurrence de combustion au phosphore :

- Abaissez le niveau de l'image (contraste, luminosité) autant que possible, sans faire perdre la lisibilité de l'image.
- Affichez une image avec de nombreuses couleurs et graduations de couleur (par ex. des images photographiques ou photo-réalistes).
- Créez un contenu d'image avec un contraste minimal entre les zones sombres et les zones claires, par exemple, des caractères blancs sur un fond noir. Utilisez des couleurs complémentaires ou pastels le plus souvent possible.
- Évitez d'afficher des images avec peu de couleurs et des limites nettes et clairement définies entre les couleurs.

Contactez NEC Technologies au 1-800-836-0655 pour d'autres procédures recommandées qui conviendront le mieux au besoin de votre appareil.

Pour éviter des dommages et prolonger la durée de service de l'appareil:

1. N'utiliser qu'une source d'alimentation de 120 V 50/60 Hz CA. Le fait d'utiliser l'appareil en continu à des tensions de ligne supérieures à 120 Volts CA réduit sa durée de vie et risque de provoquer un incendie.
2. Manipuler l'appareil avec soin pendant son déplacement et ne pas le faire tomber.
3. Eloigner l'appareil des endroits chauds, très poussiéreux et exposés en plein soleil.
4. Éviter que des liquides et des petits objets métalliques pénètrent à l'intérieur de l'appareil. En cas d'accident, débrancher l'appareil et le confier à un centre de service agréé NEC.
5. Ne pas frapper ou rayer la surface de la écran plasma, car des défauts risquent de se produire sur la surface de la écran plasma.
6. Pour effectuer une installation et un montage corrects, il est recommandé de faire appel au concessionnaire NEC autorisé et spécialisé.
7. Comme c'est le cas pour tout affichage à base de phosphore (comme un moniteur CRT, par exemple), la puissance de lumière baisse graduellement au cours de la vie du Panneau d'Affichage à Plasma.

Limited Warranty Plasma Monitors

NEC Technologies, Inc. (hereinafter NECTECH) warrants this product to be free from defects in material and workmanship under the following terms and, subject to the conditions set forth below, agrees to repair or replace (at NECTECH's sole option) any part of the enclosed unit which proves defective. Replacement parts or products may be new or refurbished and will meet specifications of the original parts or products.

HOW LONG IS THE WARRANTY?

Parts and labor are warranted for (1) one year from the date of the first customer purchase.

WHO IS PROTECTED?

This warranty may be enforced only by the first purchaser.

WHAT IS COVERED AND WHAT IS NOT COVERED

Except as specified below, this warranty covers all defects in material or workmanship in this product. The following are not covered by the warranty:

1. Any product which is not distributed in the U.S.A., Canada or Mexico by NECTECH or which is not purchased in the U.S.A., Canada or Mexico from an authorized NECTECH dealer.
2. Any product of which the serial number has been defaced, modified or removed.
3. Damage, deterioration or malfunction resulting from:
 - a. Accident, misuse, abuse, neglect, fire, water, lightning or other acts of nature, unauthorized product modification, or failure to follow instructions supplied with the product.
 - b. Repair or attempted repair by anyone not authorized by NECTECH.
 - c. Any shipment of the product (claims must be presented to the carrier).
 - d. Removal or installation of the product.
 - e. Any other cause which does not relate to a product defect.
 - f. Burns or residual images upon the phosphor of the panel.
4. Cartons, carrying cases, batteries, external cabinets, magnetic tapes, or any accessories used in connection with the product.
5. Service outside of the U.S.A. and Canada.

WHAT WE WILL PAY FOR AND WHAT WE WILL NOT PAY FOR

We will pay labor and material expenses for covered items, but we will not pay for the following:

1. Removal or installation charges.
2. Costs of initial technical adjustments (set-up), including adjustment of user controls. These costs are the responsibility of the NECTECH dealer from whom the product was purchased.
3. Shipping charges.

HOW YOU CAN GET WARRANTY SERVICE

1. To obtain service on your product, consult the dealer from whom you purchased the product.
2. Whenever warranty service is required, the original dated invoice (or a copy) must be presented as proof of warranty coverage. Please also include in any mailing your name, address and a description of the problem(s).
3. For the name of the nearest NECTECH authorized service center, call NECTECH at 800-836-0655.

LIMITATIONS OF LIABILITY

Except for the obligations specifically set forth in this warranty statement, we will not be liable for any direct, indirect, special, incidental, consequential, or other types of damages, whether based on contract, tort, or any other legal theory, whether or not we have been advised of the possibility of such damages. This warranty is in lieu of all other warranties expressed or implied, including, but not limited to, the implied warranties of merchantability or fitness for a particular purpose.

EXCLUSION OF DAMAGES

NECTECH's liability for any defective product is limited to the repair or replacement of the product at our option. NECTECH shall not be liable for:

1. Damage to other property caused by any defects in this product, damages based upon inconvenience, loss of use of the product, loss of time, commercial loss; or
2. Any other damages whether incidental, consequential or otherwise. Some states do not allow limitation on how long an implied warranty lasts and/or do not allow the exclusion or limitation of incidental or consequential damages, so the above limitations and exclusions may not apply to you.

HOW STATE LAW RELATES TO THE WARRANTY

This warranty gives you specific legal rights, and you may also have other rights which vary from state to state.

FOR MORE INFORMATION,
TELEPHONE 800-836-0655
NEC TECHNOLOGIES, INC.
1250 N. Arlington Heights Road, Suite 500
Itasca, Illinois 60143-1248

Note: All products returned to NECTECH for service MUST have prior approval. To get approval, call NEC Technologies at 800-836-0655.

Contents

How to Attach Options to the Plasma Monitor	1	OSM Controls	17
Introduction	2	Menu Operations	17
Introduction to the PlasmaSync 61MP1		Picture Settings Menu	19
Plasma Monitor	2	Adjusting the picture	19
The features you'll enjoy include:	2	Setting the picture mode according to the	
Contents of the Package	2	brightness of the room	20
Options	2	Setting the color temperature	21
Part Names and Function	3	Adjusting the color to the desired quality	22
Front View	3	Reducing noise in the picture	23
Rear View / Terminal Board	4	Sound Settings Menu	24
Remote Control	5	Adjusting the treble, bass and left/right balance	24
Battery Installation and Replacement	6	Screen Settings Menu	25
Using the wired remote control mode	7	Adjusting the Position, Size, Fine Picture,	
Operating Range	7	Picture Adj	25
Handling the remote control	7	Function Settings Menu	26
Installation	8	Setting the on-screen menu	26
Connecting Your PC or Macintosh Computer	9	Adjusting the position of the menu display	27
Connections with Equipment that has a Digital Interface ...	9	Setting the power management for computer images ..	28
Connecting Your Document Camera	9	POWER/STANDBY indicator	29
Connecting Your VCR or Laser Disc Player	9	Setting the gray level for the sides of the screen	30
Connecting Your DVD Player	9	Setting the picture to suit the movie	30
External Speaker Connections	10	Setting RGB3 ADJ	31
Pin Assignments and Signal Levels		Reducing burn-in of the screen	31
for 15 pin RGB (Analog)	11	Resetting to the default values	32
Pin Configuration and Signal		Option Settings Menu	33
of the RGB 3 IN Connector (DVI Connector)	11	Setting the allocation of the audio connectors	33
Basic Operations	12	Setting the BNC connectors	33
POWER	12	Setting a computer image to the correct RGB	
To turn the unit ON and OFF:	12	select screen	34
VOLUME	12	Setting high definition images to the suitable	
To adjust the volume:	12	screen size	35
MUTE	12	Setting the picture size for RGB input signals	36
To cancel the sound:	12	Information Menu	36
DISPLAY	12	Checking the frequencies, polarities of input signals,	
To check the settings:	12	and resolution	36
DIGITAL ZOOM	12	Setting the language for the menus	37
AUTO ADJUST	12	Setting the video signal format	37
To adjust the size or quality of the picture		External Control	39
automatically:	12	Table of Signals Supported	47
OFF TIMER	13	Supported resolution	47
To set the off timer:	13	Troubleshooting	49
To check the remaining time:	13	Specifications	50
To cancel the off timer	13		
WIDE Operations	14		
Watching with a wide screen (manual)	14		
When watching videos or digital video discs	14		
When watching high definition video source	14		
Watching computer images with a wide screen	15		
When "PICTURE SIZE" is set to "OFF"	15		
MULTI SCREEN Operations	16		
Showing a couple of pictures on the screen			
at the same time	16		
Selecting the input signals to be displayed	16		
Adjusting the OSM controls	16		

How to Attach Options to the Plasma Monitor

You can attach your optional mounts or stand to the plasma monitor in the following way:

- * Unpack the plasma monitor. (See Drawing A.)
- * Take it out, put your hand in the handy-grip recess at the rear, and move it to an appropriate place. Then attach the optional mounts or stand. (See Drawing B.)

• **This device cannot be installed on its own. Be sure to use a stand or original mounting unit. (Wall mount unit, Stand, etc.)**

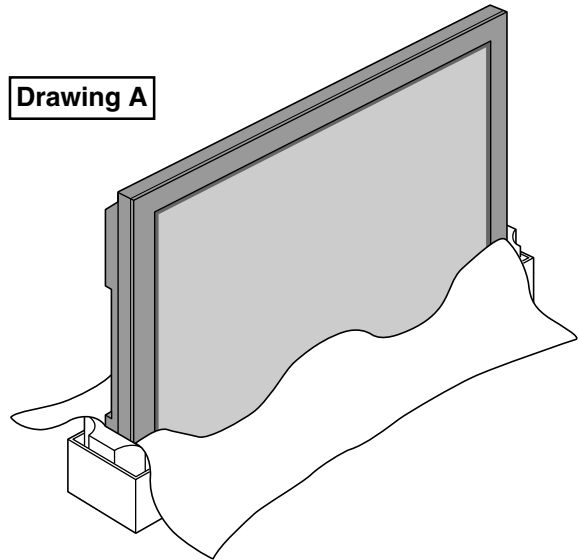
* **See page 2.**

• **For correct installation and mounting it is strongly recommended to use a trained, authorized NEC dealer.**

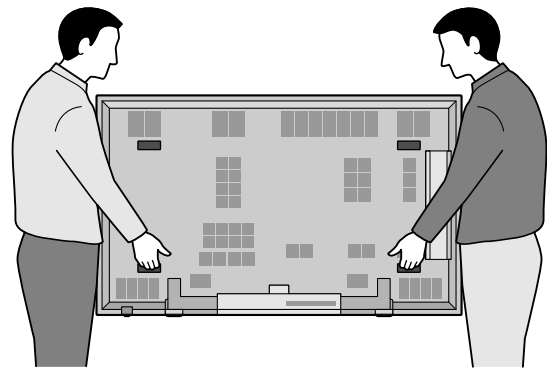
Failure to follow correct mounting procedures could result in damage to the equipment or injury to the installer.

Product warranty does not cover damage caused by improper installation.

Drawing A

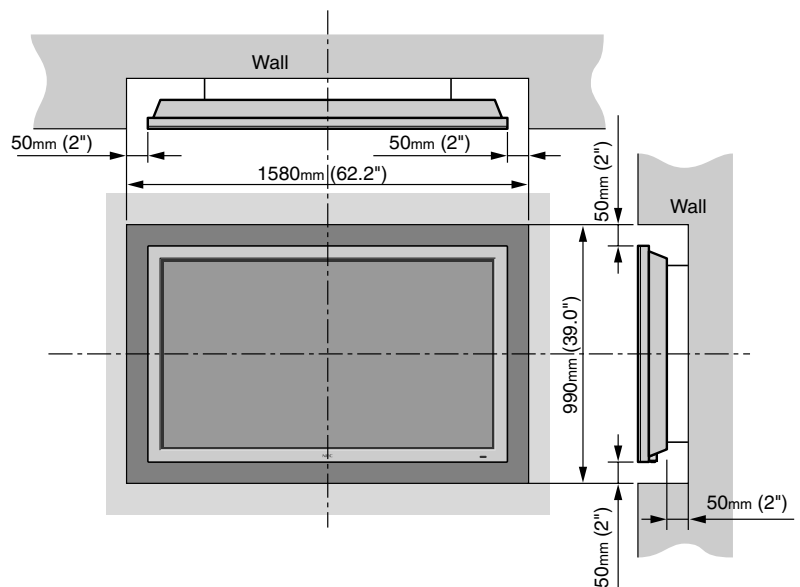


Drawing B



Ventilation Requirements for enclosure mounting

To allow heat to disperse, leave space between surrounding objects as shown on the diagram below when installing.



Introduction

Introduction to the PlasmaSync 61MP1 Plasma Monitor

NEC's PlasmaSync™ is a seamless blend of cutting-edge visual technology and sophisticated design. At 61-inches, with a 16:9 aspect ratio, the PlasmaSync 61MP1 certainly makes a big impression. However, at a mere 4.7 inches/119 mm thin, the monitor's sleek techno-art lines blend in well with your environment. PlasmaSync's crisp, vivid image quality will transform data from any graphic medium from PCs to DVD players- into art. And weighing only 134.5 lbs/ 61 kg, it actually can be hung almost anywhere. NEC has made sure that a host of multimedia resources can be easily connected and displayed as brilliantly as intended on the PlasmaSync™ monitor.

The features you'll enjoy include:

- 61-inch screen
- 16:9 aspect ratio
- Capsulated Color Filter (CCF) and black matrix
- The enhanced display in red uses a two-stage filtering system where Accurimson™ is combined with our special CCF.
- 4.7 inch / 119 mm thin
- 134.5 lbs/ 61 kg light
- High-resolution screen: 1365 × 768 pixels
- 160-degrees of off-axis viewing, horizontally and vertically.
- Flicker - and warp - free display provides excellent image geometry even in screen corners
- Not affected by magnetic fields, no color drift or edge distortion.
- VGA, SVGA, XGA, SXGA, computer signal compatibility
- NTSC, PAL, SECAM, composite and S-Video signal compatibility
- 480P, 1080I, 720P and HDTV signal compatibility
- PCs, VCRs, Laser Disc and DVD player source compatibility
- AccuBlend™ scan conversion automatically converts VGA, SVGA and SXGA signals to the panel's native resolution
- Advanced Mass Area Sampling Progressive Scan method is employed.
- RGB input (3*), Video input (3), DVD/HD input (2*), Audio input (3), External Control input (1)
- AccuColor control system provides user selectable on-screen color temperature settings
- New Drive Technology
- Component video input terminal for DVD, 15.75kHz (Y, CB, CR)
- Digital broadcasting source compatibility
- NEC's OSM™ menu-driven on screen control system that makes image adjustments a snap
- Seven languages (English, German, French, Italian, Spanish, Swedish, and Japanese)
- A handy-grip recess is provided to facilitate installation and movement.

* You can select RGB source or Component source for the 5BNC terminal. When selecting an RGB input, the source is switched to the RGB input (3); when selecting a component input, the source is switched to the DVD/HD input (2).

Contents of the Package

- PlasmaSync™ 61MP1 plasma monitor
- Power cord
- RGB cable (Mini D-Sub 15-pin to Mini D-Sub 15-pin connector)
- Remote control with two AAA Batteries
- User's manual
- Remote cable
- Safety metal fittings*
- Ferrite core (small × 2, large × 2), band

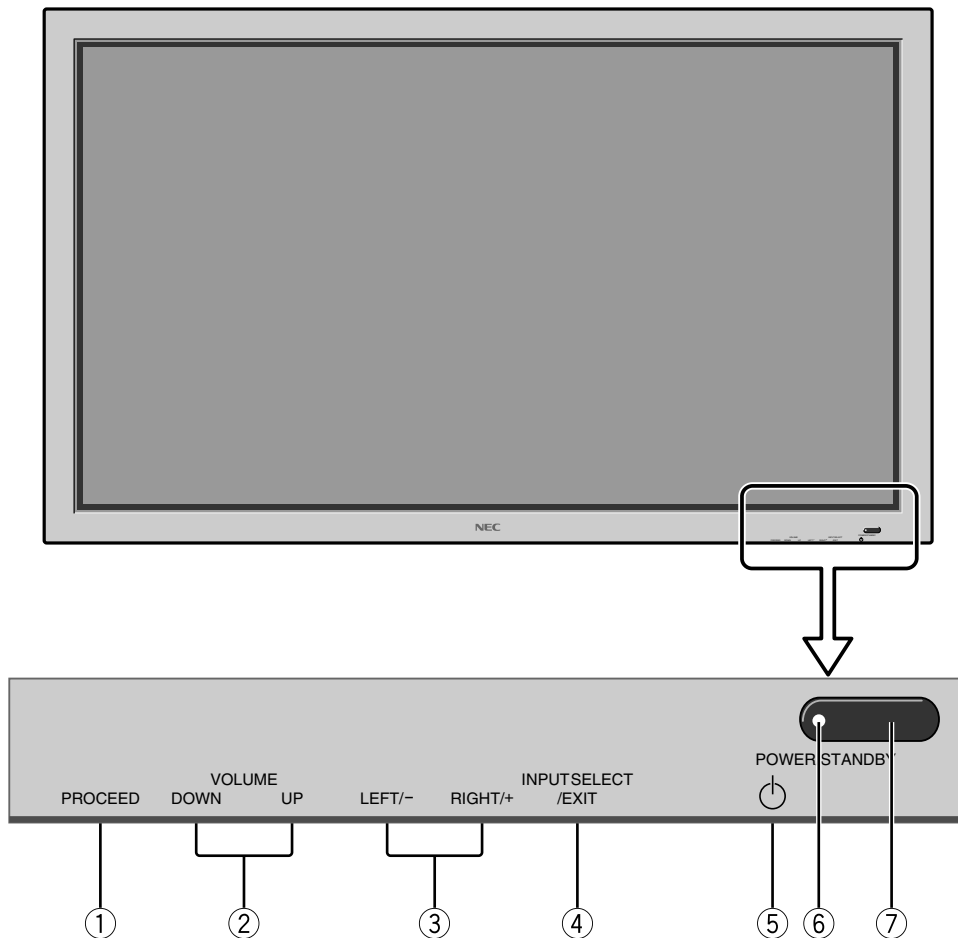
* These are fittings for fastening the unit to a wall to prevent tipping due to external shock when using the stand (option). Screw the safety fittings to the holes in the back of the monitor.

Options

- Wall mount unit
- Ceiling mount unit
- Tilt mount unit
- Tabletop stand
- Speakers
- Others

Part Names and Function

Front View



① **PROCEED**

Sets the On-Screen Menu (OSM) mode and displays the main menu.

② **VOLUME DOWN and UP**

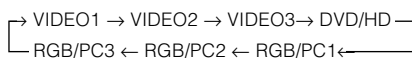
Adjusts the volume. Functions as the CURSOR (▲/▼) buttons in the On-Screen Menu (OSM) mode.

③ **LEFT/- and RIGHT/+**

Enlarges or reduces the image. Functions as the CURSOR (◀/▶) buttons in the On-Screen Menu (OSM) mode.

④ **INPUT SELECT / EXIT**

Switches the input, in the following order:



Functions as the EXIT buttons in the On-Screen Menu (OSM) mode.

⑤ **Power**

Turns the monitor's power on and off.

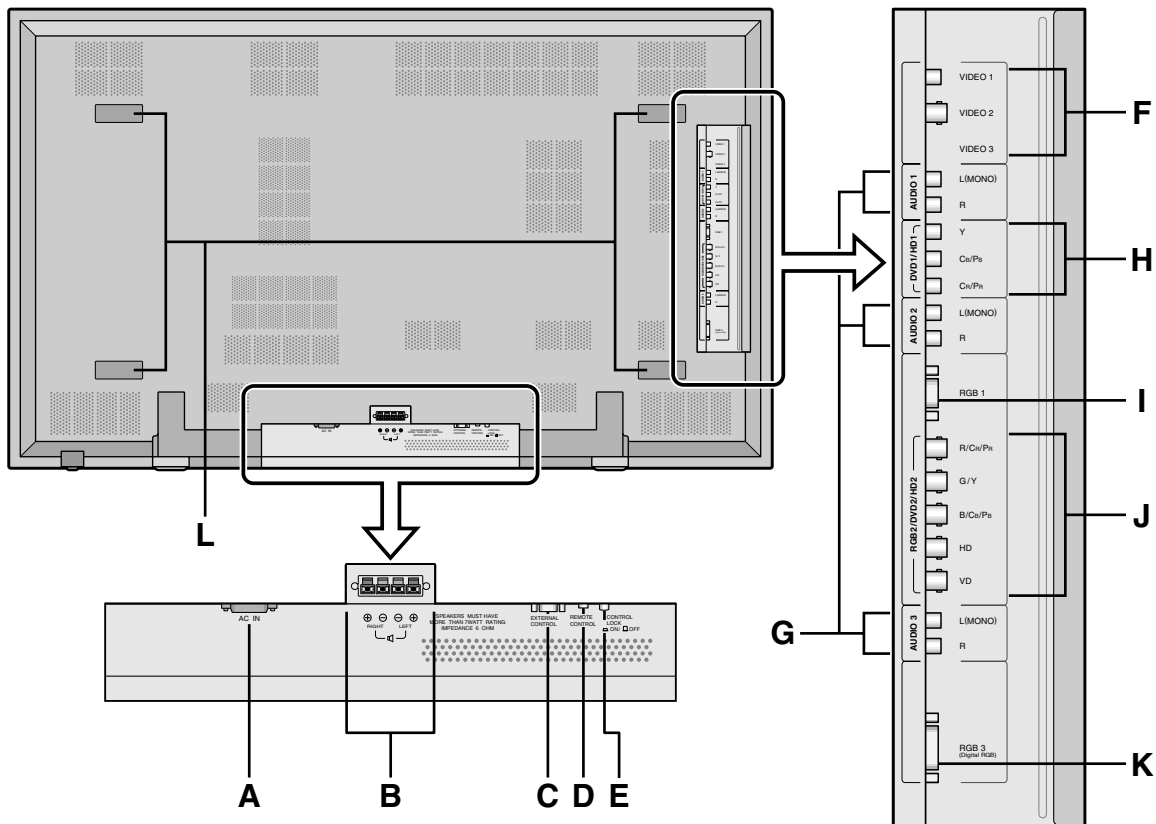
⑥ **POWER/STANDBY indicator**

When the power is on Lights green.
When the power is in the standby mode ... Lights red.

⑦ **Remote sensor window**

Receives the signals from the remote control.

Rear View/ Terminal Board



A AC IN

Connect the included power cord here.

B EXT SPEAKER L and R

Connect speakers here. Maintain the correct polarity.

C EXTERNAL CONTROL

This terminal is used when power ON/OFF, input selection and AUDIO MUTE and other controls are operated externally (by external control). See also page 39 for external control.

D REMOTE CONTROL

Connect the supplied remote cable here.

E CONTROL LOCK

When "CONTROL LOCK" is set "ON", the buttons on the set's control panel do not function.

F VIDEO1, 2, 3

Connect VCR's, DVD's or Laser Discs, etc. here.

G AUDIO1, AUDIO2, AUDIO3

These are audio input terminals.

The input is selectable. Set which video image to allot them to on the menu screen.

H DVD1 / HD1

Connect DVD's, High Definition or Laser Discs, etc. here.

I RGB1

Inputs the analog RGB signal of personal computer, etc.

J RGB2/ DVD2/ HD2

RGB2: Inputs the analog RGB signal.

DVD2/ HD2: Connect DVD's, High Definition or Laser Discs, etc. here.

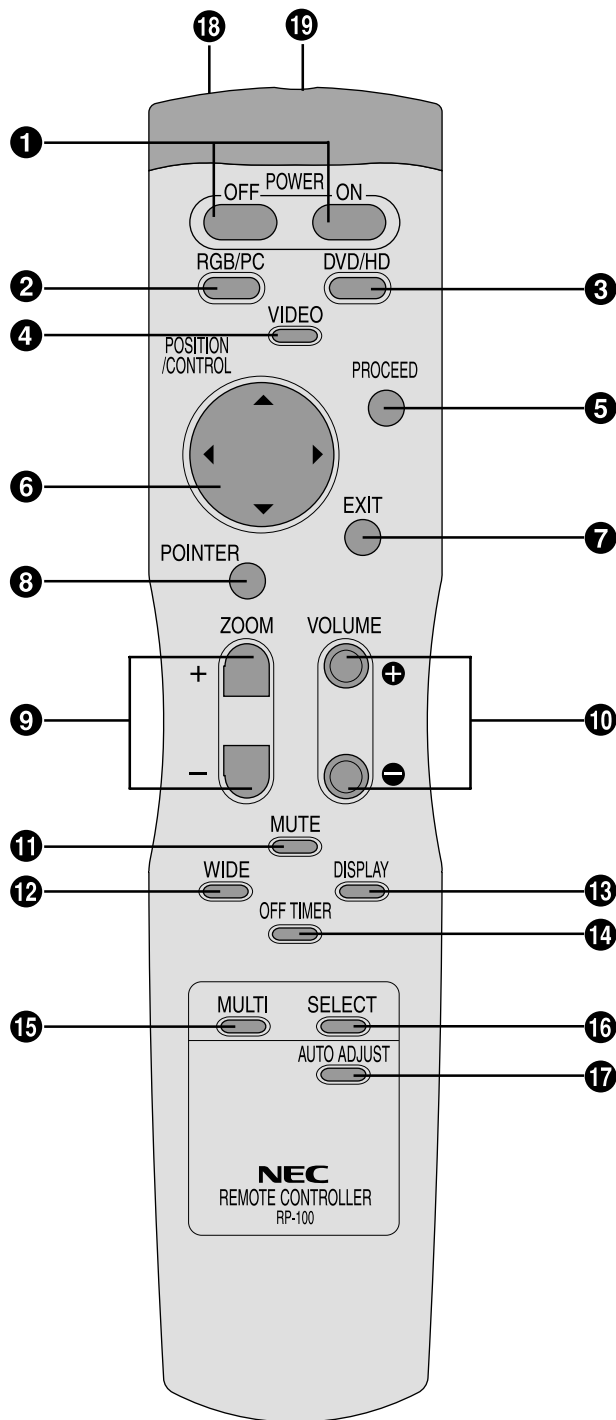
K RGB3 (DVI 29pin)

Inputs a digital RGB signal (TMDS).

L Handy-Grip recess

Use the recesses (as shown) when you need to carry the display.

Remote Control



1 POWER ON/OFF

Switches Power ON/OFF.
(This does not operate when POWER/STANDBY indicator of the main unit is off.)

2 RGB/PC

Press this button to select RGB/PC as the source.

→ RGB/PC1 → RGB/PC2 → RGB/PC3 →

RGB/PC can also be selected using the INPUT SELECT button on the monitor. The input switches as follows each time the button is pressed:

→ VIDEO1 → VIDEO2 → VIDEO3 → DVD/HD →
RGB/PC3 ← RGB/PC2 ← RGB/PC1 ←

3 DVD / HD

Press this button to select DVD/HD as the source.
DVD/HD can also be selected using the INPUT SELECT button on the monitor. The input switches as follows each time the button is pressed:

→ VIDEO1 → VIDEO2 → VIDEO3 → DVD/HD →
RGB/PC3 ← RGB/PC2 ← RGB/PC1 ←

4 VIDEO

Press this button to select VIDEO as the source.

→ VIDEO1 → VIDEO2 → VIDEO3 →

VIDEO can also be selected using the INPUT SELECT button on the monitor. The input switches as follows each time the button is pressed:

→ VIDEO1 → VIDEO2 → VIDEO3 → DVD/HD →
RGB/PC3 ← RGB/PC2 ← RGB/PC1 ←

5 PROCEED

Press this button to access the OSM controls.
Press this button during the display of the main menu to go to the sub menu.

6 CURSOR (▲ / ▼ / ◀ / ▶)

Use these buttons to select items or settings and to adjust settings or switch the display patterns.

7 EXIT

Press this button to exit the OSM controls in the main menu. Press this button during the display of the sub menu to return to the main menu.

8 POINTER

Press this button to display the pointer.

9 ZOOM (+ / -)

Enlarges or reduces the image.

10 VOLUME (+ / -)

Adjusts the volume.

11 MUTE

Mutes the sound.

12 WIDE

The type of broadcast is detected automatically, and the recommended wide screen is set.

13 DISPLAY

Displays the source settings on the screen.

14 OFF TIMER

Activates the off timer for the unit.

15 MULTI

Press this button to select a screen mode from among single mode, side by side, and picture in picture.

16 SELECT

Press this button to select the active picture in a multi screen mode.

17 AUTO ADJUST

Press this button to adjust Fine Picture, Picture ADJ, Position, and Contrast automatically, or to switch the screen size to ZOOM mode automatically with the superimposed caption displayed fully only when the picture contains dark areas above and below the picture.

18 Remote control signal transmitter

Transmits the remote control signals.

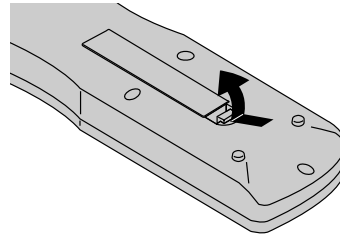
19 Remote Jack

Insert the plug of the supplied remote cable here when using the supplied remote control in the wired condition.

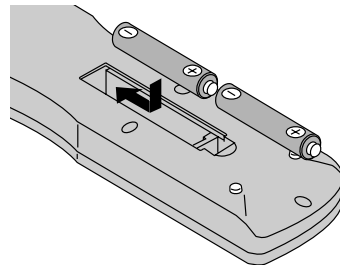
Battery Installation and Replacement

Insert the 2 “AAA” batteries, making sure to set them in with the proper polarity.

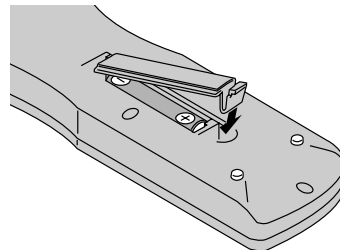
1. Press and open the cover.



2. Align the batteries according to the (+) and (-) indication inside the case.



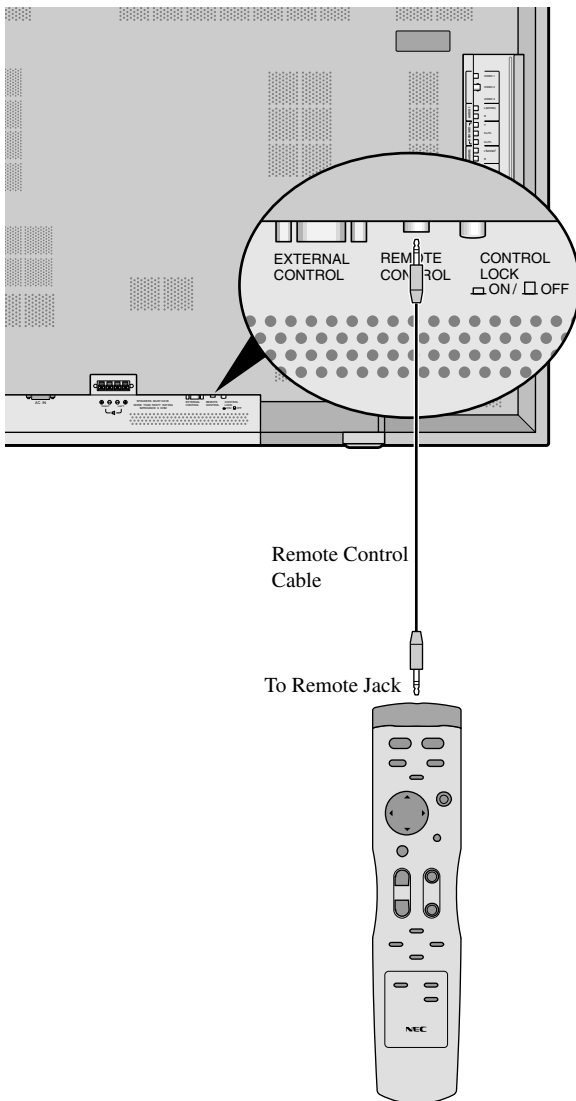
3. Replace the cover.



Using the wired remote control mode

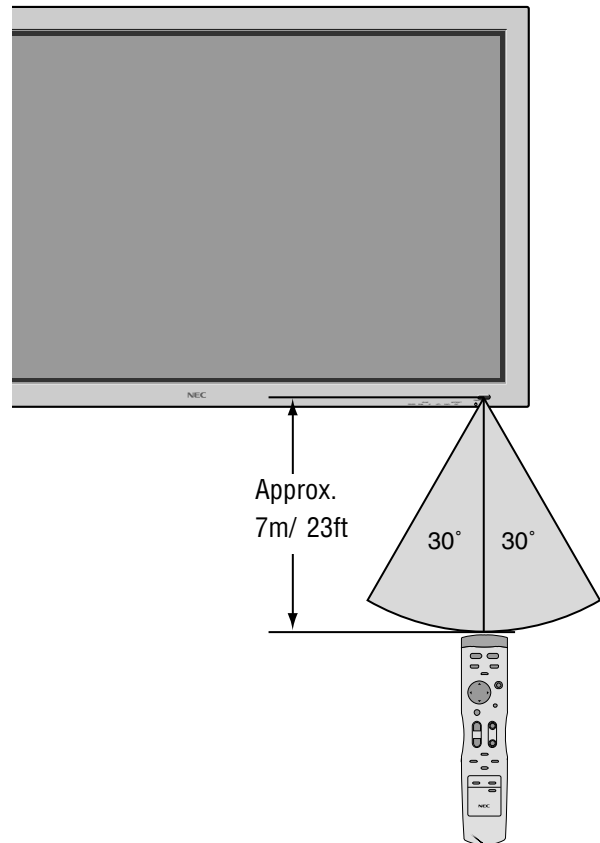
Connect the supplied remote cable to the remote control's remote jack and the "REMOTE CONTROL" terminal on the monitor.

When the cable is connected, the mode automatically switches to wired remote control. When the wired remote control mode is used, the remote control can be operated even if no batteries are loaded.



Operating Range

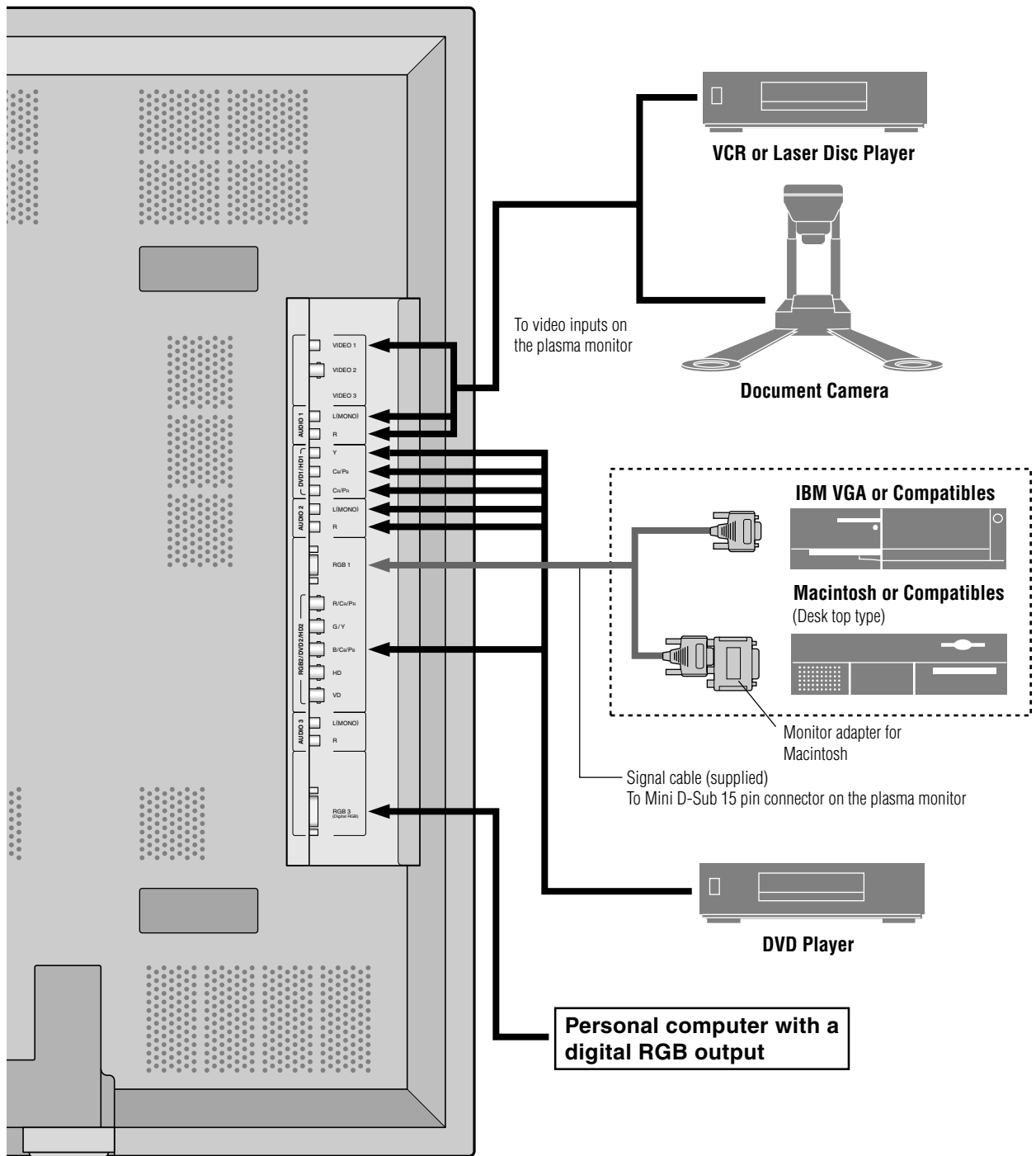
- * Use the remote control within a distance of about 7 m/ 23ft. from the front of the monitor's remote control sensor and at horizontal and vertical angles of up to approximately 30°.
- * The remote control operation may not function if the monitor's remote control sensor is exposed to direct sunlight or strong artificial light, or if there is an obstacle between the sensor and the remote control.



Handling the remote control

- Do not drop or mishandle the remote control.
- Do not get the remote control wet. If the remote control gets wet, wipe it dry immediately.
- Avoid heat and humidity.
- When not using the remote control for a long period, remove the batteries.
- Do not use new and old batteries together, or use different types together.
- Do not take apart the batteries, heat them, or throw them into a fire.
- When using the remote control in the wireless condition, be sure to unplug the remote cable from the REMOTE CONTROL terminal on the monitor.

Installation



Connecting Your PC or Macintosh Computer

Connecting your PC or Macintosh computer to your plasma monitor will enable you to display your computer's screen image for an impressive presentation. The plasma monitor supports the signals described on page 47.

To connect a PC, Macintosh or compatible graphics adapter, simply:

1. Turn off the power to your plasma monitor and computer.
2. If your PC does not support XGA/SVGA/VGA you will need to install an XGA/SVGA/VGA graphics board. Consult your computer's owner's manual for your XGA/SVGA/VGA configuration. If you need to install a new board, see the manual that comes with your new graphics board for installation instructions.
3. The plasma monitor provides signal compatibility up to VESA 1600 × 1200 (UXGA). However, it is not recommended to use this resolution due to image readability on the monitors 1365 × 768 native pixel resolution panel.
4. Use the signal cable that's supplied to connect your PC or Macintosh computer to the plasma monitor. For Macintosh, use the monitor adapter to connect to your computer's video port.
5. Turn on the plasma monitor and the computer.
6. If the plasma monitor goes blank after a period of inactivity, it may be caused by a screen saver installed on the computer you've connected to the plasma monitor.

When using a Macintosh with the plasma monitor, the following four display standards are supported using the Macintosh adapter :

- 13" fixed mode
- 16" fixed mode
- 19" fixed mode
- 21" fixed mode

The 19" fixed mode is recommended for the plasma monitor.

Connections with Equipment that has a Digital Interface

Connections can be made with equipment that is equipped with a digital interface compliant with the DVI (Digital Visual Interface) standard.

* Use a DVI 29-pin signal cable and the ferrite cores (supplied) when making connections to the RGB3 IN (DVI) connector of the main unit.

Note that the RGB3 IN(DVI) terminal does not support analog RGB input source.

Note:

1. Input TMDS signals conforming to DVI standards. The TMDS input corresponds to 1 link.
2. To maintain display quality, use a cable with a quality prescribed by DVI standards that is within 5 meters in length.

Connecting Your Document Camera

You can connect your plasma monitor to a document camera. To do so, simply:

1. Turn off the power to your plasma monitor and document camera.
2. Use a standard video cable to connect your document camera to the Video input on your plasma monitor.
3. Turn on the plasma monitor and the document camera.

Note: Refer to your document camera owner's manual for more information about your camera's video output requirements.

Connecting Your VCR or Laser Disc Player

Use common RCA cables (not provided) to connect your VCR or laser disc player to your plasma monitor. To make these connections, simply:

1. Turn off the power to your plasma monitor and VCR or laser disc player.
2. Connect one end of your RCA cable to the video output connector on the back of your VCR or laser disc player, connect the other end to the Video input on your plasma monitor. Use standard RCA audio patch cords to connect the audio from your VCR or laser disc player to your plasma monitor (if your VCR or laser disc player has this capability). Be careful to keep your right and left channel connections correct for stereo sound.
3. Turn on the plasma monitor and the VCR or laser disc player.

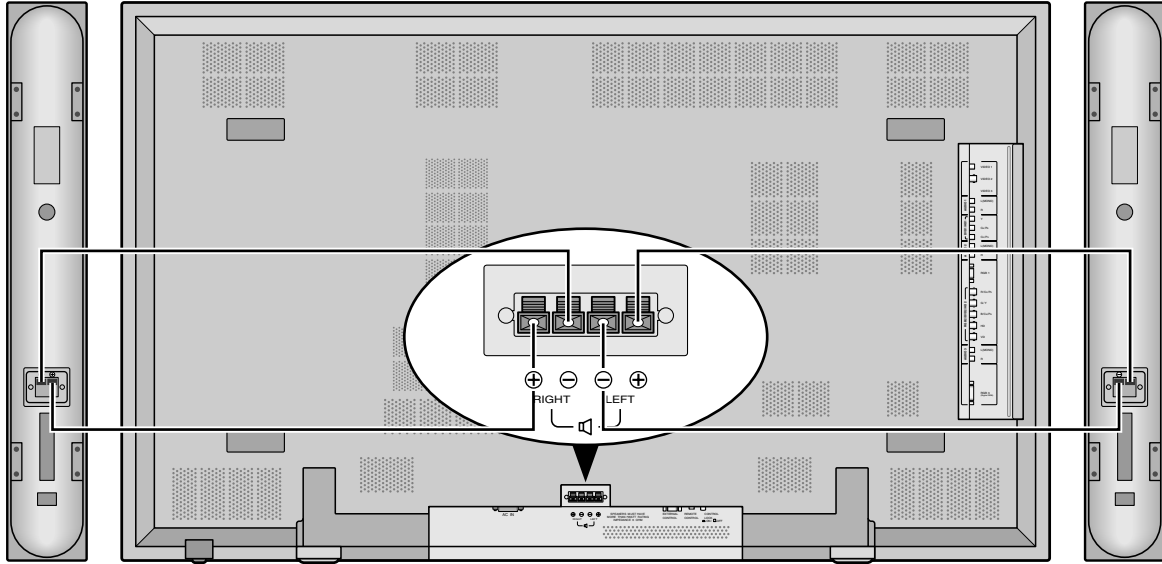
Note: Refer to your VCR or laser disc player owner's manual for more information about your equipment's video output requirements.

Connecting Your DVD Player

You can connect your plasma monitor to a DVD player. To do so, simply:

1. Turn off the power to your plasma monitor and DVD player.
2. Use a standard video cable to connect your DVD player to the Y, Cb, and Cr inputs on your plasma monitor. Or use the DVD-player's S-Video output. Use a standard S-Video cable to connect to the S-Video input on the plasma monitor.
3. Turn on the plasma monitor and the DVD player.

External Speaker Connections



External speakers may be connected to the plasma monitor to reproduce sound from VIDEO, DVD or RGB signal sources.

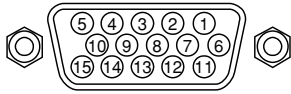
External speakers may be connected directly to the SPEAKERS terminals or indirectly by connecting a stereo system amplifier to the audio outputs.

CAUTION: *Unplug the plasma monitor and all connected components before connecting external speakers. Use only speakers with 6-ohm impedance and a power input rating of 7 watts or more.*

To connect external speakers directly to the plasma monitor:

1. Strip the ends of the speaker wires.
2. Press down the tabs below the SPEAKERS terminals, insert the speaker wire and release the tab to secure the speaker wire connection:
 - [a] Connect the right speaker (located at right side of the monitor when viewed from the front) positive (+) wire to RIGHT +.
 - [b] Connect the right speaker negative (-) wire to RIGHT -.
 - [c] Connect the left speaker negative (-) wire to LEFT-.
 - [d] Connect the left speaker positive (+) wire to LEFT+.

Pin Assignments and Signal Levels for 15 pin RGB (Analog)



Pin No.	Signal (Analog)
1	Red
2	Green or sync-on-green
3	Blue
4	No connection
5	Ground
6	Red ground
7	Green ground
8	Blue ground
9	No connection
10	Sync signal ground
11	No connection
12	Bi-directional DATA (SDA)
13	Horizontal sync or Composite sync
14	Vertical sync
15	Data clock

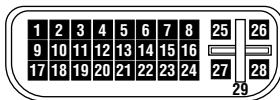
Pin Configuration and Signal of the RGB 3 IN Connector (DVI Connector)

The unit is equipped with a type of connector commonly used for both analog and digital.

(Functionally, this cannot be used for an analog input.)

(TMDS can be used for one link only.)

RGB 3



Pin No.	Signal (Digital)
1	T.M.D.S Data 2 -
2	T.M.D.S Data 2 +
3	T.M.D.S Data 2 Shield
4	No connection
5	No connection
6	DDC Clock
7	DDC Data
8	No connection
9	T.M.D.S Data 1 -
10	T.M.D.S Data 1 +
11	T.M.D.S Data 1 Shield
12	No connection
13	No connection
14	+5V Power
15	Ground
16	Hot Plug Detect
17	T.M.D.S Data 0 -
18	T.M.D.S Data 0 +
19	T.M.D.S Data 0 Shield
20	No connection
21	No connection
22	T.M.D.S Clock Shield
23	T.M.D.S Clock +
24	T.M.D.S Clock -
25	No connection
26	No connection
27	No connection
28	No connection
29	No connection

Basic Operations

POWER

To turn the unit ON and OFF:

1. Plug the power cord into an active AC power outlet.
2. Press the POWER ON button (on the remote control) to turn on the unit.

The monitor's POWER/STANDBY indicator will light up (green) when the unit is on.

3. Press the POWER OFF button (on the remote control or the unit) to turn off the unit.

The monitor's POWER/STANDBY indicator turns red and the standby mode is set (only when turning off the unit with the remote control).

VOLUME

To adjust the volume:

1. Press and hold the VOLUME ⊕ button (on the remote control or the unit) to increase to the desired level.
2. Press and hold the VOLUME ⊖ button (on the remote control or the unit) to decrease to the desired level.

MUTE

To cancel the sound:

Press the MUTE button on the remote control to cancel the sound; press again to restore.


DISPLAY

To check the settings:

1. The screen changes each time the DISPLAY button is pressed.
2. If the button is not pressed for approximately three seconds, the menu turns off.


DIGITAL ZOOM

Digital zoom specifies the picture position and enlarges the picture.

1. Press the POINTER button to display the pointer. ()

To change the size of the picture:

Press the ZOOM+ button and enlarge the picture.

The pointer will change to resemble a magnifying glass. ()

A press of the ZOOM- button will reduce the picture and return it to its original size.

To change the picture position:

Select the position with the ▲▼◀▶ buttons.

2. Press the POINTER button to delete the pointer.

AUTO ADJUST

To adjust the size or quality of the picture automatically:

Press the AUTO ADJUST button.

Information

■ AUTO ADJUST ON setting

When RGB (still picture) input is selected Fine Picture, Picture ADJ, Position, and Contrast will be adjusted automatically.

When RGB (motion picture), VIDEO, or Y/Pb/Pr (component) input is selected The screen size switches to ZOOM mode automatically with the superimposed caption displayed fully only when the picture contains dark areas above and below the picture.

OFF TIMER

To set the off timer:

The off timer can be set to turn the power off after 30, 60, 90 or 120 minutes.

1. Press the OFF TIMER button to start the timer at 30 minutes.
2. Press the OFF TIMER button to the desired time.
3. The timer starts when the menu turns off.

→ 30 → 60 → 90 → 120 → 0



OFF TIMER30

To check the remaining time:

1. Once the off timer has been set, press the OFF TIMER button once.
2. The remaining time is displayed, then turns off after a few seconds.
3. When five minutes remain the remaining time appears until it reaches zero.



OFF TIMER28

To cancel the off timer:

1. Press the OFF TIMER button twice in a row.
2. The off timer is canceled.



OFF TIMER0

Note:

After the power is turned off with the off timer ... A slight current is still supplied to the monitor. When you are leaving the room or do not plan to use the system for a long period of time, turn off the power of the monitor.

WIDE Operations

Watching with a wide screen (manual)

With this function, you can select one of four screen sizes.

When watching videos or digital video discs

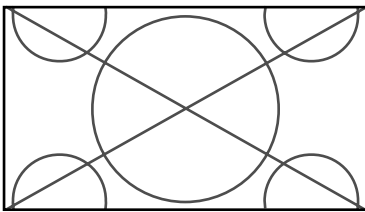
1. Press the WIDE button on the remote control.
2. *Within 3 seconds ...*

Press the WIDE button again.

The screen size switches as follows:

→ ZOOM → NORMAL → FULL → STADIUM →

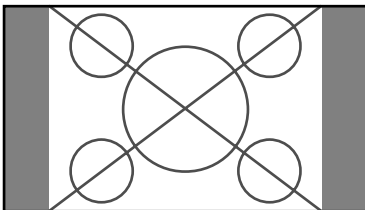
ZOOM size screen



The picture is expanded in the horizontal and vertical direction, maintaining the original proportions.

* Use this for theater size (wide) movies, etc.

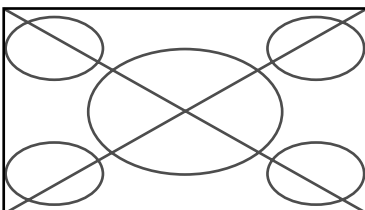
NORMAL size screen (4:3)



The normal size screen is displayed.

* The picture has the same size as video pictures with a 4 : 3 aspect ratio.

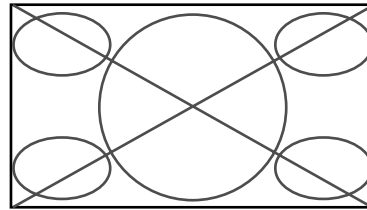
FULL size screen



The image is expanded in the horizontal direction.

* Images compressed in the horizontal direction (“squeezed images”) are expanded in the horizontal direction and displayed on the entire screen. (Normal images are expanded in the horizontal direction.)

STADIUM size screen



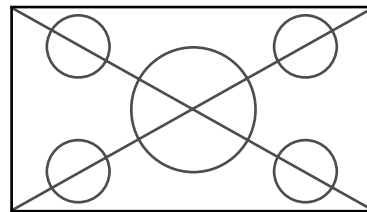
The picture is expanded in the horizontal and vertical directions at different ratios.

* Use this for watching normal video programs (4:3) with a wide screen.

When watching high definition video source

1. Press the WIDE button on the remote control.

FULL size screen (16 : 9)



The full size screen is displayed.

* The picture has the same size as video pictures (16 : 9).

Watching computer images with a wide screen

Switch to the wide screen mode to expand the 4 : 3 image to fill the entire screen.

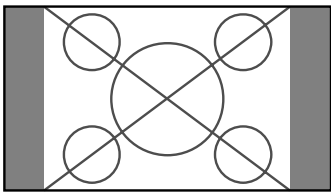
1. Press the WIDE button on the remote control.
2. *Within 3 seconds ...*

Press the WIDE button again.

The screen size switches as follows:

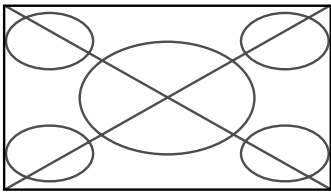
→ NORMAL → FULL ←

NORMAL size screen (4:3 or SXGA 5:4)



The picture has the same size as the normal computer image.

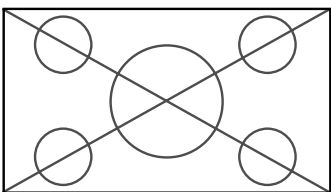
FULL size screen



The image is expanded in the horizontal direction.

When wide signals are input.

FULL size screen

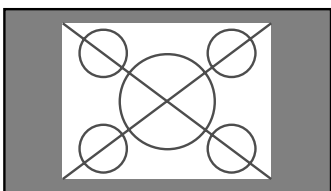


When "PICTURE SIZE" is set to "OFF"

The screen size switches as follows:

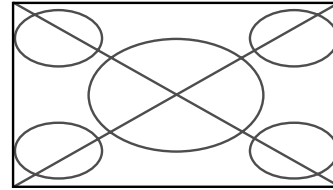
→ TRUE → FULL ←

TRUE size screen (VGA, SVGA 4:3)



The image is true resolution.

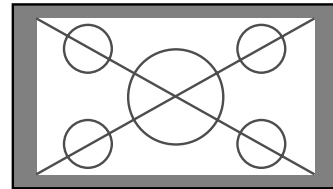
FULL size screen



The image is expanded in the horizontal and vertical direction.

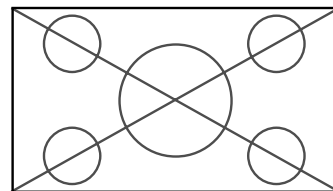
When wide signals are input.

TRUE



The image is true resolution.

FULL



Information

■ Supported resolution

See page 47 for details on the display output of the various VESA signal standards supported by the monitor.

■ "PICTURE SIZE" setting

When the setting of "PICTURE SIZE" is OFF, the size of RGB-input pictures will be TRUE in place of NORMAL.

■ When 852 (848) dot × 480 line wide VGA* signals with a vertical frequency of 60 Hz and horizontal frequency of 31.7 (31.0) kHz are input

Select an appropriate setting for RGB SELECT mode referring to the "Table of Signals Supported" on page 47.

* "IBM PC/AT" and "VGA" are registered trademarks of IBM, Inc. of the United States.

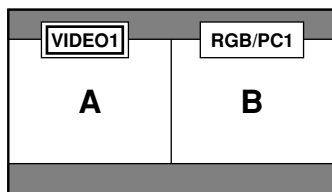
MULTI SCREEN Operations

Showing a couple of pictures on the screen at the same time

* An RGB-input picture may not be displayed in these modes, depending on the input signal specifications.

1. Press the MULTI button to select a screen mode from among single mode, side by side, and picture in picture.

Side by side 1

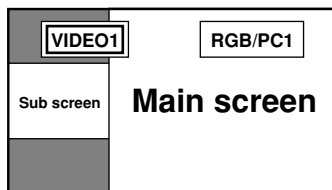


Press the cursor buttons ◀▶ on the remote control to switch either side by side 1 (with ▶) or side by side 2 (with ◀).

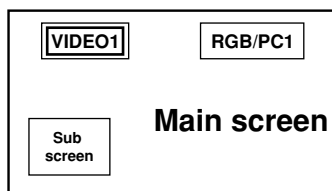
Note:

Picture A and B on the above screen are not always of the same height.

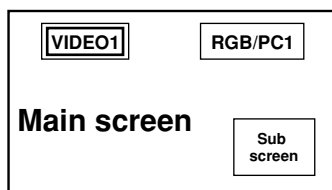
Side by side 2



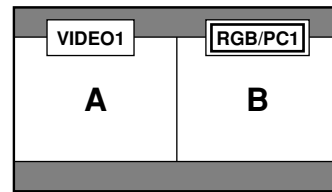
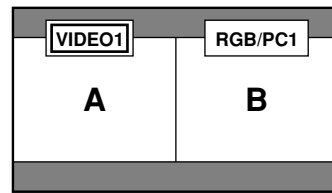
Picture in picture



Press the cursor buttons ◀▶ on the remote control to switch the position of the sub screen.



2. If you wish to switch the setting of the picture, press the SELECT button to make the desired picture active. Each press of the SELECT button changes the selection of the active picture.



Selecting the input signals to be displayed

1. Press the SELECT button to make the desired picture active.
2. Press the RGB/PC, VIDEO, or DVD/HD button. Each press of the button changes the selection of the input signal. The INPUT SELECT button on the monitor can also be used to change the selection.

Adjusting the OSM controls

1. Press the PROCEED button to display the MAIN MENU.
2. Adjust the setting to your preference. For details, see "OSM (On Screen Menu) Controls" on page 17.

Note:

During multi mode, Auto Adjust does not affect the screen.

Information

■ Positioning on the screen (for side by side)

Depending on the input-signal selection, positioning of the picture is settled as follows.

Pictures displayed

on the left VIDEO1, VIDEO2, VIDEO3, HD1/
DVD1/DTV1, or HD2/DVD2/
DTV2

Pictures displayed

on the right RGB/PC1, RGB/PC2, RGB/PC3

■ Positioning on the screen (for picture in picture)

Pictures displayed

Main screen RGB/PC1, RGB/PC2, RGB/PC3

Sub screen VIDEO1, VIDEO 2, VIDEO 3,
HD 1/DVD 1/DTV 1, or HD 2/
DVD 2/DTV 2

■ Multi screen operations may not function depending on the type of the RGB signals.

OSM(On Screen Menu) Controls

Menu Operations

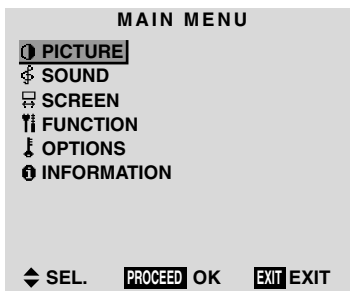
The OSM window is displayed with respect to the screen as shown on the diagram.

* Depending on the screen's mode, the OSM may be displayed differently.
In the explanation, the OSM section is shown close up.

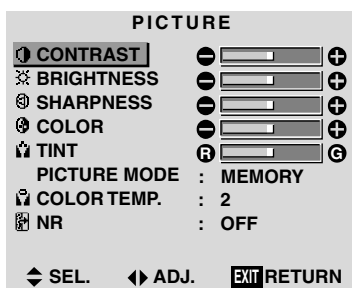


The following describes how to use the menus and the selected items.

1. Press the PROCEED button on the remote control to display the MAIN MENU.



2. Press the cursor buttons ▲ ▼ on the remote control to highlight the menu you wish to enter.
3. Press the PROCEED button on the remote control to select a submenu or item.



4. Adjust the level or change the setting of the selected item by using the cursor buttons ◀ ▶ on the remote control.

5. The change is stored until you adjust it again.
6. Repeat steps 2 – 5 to adjust an additional item, or press the EXIT button on the remote control to return to the main menu.

Note: The main menu disappears by pressing the EXIT button.

Main menu	Sub menu	Functions	Default	Reset
PICTURE	CONTRAST	Adjusts the contrast.	Center	Yes
	BRIGHTNESS	Adjusts the brightness.	Center	Yes
	SHARPNESS	Adjusts the sharpness.	Center	Yes
	COLOR	Adjusts the color.	Center	Yes
	TINT	Adjusts the tint.	Center	Yes
	PICTURE MODE	Sets the picture mode according to the VIDEO environment and image software.	MEMORY	Yes
	COLOR TEMP NR	Adjusts the color temperature and white balance. Reduces noise visible in image.	2*1 OFF	Yes Yes

Main menu	Sub menu	Functions	Default	Reset
SOUND	BASS	Sets the bass.	Center	Yes
	TREBLE	Sets the treble.	Center	Yes
	BALANCE	Sets the left/right balance.	Center	Yes

Main menu	Sub menu	Functions	Default	Reset
SCREEN	V-POSITION	Adjusts the vertical position.	Center	Yes
	H-POSITION	Adjusts the horizontal position.	Center	Yes
	V-HEIGHT	Adjusts the vertical size.	Min	Yes
	H-WIDTH	Adjusts the horizontal size.	Min	Yes
	AUTO PICTURE	Turn this on to have the monitor automatically adjust "FINE PICTURE" and "PICTURE ADJ".	OFF*1	No
	FINE PICTURE PICTURE ADJ.	Adjusts for flickering on the computer image. Adjusts for striped patterns on the computer image.	Min*1 Center*1	Yes Yes

Main menu	Sub menu	Functions	Default	Reset
FUNCTION	OSM	Turns the on-screen menu (screen mode, etc.) off (when set to "OFF"). When set to "ON", the on-screen menu is displayed.	ON	Yes
	OSM ADJ.	Adjusts the vertical and horizontal positions of the menu display.	1	Yes
	POWER MGT	Sets the monitor for use as an energy-saving display when used with a computer.	OFF	Yes
	GRAY LEVEL	In case of 4 : 3, sets the luminance of both sides.	3	Yes
	CINEMA MODE	Sets the picture to suit the movie.	ON	Yes
	RGB3 ADJ.	Adjusts the picture when the picture input from the RGB3 input terminal is distorted.	1	Yes
	LONG LIFE RESET	Sets the picture to reduce burn-in of the display. Resets all the settings (PICTURE, SOUND, SCREEN, FUNCTION, etc.) to the factory default values.	*2 —	Yes —

Main menu	Sub menu	Functions	Default	Reset
OPTION	AUDIO INPUT	Sets the allocation of the audio connectors.	*3	Yes
	BNC SELECT	Sets the BNC connectors.	RGB	Yes
	RGB SELECT	Sets the appropriate mode for the computer image. RGB (VGA signals), VIDEO (Moving picture), WIDE (WIDE VGA) DTV.	AUTO	Yes
	HD SELECT	Sets the digital broadcasting (1080A,1080B) or the High Vision (1035I).	1080B	No
	PICTURE SIZE	Sets the picture size for RGB input.	ON	Yes

Main menu	Sub menu	Functions	Default	Reset
INFORMATION	FREQUENCY	Used to check the frequency and synchronizing polarities of the signal currently being inputted.	—	—
	LANGUAGE	Sets the language of the menus (Japanese, English, German, French, Swedish, Italian or Spanish).	English	No
	COLOR SYSTEM	Sets the VIDEO format (AUTO1, AUTO2, PAL, PAL-M, PAL-N, PAL60, SECAM, 4.43 NTSC or 3.58 NTSC).	AUTO1	No

*1 RGB/PC only.

*2 PLE: AUTO ORBITER: OFF INVERSE: OFF

*3 AUDIO1: VIDEO1 AUDIO2: HD/DVD1 AUDIO3: RGB1

Picture Settings Menu

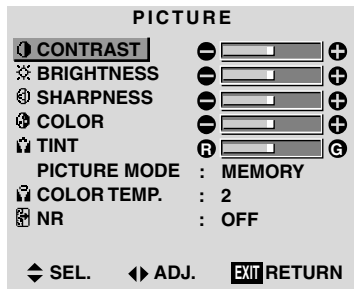
Adjusting the picture

The contrast, brightness, sharpness, color and tint can be adjusted as desired.

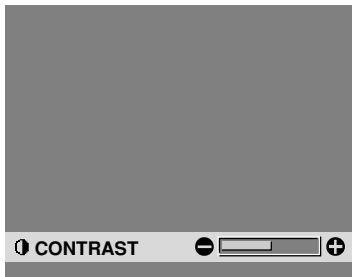
Example: Adjusting the contrast

Press the **PROCEED** button on the remote control to display the **MAIN MENU** on the screen, then...

1. Use the ▲ and ▼ buttons to select “PICTURE”, then press the **PROCEED** button. The “PICTURE” screen appears.
2. Use the ▲ and ▼ buttons to select “CONTRAST”.



3. Use the ◀ and ▶ buttons to adjust the contrast.



* If neither the ◀ or ▶ button is pressed within 5 seconds, the current setting is set and the previous screen reappears.

4. Once the adjustment is completed ...

Press the **EXIT** button to return to the main menu.

To delete the main menu, press the **EXIT** button once more.

Note: If “CAN NOT ADJUST” appears ...
When trying to enter the **PICTURE** submenu, make sure **PICTURE MODE** is set to **MEMORY**.

Information

Picture adjustment screen

CONTRAST Changes the picture’s contrast.
BRIGHTNESS .. Changes the picture’s brightness.
SHARPNESS .. Changes the picture’s sharpness.
Adjusts picture detail of VIDEO display.
COLOR Changes the color density.
TINT Changes the picture’s tint. Adjust for natural colored skin, background, etc.

Adjusting the computer image

Only the contrast and brightness can be adjusted when a computer signal is connected.

Restoring the factory default settings

Select “**RESET**” under the “**PICTURE MODE**” settings.

Setting the picture mode according to the brightness of the room

There are four picture modes that can be used effectively according to the environment in which you are viewing the display.

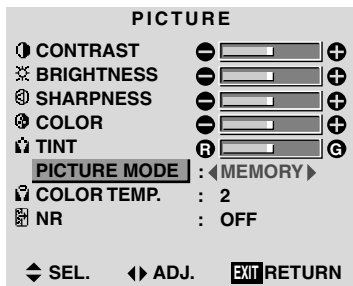
Example: Setting the "THEATER" mode

Press the **PROCEED** button on the remote control to display the **MAIN MENU** on the screen, then...

1. Use the ▲ and ▼ buttons to select "PICTURE", then press the **PROCEED** button.

The "PICTURE" screen appears.

2. Use the ▲ and ▼ buttons to select "PICTURE MODE".

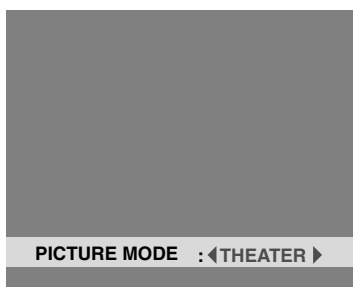


3. To set to "THEATER" ...

Use the ◀ and ▶ buttons to select "THEATER".

The mode switches as follows when the ◀ and ▶ buttons are pressed:

→ MEMORY ↔ THEATER ↔ NORMAL ↔ RESET ←



* If neither the ◀ or ▶ button is pressed within 5 seconds, the current selection is set and the previous screen reappears.

4. Once the adjustment is completed ...

Press the **EXIT** button to return to the main menu. To delete the main menu, press the **EXIT** button once more.

Information

Types of picture modes

MEMORY The last picture adjustments are stored here.

THEATER Set this mode when watching video in a dark room.

This mode provides darker, finer pictures, like the screen in movie theaters.

CONTRAST = 80% for RESET mode
BRIGHTNESS = 95% for RESET mode

NORMAL Set this mode when watching video in a bright room.

This mode provides dynamic pictures with distinct differences between light and dark sections.

CONTRAST = 96% for RESET mode

RESET Use this to reset the picture to the factory default settings.

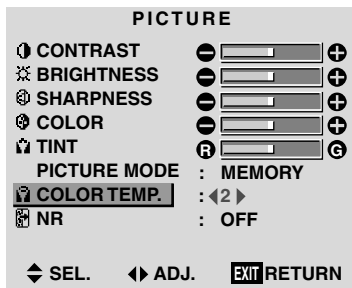
Setting the color temperature

Use this procedure to set color tone produced by the plasma display.

Example: Setting "1"

Press the *PROCEED* button on the remote control to display the *MAIN MENU* on the screen, then...

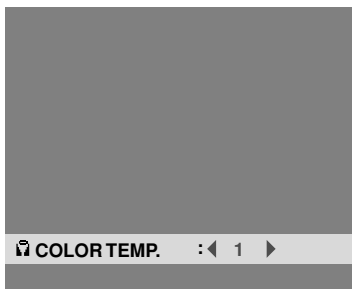
1. Use the ▲ and ▼ buttons to select "PICTURE", then press the *PROCEED* button.
The "PICTURE" screen appears.
2. Use the ▲ and ▼ buttons to select "COLOR TEMP.":



3. Use the ◀ and ▶ buttons to select "1".
The mode switches as follows when the ◀ and ▶ buttons are pressed:

→ 1 ↔ 2 ↔ 3 ↔ PRO ←

* See page 22 to set "PRO".



* If neither the ◀ or ▶ button is pressed within 5 seconds, the current selection is set and the previous screen reappears.

4. Once the setting is completed...

Press the *EXIT* button to return to the main menu.

To delete the main menu, press the *EXIT* button once more.

Information

■ Setting the color temperature

- 1 High (bluer)
- 2 Middle (Standard)
- 3 Low (redder)

■ Restoring the factory default settings

Select "RESET" under the function menu. Note that this also restores other settings to the factory defaults.

Adjusting the color to the desired quality

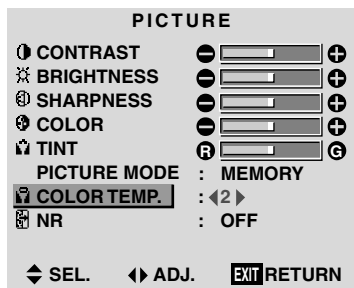
Use this procedure to adjust the white balance for bright pictures and dark pictures to achieve the desired color quality.

Example: Adjusting the “WHITE BALANCE”

Press the *PROCEED* button on the remote control to display the *MAIN MENU* on the screen, then...

1. Use the ▲ and ▼ buttons to select “PICTURE”, then press the *PROCEED* button.
The “PICTURE” screen appears.

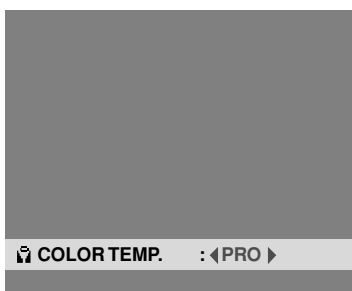
2. Use the ▲ and ▼ buttons to select “COLOR TEMP.”.



3. Use the ◀ and ▶ buttons to select “PRO”.

The mode switches as follows when the ◀ and ▶ buttons are pressed:

→ 1 ↔ 2 ↔ 3 ↔ PRO ←

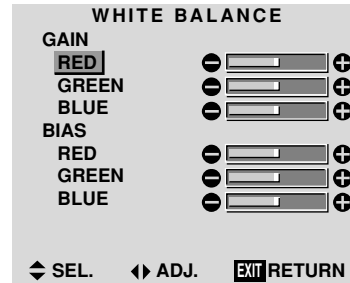


- * If neither the ◀ or ▶ button is pressed within 5 seconds, the current selection is set and the previous screen reappears.

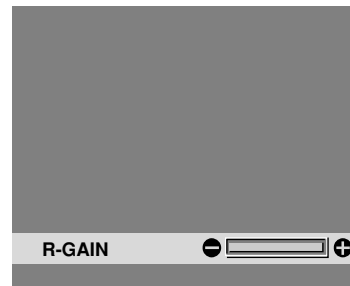
4. Press the *PROCEED* button.

The “WHITE BALANCE” screen appears.

5. Use the ▲ and ▼ buttons to select “RED-GAIN”.



6. Adjust the white balance using the ◀ and ▶ buttons.



- * If neither the ◀ or ▶ button is pressed within 5 seconds, the current setting is set and the previous screen reappears.

7. Once the adjustment is completed...

Press the *EXIT* button to return to the main menu. To delete the main menu, press the *EXIT* button once more.

Information

■ Adjusting the white balance

RGB-GAIN White balance adjustment for signal level

RGB-BIAS White balance adjustment for black level

■ Restoring the factory default settings

Select “RESET” under the function menu. Note that this also restores other settings to the factory defaults.

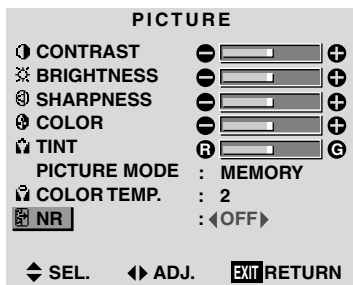
Reducing noise in the picture

Use these settings if the picture has noise due to poor reception or when playing video tapes on which the picture quality is poor.

Example: Setting "NR-3"

Press the *PROCEED* button on the remote control to display the *MAIN MENU* on the screen, then...

1. Use the ▲ and ▼ buttons to select "PICTURE", then press the *PROCEED* button.
The "PICTURE" screen appears.
2. Use the ▲ and ▼ buttons to select "NR".



3. Use the ◀ and ▶ buttons to select "NR-3".
The mode switches as follows when the ◀ and ▶ buttons are pressed:

→ OFF ↔ NR-1 ↔ NR-2 ↔ NR-3 ←



* If neither the ◀ or ▶ button is pressed within 5 seconds, the current selection is set and the previous screen reappears.

4. *Once the setting is completed ...*

Press the *EXIT* button to return to the main menu.

To delete the main menu, press the *EXIT* button once more.

Information

■ NR

* "NR" stands for Noise Reduction.

* This function reduces noise in the picture.

■ Types of noise reduction

There are three types of noise reduction. Each has a different level of noise reduction.

The effect becomes stronger as the number increases (in the order NR-1 → NR-2 → NR-3).

OFF Turns the noise reduction function off.

Sound Settings Menu

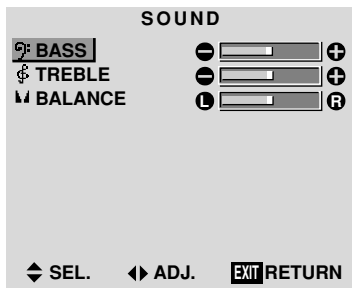
Adjusting the treble, bass and left/right balance

The treble, bass and left/right balance can be adjusted to suit your tastes.

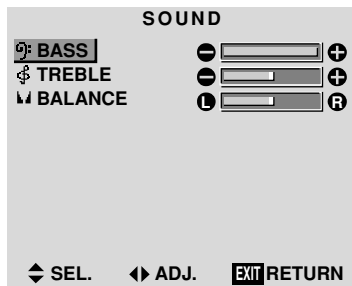
Example: Adjusting the bass

Press the **PROCEED** button on the remote control to display the **MAIN MENU** on the screen, then...

1. Use the ▲ and ▼ buttons to select “**SOUND**”, then press the **PROCEED** button.
The “**SOUND**” screen appears.
2. *To adjust the bass ...*
Use the ▲ and ▼ buttons to select “**BASS**”.



3. Adjust the bass using the ◀ and ▶ buttons.



* If neither the ◀ or ▶ button is pressed within 5 seconds, the current selection is set and the previous screen reappears.

To continue adjusting the sound ...

Repeat from step 2.

4. *Once the adjustment is completed ...*

Press the **EXIT** button to return to the main menu. To delete the main menu, press the **EXIT** button once more.

Note : If “**CAN NOT ADJUST**” appears...
Set “**AUDIO INPUT**” on the **OPTION** menu correctly.

Information

■ Sound settings menu

BASS Changes the level of low frequency sound.

TREBLE Changes the level of high frequency sound.

BALANCE Changes the balance of the left and right channels.

■ Restoring the factory default settings

Select “**RESET**” under the function menu. Note that this also restores other settings to the factory defaults.

Screen Settings Menu

Adjusting the Position, Size, Fine Picture, Picture Adj

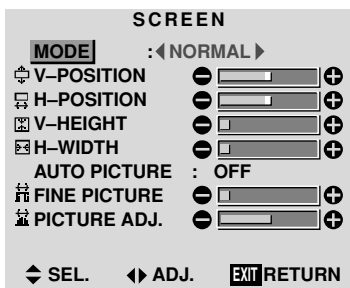
The position of the image can be adjusted and flickering of the image can be corrected.

Example: Adjusting the vertical position in the normal mode

Press the *PROCEED* button on the remote control to display the *MAIN MENU* on the screen, then...

1. Use the ▲ and ▼ buttons to select “SCREEN”, then press the *PROCEED* button. The “SCREEN” menu appears.

Default settings (when RGB/PC is selected)



* The settings on the SCREEN menu are not preset at the factory.

To select a mode ...

Use the ◀ and ▶ buttons to select a mode.

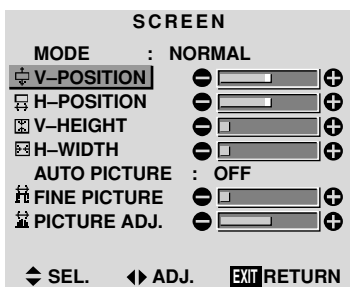
The mode switches as follows when the ◀ and ▶ buttons are pressed:

→ NORMAL ↔ FULL ←

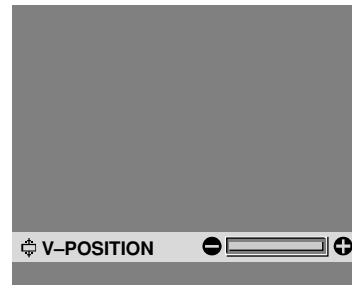
* The mode can also be switched by pressing the “WIDE” button on the remote control.

2. To adjust the vertical position ...

Use the ▲ and ▼ buttons to select “V-POSITION”.



3. Adjust using the ◀ and ▶ buttons.



* If neither the ◀ or ▶ button is pressed within 5 seconds, the current setting is set and the previous screen reappears.

To continue making other computer image adjustments ...

Repeat from step 2.

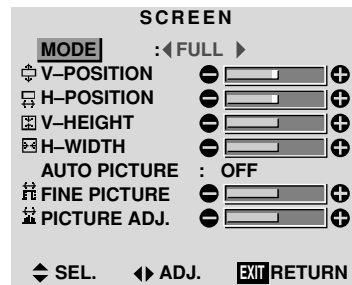
4. Once all adjustments are completed ...

Press the *EXIT* button to return to the main menu.

To delete the main menu, press the *EXIT* button once more.

Information

■ When “AUTO PICTURE” is “OFF”



When Auto Picture is off, the Fine Picture and the Picture ADJ items are displayed so that you can adjust them.

Information

■ Adjusting the Auto Picture

ON The Picture ADJ and Fine Picture adjustments are made automatically.

OFF The Picture ADJ and Fine Picture adjustments are made manually.

■ Adjusting the position of the image

V-POSITION ... Adjusts the vertical position of the image.

H-POSITION ... Adjusts the horizontal position of the image.

V-HEIGHT Adjusts the vertical size of the image. (Except for STADIUM mode)

H-WIDTH Adjusts the horizontal size of the image. (Except for STADIUM mode)

FINE PICTURE* .. Adjusts for flickering.

PICTURE ADJ* Adjusts for striped patterns on the image.

* The Picture ADJ and Fine Picture features are available only when the "Auto Picture" is off.

* The AUTO PICTURE, FINE PICTURE and PICTURE ADJ. are not available for VIDEO and HD/DVD source.

■ Restoring the factory default settings

Select "RESET" under the function menu. Note that this also restores other settings to the factory defaults except for Auto Picture.

Function Settings Menu

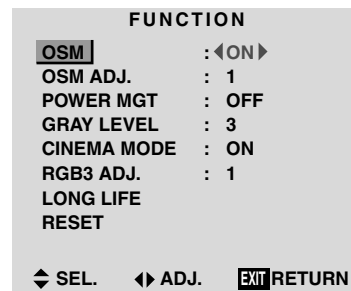
Setting the on-screen menu

When using the monitor for presentations, etc., the monitor can be set so that the input source, screen mode, etc., do not appear.

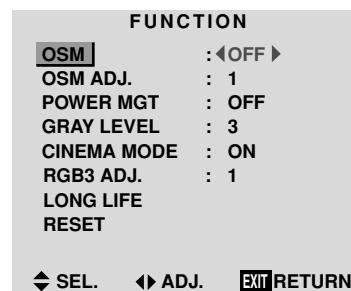
Example: Turning the on-screen menu mode off

Press the *PROCEED* button on the remote control to display the *MAIN MENU* on the screen, then...

1. Use the ▲ and ▼ buttons to select "FUNCTION", then press the *PROCEED* button. The "FUNCTION" screen appears.
2. Use the ▲ and ▼ buttons to select "OSM".



3. To turn the on-screen menu mode off... Use the ◀ and ▶ buttons to select "OFF". The mode switches as follows each time the ◀ or ▶ button is pressed:
ON ↔ OFF



4. Once the setting is completed ... Press the *EXIT* button to return to the main menu. To delete the main menu, press the *EXIT* button once more.

Information

■ OSM modes

ON The on-screen menu appears.

OFF The on-screen menu does not appear.

■ Restoring the factory default settings

Select "RESET" under the function menu. Note that this also restores other settings to the factory defaults.

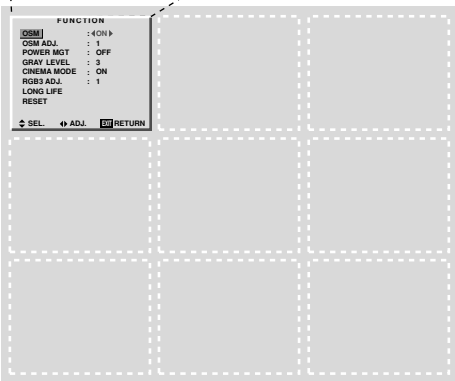
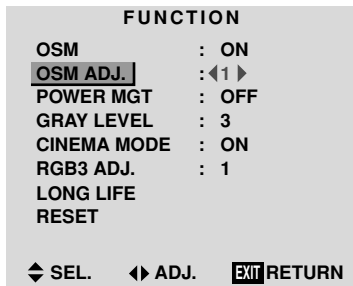
Adjusting the position of the menu display

Use these operations to adjust the position of the menus that appear on the screen.

Example: Adjusting the position of the menu display

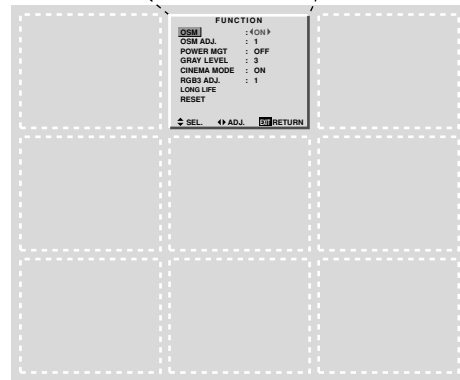
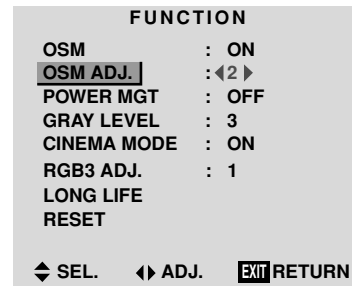
Press the *PROCEED* button on the remote control to display the *MAIN MENU* on the screen, then...

1. Use the ▲ and ▼ buttons to select “FUNCTION”, then press the *PROCEED* button. The “FUNCTION” menu appears.
2. Use the ▲ and ▼ buttons to select “OSM ADJ.”



3. To adjust the position...

Adjust using the ◀ and ▶ buttons.



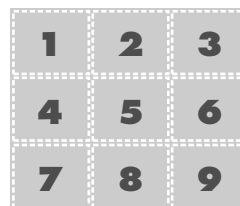
4. Once all adjustments are completed ...

Press the *EXIT* button to return to the main menu.

To delete the main menu, press the *EXIT* button once more.

Information

■ Adjusting the position of the menu display



The position can be set between 1 and 9.

■ Restoring the factory default settings

Select “RESET” under the function menu. Note that this also restores other settings to the factory defaults.

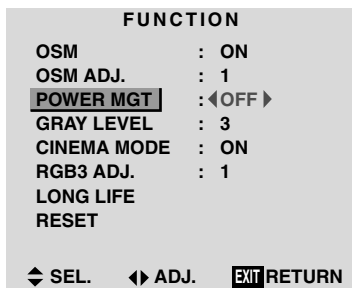
Setting the power management for computer images

This energy-saving (power management) function automatically reduces the monitor's power consumption if no operation is performed for a certain amount of time.

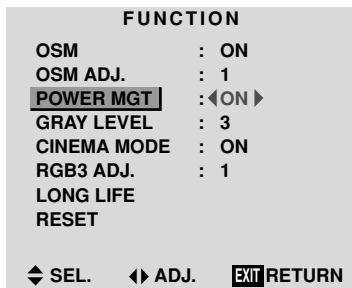
Example: Turning the power management function on

Press the **PROCEED** button on the remote control to display the **MAIN MENU** on the screen, then...

1. Use the ▲ and ▼ buttons to select "FUNCTION", then press the **PROCEED** button.
The "FUNCTION" screen appears.
2. Use the ▲ and ▼ buttons to select "POWER MGT".



3. To turn the power management function on ...
Use the ◀ and ▶ buttons to select "ON".
The mode switches as follows each time the ◀ or ▶ button is pressed:
ON ↔ OFF



4. Once the setting is completed ...
Press the **EXIT** button to return to the main menu.
To delete the main menu, press the **EXIT** button once more.

Information

■ Power management function

- * The power management function automatically reduces the monitor's power consumption if the computer's keyboard or mouse is not operated for a certain amount of time. This function can be used when using the monitor with a computer conforming to the VESA DPMS format.
- * If the computer's power is not turned on or if the computer and selector tuner are not properly connected, the system is set to the off state.
- * For instructions on using the computer's power management function, refer to the computer's operating instructions.

■ Power management settings

- ON In this mode the power management function is turned on.
- OFF In this mode the power management function is turned off.

■ Power management function and POWER/STANDBY indicator

The POWER/STANDBY indicator indicates the status of the power management function. See page 29 for indicator status and description.

■ Restoring the factory default settings

Select "RESET" under the function menu. Note that this also restores other settings to the factory defaults.

POWER/STANDBY indicator

Power management mode	POWER/STANDBY indicator	Power management operating status	Description	Turning the picture back on
On	Green	Not activated.	Horizontal and vertical synchronizing signals are present from the computer.	Picture already on.
Standby	Orange	Activated.	No horizontal synchronizing signals are sent from the computer.	Operate the keyboard or mouse. The picture reappears immediately.
Suspend	Red	Activated.	No vertical synchronizing signals are sent from the computer.	Operate the keyboard or mouse. The picture reappears, but more time is required than from the standby mode.
Off	Red	Activated.	No horizontal or vertical synchronizing signals are sent from the computer.	Operate the keyboard or mouse. The picture reappears, but more time is required than from the standby mode or suspend mode.

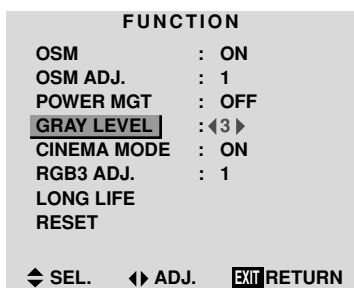
Setting the gray level for the sides of the screen

Use this procedure to set the gray level for the parts on the screen on which nothing is displayed when the screen is set to the 4:3 size.

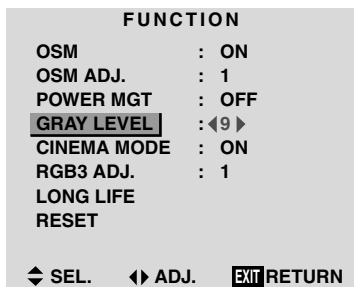
Example: Adjusting the “GRAY LEVEL”

Press the **PROCEED** button on the remote control to display the **MAIN MENU** on the screen, then...

1. Use the ▲ and ▼ buttons to select “FUNCTION”, then press the **PROCEED** button.
The “FUNCTION” screen appears.
2. Use the ▲ and ▼ buttons to select “GRAY LEVEL”.



3. To adjust the “GRAY LEVEL”...
Use the ◀ and ▶ buttons to adjust the GRAY LEVEL.



4. Once the setting is completed ...
Press the **EXIT** button to return to the main menu.
To delete the main menu, press the **EXIT** button once more.

Information

■ GRAY LEVEL

This adjusts the brightness of the black (the gray level) for the sides of the screen.
The standard is 0 (black). The level can be adjusted from 0 to 15. The factory setting is 3 (dark gray).

■ Restoring the factory default settings

Select “RESET” under the function menu. Note that this also restores other settings to the factory defaults.

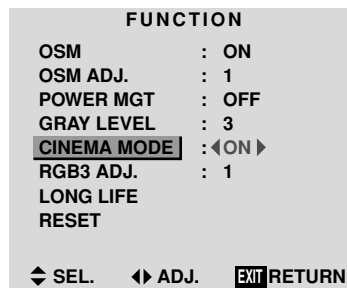
Setting the picture to suit the movie

The film image is automatically discriminated and projected in an image mode suited to the picture.
[NTSC, 480I (60Hz), 1035I (60Hz), 1080I (60Hz) only]

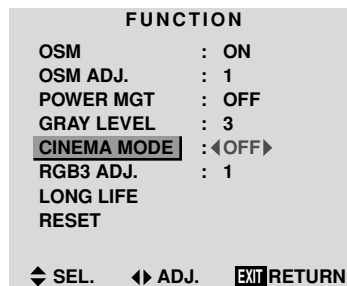
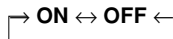
Example: Setting the “CINEMA MODE” to “OFF”

Press the **PROCEED** button on the remote control to display the **MAIN MENU** on the screen, then...

1. Use the ▲ and ▼ buttons to select “FUNCTION”, then press the **PROCEED** button.
The “FUNCTION” screen appears.
2. Use the ▲ and ▼ buttons to select “CINEMA MODE”.



3. To set the **CINEMA MODE** to “OFF” ...
Use the ◀ and ▶ buttons to select “OFF”.
The mode switches as follows each time the ◀ or ▶ button is pressed:



4. Once the setting is completed ...
Press the **EXIT** button to return to the main menu.
To delete the main menu, press the **EXIT** button once more.

Information

■ CINEMA MODE

ON Automatic discrimination of the image and projection in cinema mode.
OFF Cinema mode does not function.

■ Restoring the factory default settings

Select “RESET” under the function menu. Note that this also restores other settings to the factory defaults.

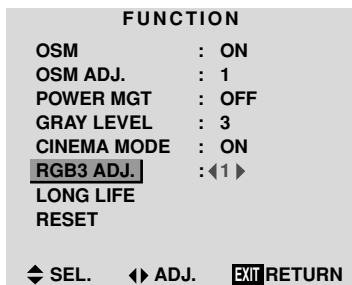
Setting RGB3 ADJ.

When the picture input from the RGB3 input terminal is distorted, select the most appropriate setting from among “1”, “2”, and “3”.

Example: Setting “2”

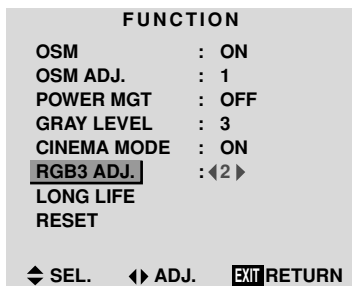
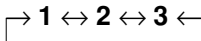
Press the **PROCEED** button on the remote control to display **MAIN MENU** on the screen, then...

1. Use the ▲ and ▼ buttons to select “FUNCTION”, then press the **PROCEED** button.
The “FUNCTION” screen appears.
2. Use the ▲ and ▼ buttons to select “RGB3 ADJ.”.



3. To select “2”...

Use the ◀ and ▶ buttons to select “2”.
The mode switches as follows each time the ◀ or ▶ button is pressed:



4. Once the setting is completed...

Press the **EXIT** button to return to the main menu.
To delete the main menu, press the **EXIT** button once more.

Information

■ When you adjust the RGB3 ADJ.

The position of the menu display will change. In such a case, be sure to adjust the position.

■ Restoring the factory default settings

Select “RESET” under the function menu. Note that this also restores other settings to the factory defaults.

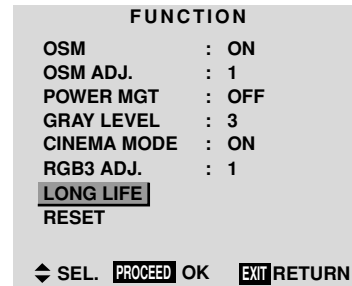
Reducing burn-in of the screen

The brightness of the screen, the position of the picture, and positive/negative mode are adjusted to reduce burn-in of the screen.

Example: Setting “PLE” to “LOCK”

Press the **PROCEED** button on the remote control to display the **MAIN MENU** on the screen, then proceed as follows.

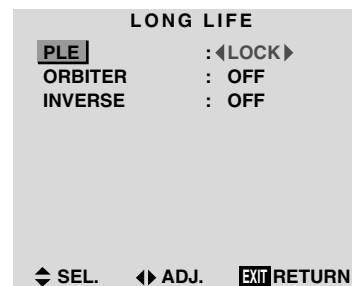
1. Use the ▲ and ▼ buttons to select “FUNCTION”, then press the **PROCEED** button.
The “FUNCTION” screen appears.
2. Use the ▲ and ▼ buttons to select “LONG LIFE”, then press the **PROCEED** button.



The “LONG LIFE” screen appears.

3. Use the ▲ and ▼ buttons to select “PLE”, then use the ◀ and ▶ buttons to select “LOCK”.
The mode switch changes as follows each time the ◀ or ▶ button is pressed:

AUTO ↔ LOCK



4. Once the setting is completed...

Press the **EXIT** button to return to the **FUNCTION** menu.

To exit the main menu, press the **EXIT** button twice.

Information

■ PLE

AUTO The brightness of the screen is adjusted automatically to suit the picture quality.

LOCK The brightness level is set to minimum.

■ ORBITER

ON The picture moves around the screen intermittently.

OFF Orbiter mode does not function.

■ INVERSE

ON The picture is displayed alternately between positive image and negative image.

OFF Inverse mode does not function.

WT The entire screen turns white.

■ Restoring the factory default settings

Select "RESET" from the function menu. Note that this also restores other settings to the factory defaults.

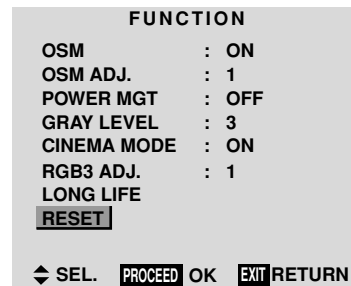
Resetting to the default values

Use these operations to restore all the picture adjustments, audio settings, to the factory default values.

Refer to page 18 for items to be reset.

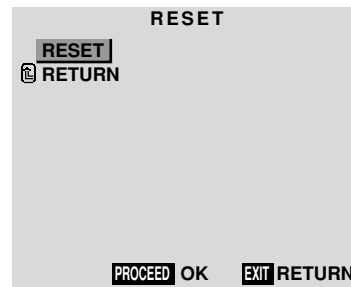
Press the PROCEED button on the remote control to display the MAIN MENU on the screen, then...

1. Use the ▲ and ▼ buttons to select "FUNCTION", then press the PROCEED button.
The "FUNCTION" screen appears.
2. Use the ▲ and ▼ buttons to select "RESET", then press the PROCEED button.



The "RESET" screen appears.

3. Use the ▲ and ▼ buttons to select "RESET", then press the PROCEED button.



When the "SETTING NOW" screen disappears, the screen will be restored to the previous "RESET" mode, then all the settings are restored to the default values.

4. *Once the setting is completed ...*

Press the EXIT button.

To delete the main menu, press the EXIT button once more.

Option Settings Menu

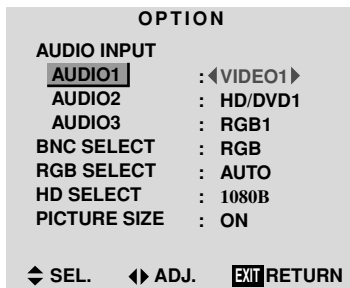
Setting the allocation of the audio connectors

Setting the AUDIO 1, 2, and 3 connectors to the desired input.

Example: Setting "AUDIO 1" to "VIDEO 2"

Press the **PROCEED** button on the remote control to display the **MAIN MENU** on the screen, then...

1. Use the **▲** and **▼** buttons to select "OPTION", then press the **PROCEED** button.
The "OPTION" screen appears.
2. Use the **▲** and **▼** buttons to select "AUDIO 1".



3. To set the **AUDIO1** to "VIDEO2"...
Use the **◀** and **▶** buttons to select "VIDEO2".
The mode switches as follows each time the **◀** or **▶** button is pressed:

→ VIDEO1 ↔ VIDEO2 ↔ VIDEO3 ↔ HD/DVD1 ↔ RGB/PC1 ↔ RGB/PC2 ↔ RGB/PC3 ←



4. Once the setting is completed...
Press the **EXIT** button to return to the main menu.
To delete the main menu, press the **EXIT** button once more.

Information

■ AUDIO INPUT

A single audio input cannot be selected as the audio channel for more than one input terminal.

■ Restoring the factory default settings

Select "RESET" under the function menu. Note that this also restores other settings to the factory defaults.

Setting the BNC connectors

Select whether to set the input of the 5 BNC connectors to RGB or component.

Example: Set the BNC SELECT mode to "COMP."

Press the **PROCEED** button on the remote control to display the **MAIN MENU** on the screen, then...

1. Use the **▲** and **▼** buttons to select "OPTION", then press the **PROCEED** button.
The "OPTION" screen appears.
2. Use the **▲** and **▼** buttons to select "BNC SELECT".



3. To set the **BNC SELECT** mode to "COMP."...
Use the **◀** and **▶** buttons to select "COMP."
The mode switches as follows each time the **◀** or **▶** button is pressed:
RGB ↔ COMP.



4. Once the setting is completed...
Press the **EXIT** button to return to the main menu.
To delete the main menu, press the **EXIT** button once more.

Information

■ BNC SELECT

RGB Uses the 5BNC terminal for RGB input.

COMP. Use the 3BNC terminal for component input.

■ Restoring the factory default settings

Select "RESET" under the function menu. Note that this also restores other settings to the factory defaults.

Setting a computer image to the correct RGB select screen

With the computer image, select the RGB Select mode for a moving image such as (video) mode, wide mode or digital broadcast.

Example: Setting the "RGB SELECT" mode to "MOTION"

Press the *PROCEED* button on the remote control to display the *MAIN MENU* on the screen, then...

1. Use the ▲ and ▼ buttons to select "OPTION", then press the *PROCEED* button.
The "OPTION" screen appears.
2. Use the ▲ and ▼ buttons to select "RGB SELECT".



3. To set the RGB select mode to "MOTION" ...
Use the ◀ and ▶ buttons to select "MOTION".
The mode switches as follows each time the ◀ or ▶ button is pressed:

→ AUTO ↔ STILL ↔ MOTION ↔ WIDE1 ↔ WIDE2 ↔ DTV ←



4. Once the setting is completed ...
Press the *EXIT* button to return to the main menu.
To delete the main menu, press the *EXIT* button once more.

Information

■ RGB SELECT modes

One of these 6 modes must be selected in order to display the following signals correctly.

AUTO Select the suitable mode for the specifications of input signals as listed in the table “Computer input signals supported by this system” on page 47.

STILL To display VESA standard signals. (Use this mode for a still image from a computer.)

MOTION The video signal (from a scan converter) will be converted to RGB signals to make the picture more easily viewable. (Use this mode for a motion image from a computer.)

WIDE1 When an 852 dot × 480 line signal with a horizontal frequency of 31.7kHz is input, the image may be compressed horizontally. To prevent this, set RGB SELECT to WIDE1.

WIDE2 When an 848 dot × 480 line signal with a horizontal frequency of 31.0 kHz is input, the image may be compressed horizontally. To prevent this, set RGB SELECT to WIDE2.

DTV Set this mode when watching digital broadcasting (480P).

See page 47 for the details of the above settings.

■ Restoring the factory default settings

Select “RESET” under the function menu. Note that this also restores other settings to the factory defaults.

Setting high definition images to the suitable screen size

Use this procedure to set whether the number of vertical lines of the input high definition image is 1035 or 1080.

Example: Setting the “1080B” mode to “1035I”

Press the **PROCEED** button on the remote control to display the **MAIN MENU** on the screen, then...

1. Use the **▲** and **▼** buttons to select “OPTION”, then press the **PROCEED** button.
The “OPTION” screen appears.
2. Use the **▲** and **▼** buttons to select “HD SELECT”.



3. To set the **HD SELECT** mode to “1035I” ...
Use the **◀** and **▶** buttons to select “1035I”.
The mode switches as follows each time the **◀** or **▶** button is pressed:

→1080A ↔ 1080B ↔ 1035I ←



4. Once the setting is completed ...
Press the **EXIT** button to return to the main menu.
To delete the main menu, press the **EXIT** button once more.

Information

■ HD SELECT modes

These 3 modes are not displayed in correct image automatically.

1080A Special Digital broadcasts (for example : DTC100)

1080B Standard digital broadcasts

1035I Japanese “High Vision” signal format

Setting the picture size for RGB input signals

Use this procedure to switch the setting to “ON” or “OFF”.

Example: Setting the “ON” mode to “OFF”

Press the *PROCEED* button on the remote control to display the *MAIN MENU* on the screen, then...

1. Use the ▲ and ▼ buttons to select “OPTION”, then press the *PROCEED* button.
The “OPTION” screen appears.
2. Use the ▲ and ▼ buttons to select “PICTURE SIZE”.



3. To set *PICTURE SIZE* mode to “OFF”...
Use the ◀ and ▶ buttons to select “OFF”.
The mode switches as follows when the ◀ or ▶ buttons are pressed:
ON ↔ OFF



4. Once the setting is completed ...
Press the *EXIT* button to return to the main menu.
To delete the main menu, press the *EXIT* button once more.

Information

■ PICTURE SIZE

ON For RGB Input: “NORMAL” and “FULL” can be selected for Wide-Screen switching.

OFF For RGB Input: “TRUE” and “FULL” can be selected for Wide-Screen switching.

■ Restoring the factory default settings

Select “RESET” under the function menu. Note that this also restores other settings to the factory defaults.

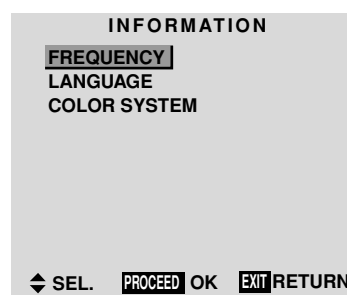
Information Menu

Checking the frequencies, polarities of input signals, and resolution

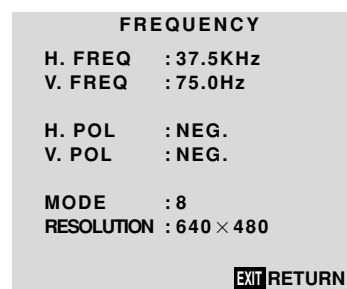
Use this function to check the frequencies and polarities of the signals currently being input from a computer, etc.

Press the *PROCEED* button on the remote control to display the *MAIN MENU* on the screen, then...

1. Use the ▲ and ▼ buttons to select “INFORMATION”, then press the *PROCEED* button.
The “INFORMATION” screen appears.
2. Use the ▲ and ▼ buttons to select “FREQUENCY”, then press the *PROCEED* button.



3. The frequency is displayed.



* Press the *EXIT* button to return to the previous screen.

4. Once you have checked the frequency ...
Press the *EXIT* button to return to the main menu.
To delete the main menu, press the *EXIT* button once more.

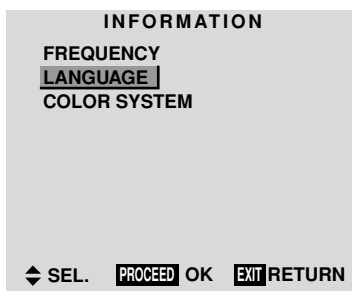
Setting the language for the menus

The menu display can be set to one of seven languages: Japanese, English, German, French, Swedish, Italian or Spanish.

Example: Setting the menu display to “DEUTSCH”

Press the **PROCEED** button on the remote control to display the **MAIN MENU** on the screen, then...

1. Use the ▲ and ▼ buttons to select “**INFORMATION**”, then press the **PROCEED** button. The “**INFORMATION**” screen appears.
2. Use the ▲ and ▼ buttons to select “**LANGUAGE**”, then press the **PROCEED** button.



The “**LANGUAGE**” screen appears.

3. To select “**DEUTSCH**” ...
Use the ◀ and ▶ buttons to select “**DEUTSCH**”.
The mode switches as follows when the ◀ and ▶ buttons are pressed:

→ ENGLISH ↔ DEUTSCH ↔ FRANÇAIS ←
→ 日本語 ↔ SVENSKA ↔ ITALIANO ↔ ESPAÑOL ←



4. Press the **PROCEED** button.
The display language is switched to Deutsch.
5. Once the setting is completed ...
Press the **EXIT** button to return to the main menu.
To delete the main menu, press the **EXIT** button once more.

Information

■ Language settings

ENGLISH English
 DEUTSCH German
 FRANÇAIS French
 ESPAÑOL Spanish
 ITALIANO Italian
 SVENSKA Swedish
 日本語 Japanese

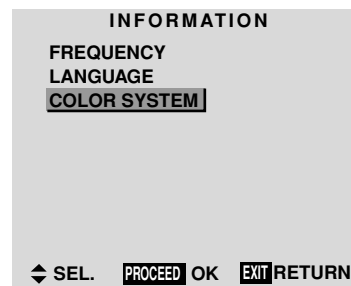
Setting the video signal format

Use these operations to set the video signal format.

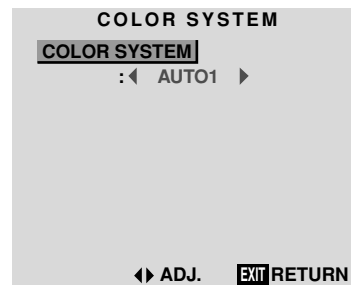
Example: Setting the video signal format to “3.58 NTSC”

Press the **PROCEED** button on the remote control to display the **MAIN MENU** on the screen, then...

1. Use the ▲ and ▼ buttons to select “**INFORMATION**”, then press the **PROCEED** button.
The “**INFORMATION**” screen appears.
2. Use the ▲ and ▼ buttons to select “**COLOR SYSTEM**”, then press the **PROCEED** button.



The “**COLOR SYSTEM**” screen appears.



3. To select “3.58 NTSC” ...
Use the ◀ and ▶ buttons to select “3.58 NTSC”.
The mode switches as follows when the ◀ and ▶ buttons are pressed:

→ AUTO1 ↔ AUTO2 ↔ 3.58NTSC ↔ 4.43NTSC ←
→ SECAM ↔ PAL-M ↔ PAL-N ↔ PAL60 ↔ PAL ←



4. *Once the setting is completed ...*

Press the EXIT button to return to the main menu.
To delete the main menu, press the EXIT button once more.

The color system is set to “3.58 NTSC”.

Information

■ **Video signal formats**

Different countries use different formats for video signals. Set to the format used in your current country.

AUTO1/2 The video signals are automatically detected and the format is set accordingly.

AUTO1: 3.58NTSC, 4.43NTSC, PAL, SECAM, PAL60

AUTO2: PAL-M, PAL-N, 3.58NTSC

PAL (B, G) This is the standard format used mainly in the United Kingdom and Germany.

SECAM..... This is the standard format used mainly in France and Russia.

4.43 NTSC,

PAL60 This format is used for videos in countries using PAL and SECAM video signals.

3.58 NTSC This is the standard format used mainly in Japan and the United States.

PAL-M This is the standard format used mainly in Brazil.

PAL-N This is the standard format used mainly in Argentina.

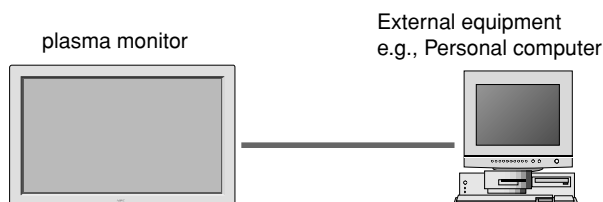
External Control

Application

These specifications cover the communications control of the plasma monitor by external equipment.

Connections

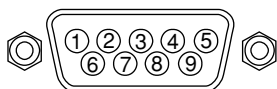
Connections are made as described below.



- 1) Connector on the plasma monitor side: EXTERNAL CONTROL connector.

Type of connector: D-Sub 9-pin male

No.	Pin Name
1	No Connection
2	RXD (Receive data)
3	TXD (Transmit data)
4	DTR (DTE side ready)
5	GND
6	DSR (DCE side ready)
7	RTS (Ready to send)
8	CTS (Clear to send)
9	No Connection



- 2) Connector on the external equipment side: Serial port (RS-232C) connector.

See the specifications of the equipment that is to be connected for the type of connector and the pin assignment.

- 3) Wiring

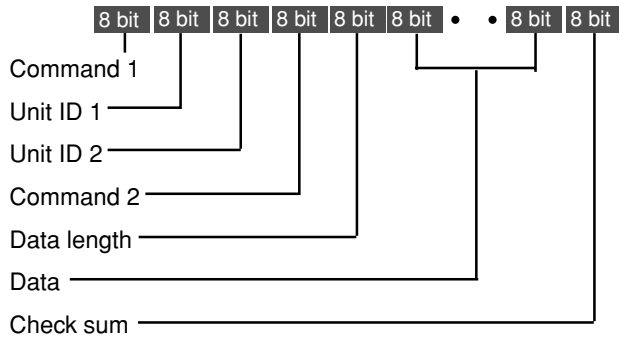
Use a crossed (reverse) cable.

Wire the cable so that each pair of data lines cross between the two devices. These data line pairs are RXD (Receive data) and TXD (Transmit data), DTR (DTE side ready) and DSR (DCE side ready), and RTS (Ready to send) and CTS (Clear to send).

Communication Parameters

- | | |
|--------------------------|--------------|
| (1) Communication system | Asynchronous |
| (2) Interface | RS-232C |
| (3) Baud rate | 9600 bps |
| (4) Data length | 8 bits |
| (5) Parity | Odd |
| (6) Stop bit | 1 bit |
| (7) Communication code | Hex |

Communication Format



Command 1

Command 1, along with command 2, is a number used to distinguish each command.

In the case of ACK, when the lower order 4 bits is FH (as in 3FH and 7FH), this indicates that the commands and data of the supported equipment have been received. When the lower order 4 bits is BH (as in 3BH and 7BH), this indicates that unsupported commands and data have been received.

Unit ID 1 and Unit ID 2

Unit ID 1 and unit ID 2 are numbers used to identify the equipment that is to be connected.

60H is used for the plasma monitor and 80H is used for external control equipment such as a personal computer.

- 1) Unit ID 1: Indicates the equipment sending the signal
- 2) Unit ID 2: Indicates the equipment receiving the signal

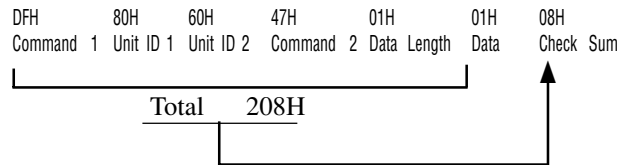
Command 2

Command 2, along with command 1, is a number used to distinguish each command.

Check Sum (CKS), Error Processing, and ACK

- 1) The check sum described below and RS-232C odd parity are used together for a check of the received data. The check sum is the lower order 8 bits of one frame of sent or received data comprising the sum total of Command 1, Unit ID 1 and 2, Command 2, Data Length, and Data.

Check Sum Example



2) Error Processing

- When the communication interval is vacant for more than 4 ms, thereafter a received Command 1 will be recognized. If, at this time, meaningful data cannot be recognized, that data will not be recognized (as valid data).
- An ACK will not be returned unless the receive data error, the check sum error, and the receive data are all taken in.

Command Reference List

	CMD1	CMD2	LEN
01. Power ON	9FH	4EH	00H
02. Power OFF	9FH	4FH	00H
03. Input Switch Change	DFH	47H	01H
04. VOLUME Gain Data	DFH	7FH	03H
05. SCREEN MODE Select	DFH	51H	01H
06. AUDIO Mute On	9FH	3EH	00H
07. AUDIO Mute Off	9FH	3FH	00H
08. OSM Select	DFH	58H	01H
09. Color Gain Data	DFH	7FH	03H
10. TINT Gain Data	DFH	7FH	03H
11. SHARPNESS Gain Data	DFH	7FH	03H
12. CONTRAST Gain Data	DFH	7FH	03H
13. BRIGHT Gain Data	DFH	7FH	03H
14. Input MODE Request	1FH	41H	00H
15. RESET	1FH	54H	00H
16. COLOR TEMP SELECT	DFH	00H	01H
17. RED Gain Data	DFH	7FH	04H
18. GREEN Gain Data	DFH	7FH	04H
19. BLUE Gain Data	DFH	7FH	04H
20. Multi Screen Select	DFH	07H	01H
21. VIDEO ADJ Request	1FH	45H	00H
22. Audio Select Set	DFH	70H	02H
23. Audio Select Request	1FH	6FH	00H
24. LONG LIFE Set	DFH	6BH	03H
25. Failure Mode Request	1FH	3FH	00H

01. Power ON

Function

The external control equipment switches on the power of the plasma monitor.

Transmission Data

9FH	80H	60H	4EH	00H	CKS
-----	-----	-----	-----	-----	-----

ACK

The plasma monitor returns the following ACK when the power is switched on.

3FH	60H	80H	4EH	00H	CKS
-----	-----	-----	-----	-----	-----

NOTE: Do not set the Power ON or Power OFF command continuously.

02. Power OFF

Function

The external control equipment switches off the power of the plasma monitor.

Transmission Data

9FH	80H	60H	4FH	00H	CKS
-----	-----	-----	-----	-----	-----

ACK

The plasma monitor returns the following ACK when the power is switched off.

3FH	60H	80H	4FH	00H	CKS
-----	-----	-----	-----	-----	-----

NOTE: Do not set the Power ON or Power OFF command continuously.

03. Input Switch Change

Function

The external control equipment switches the input of the plasma monitor.

Transmission Data

DFH	80H	60H	47H	01H	DATA00	CKS
DATA00	: Input Select				01H: Video1	
					02H: Video2	
					03H: Video3	
					05H: HD (HD1 or DTV or DTV1)	
					06H: HD2 (DTV2)	
					07H: RGB1/PC1	
					08H: RGB2/PC2	
					0CH: RGB3/PC3	

ACK

The plasma monitor returns the following ACK when the input is switched.

3FH	60H	80H	47H	00H	CKS
-----	-----	-----	-----	-----	-----

04. VOLUME Gain Data

Function

The external control equipment changes the VOLUME gain data of the plasma monitor.

Transmission Data

DFH	80H	60H	7FH	03H	DATA00	DATA01	DATA02	CKS
DATA00	USER SOUND Gain Flag				05H			
DATA01	VOLUME Gain Flag				01H			
DATA02	VOLUME Gain				00H: Step 0			
					0AH: Step 10 (Default)			
					2AH: Step 42			

ACK

7FH	60H	80H	7FH	02H	DATA00	DATA01	CKS
-----	-----	-----	-----	-----	--------	--------	-----

DATA00	USER SOUND Gain Flag				05H		
--------	----------------------	--	--	--	-----	--	--

DATA01	VOLUME Gain Flag				01H		
--------	------------------	--	--	--	-----	--	--

05. SCREEN MODE Select

Function

The external control equipment switches the screen mode of the plasma monitor.

Transmission Data

DFH	80H	60H	51H	01H	DATA00	CKS
-----	-----	-----	-----	-----	--------	-----

DATA00	02H : STADIUM					
	03H : ZOOM					
	04H : NORMAL					
	05H : FULL					
	06H : TRUE (REAL)					

ACK

7FH	60H	80H	51H	01H	DATA00	CKS
-----	-----	-----	-----	-----	--------	-----

DATA00	02H : STADIUM					
	03H : ZOOM					
	04H : NORMAL					
	05H : FULL					
	06H : TRUE (REAL)					

06. AUDIO Mute On

Function

The external control equipment switches on AUDIO Mute of the plasma monitor.

Transmission Data

9FH	80H	60H	3EH	00H	CKS
-----	-----	-----	-----	-----	-----

ACK

3FH	60H	80H	3EH	00H	CKS
-----	-----	-----	-----	-----	-----

07. AUDIO Mute Off

Function

The external control equipment switches off AUDIO Mute of the plasma monitor.

Transmission Data

9FH	80H	60H	3FH	00H	CKS
-----	-----	-----	-----	-----	-----

ACK

3FH	60H	80H	3FH	00H	CKS
-----	-----	-----	-----	-----	-----

08. OSM Select

Function

The external control equipment switches on or off the on-screen menu (OSM) of the plasma monitor.

Transmission Data

DFH	80H	60H	58H	01H	DATA00	CKS
-----	-----	-----	-----	-----	--------	-----

DATA00 01H : On-Screen menu On

02H : On-Screen menu Off

ACK

7FH	60H	80H	58H	01H	DATA00	CKS
-----	-----	-----	-----	-----	--------	-----

DATA00 01H : On-Screen menu On

02H : On-Screen menu Off

On-Screen menu On/Off is equivalent to the On-screen menu On/Off function of the convenient function settings.

*Operation is as described in the table below.

09. COLOR Gain Data

Function

The external control equipment changes the COLOR gain data of the plasma monitor.

Transmission Data

DFH	80H	60H	7FH	03H	DATA00	DATA01	DATA02	CKS
-----	-----	-----	-----	-----	--------	--------	--------	-----

DATA00: USER PICTURE Gain Flag

01H

DATA01: COLOR Gain Flag

04H

DATA02: COLOR Gain

E0H: -32

* COLOR Gain is from -22 (EAH) to

+22 (16H) only during video.

FFH: -01

00H: 0

01H: +01

|

20H: +32

ACK

7FH	60H	80H	7FH	02H	DATA00	DATA01	CKS
-----	-----	-----	-----	-----	--------	--------	-----

DATA00: USER PICTURE Gain Flag

01H

DATA01: COLOR Gain Flag

04H

10. TINT Gain Data

Function

The external control equipment changes the TINT gain data of the plasma monitor.

Transmission Data

DFH	80H	60H	7FH	03H	DATA00	DATA01	DATA02	CKS
-----	-----	-----	-----	-----	--------	--------	--------	-----

DATA00: USER PICTURE Gain Flag

01H

DATA01: TINT Gain Flag

05H

DATA02: TINT Gain

E0H: -32

* TINT Gain is from -22 (EAH) to

+22 (16H) only during video.

FFH: -01

00H: 0

01H: +01

|

20H: +32

ACK

7FH	60H	80H	7FH	02H	DATA00	DATA01	CKS
-----	-----	-----	-----	-----	--------	--------	-----

DATA00: USER PICTURE Gain Flag

01H

DATA01: TINT Gain Flag

05H

Operation	On-Screen Menu (OSM)			
	Display of items and adjustments on the menu		Volume display, input display, and screen size display	
	When screen menu is ON	When screen menu is OFF	When screen menu is ON	When screen menu is OFF
Remote control operation	Yes	Yes	Yes	No
Personal computer control operation	No	No	Yes	No

11. SHARPNESS Gain Data

Function

The external control equipment changes the SHARPNESS gain data of the plasma monitor.

Transmission Data

DFH	80H	60H	7FH	03H	DATA00	DATA01	DATA02	CKS
DATA00:	USER PICTURE	Gain Flag			01H			
DATA01:	SHARPNESS	Gain Flag			06H			
DATA02:	SHARPNESS	Gain			0FH: -16			
					FFH: -01			
					00H: 0			
					01H: +01			
					10H: +16			

ACK

7FH	60H	80H	7FH	02H	DATA00	DATA01	CKS
DATA00:	USER PICTURE	Gain Flag			01H		
DATA01:	SHARPNESS	Gain Flag			06H		

12. CONTRAST Gain Data

Function

The external control equipment changes the CONTRAST gain data of the plasma monitor.

Transmission Data

DFH	80H	60H	7FH	03H	DATA00	DATA01	DATA02	CKS
DATA00:	USER PICTURE	Gain Flag			01H			
DATA01:	CONTRAST	Gain Flag			07H			
DATA02:	CONTRAST	Gain			CCH: -52			
					FFH: -01			
					00H: 0			
					01H: +01			
					14H: +20			

ACK

7FH	60H	80H	7FH	02H	DATA00	DATA01	CKS
DATA00:	USER PICTURE	Gain Flag			01H		
DATA01:	CONTRAST	Gain Flag			07H		

13. BRIGHT Gain Data

Function

The external control equipment changes the BRIGHT gain data of the plasma monitor.

Transmission Data

DFH	80H	60H	7FH	03H	DATA00	DATA01	DATA02	CKS
DATA00:	USER PICTURE	Gain Flag			01H			
DATA01:	BRIGHT	Gain Flag			08H			
DATA02:	BRIGHT	Gain			E0H: -32			
					FFH: -01			
					00H: 0			
					01H: +01			
					20H: +32			

ACK

7FH	60H	80H	7FH	02H	DATA00	DATA01	CKS
DATA00:	USER PICTURE	Gain Flag			01H		
DATA01:	BRIGHT	Gain Flag			08H		

14. Input MODE Request

Function

The display returns the current input information by the external control equipment's request.

Transmission Data

1FH	80H	60H	41H	00H	CKS
-----	-----	-----	-----	-----	-----

ACK

7FH	60H	80H	41H	01H	DATA00	CKS
DATA00:	Input Select					
	01H: Video1				02H: Video2	
	03H: Video3				04H: HD (HD1 or DTV or DTV1)	
	05H: RGB1/PC1				06H: RGB2/PC2	
	0AH: DVD (DVD1)				0CH: HD2 (DTV2)	
	0DH: DVD2				0EH: RGB3/PC3	

15. RESET

Function

The external control equipment resets the user adjustment of the plasma monitor.

Transmission Data

1FH	80H	60H	54H	00H	CKS
-----	-----	-----	-----	-----	-----

ACK

3FH	60H	80H	54H	00H	CKS
-----	-----	-----	-----	-----	-----

16. COLOR TEMP SELECT

Function

The external control equipment changes the COLOR TEMP of the plasma monitor.

Transmission Data

DFH	80H	60H	00H	01H	DATA00	CKS
DATA00:						
					00H: 1	
					01H: 2	
					02H: 3	
					03H: PRO	

ACK

7FH	60H	80H	00H	01H	DATA00	CKS
DATA00:						
					00H: 1	
					01H: 2	
					02H: 3	
					03H: PRO	

NOTE: Set so that at the selection of 1, 2, or 3 of COLOR TEMP change of the following R/G/B GAIN data cannot be accepted.

17. RED Gain Data

Function

The external control equipment changes the RED Gain Data of the plasma monitor.

Transmission Data

DFH	80H	60H	7FH	04H	DATA00 to DATA03	CKS
DATA00:	USER PICTURE	Gain Flag			01H	
DATA01:	RED Gain Flag				01H	
DATA02:	RED Gain 1 (Bias)				D8H: -40	
					FFH: -1	
					00H: 0	
					IEH: +30	
DATA03:	RED Gain 2 (Drive)				D8H: -40	
					FFH: -1	
					00H: 0	
					IEH: +30	

ACK

7FH	60H	80H	7FH	02H	DATA00	DATA01	CKS
DATA00:	USER PICTURE	Gain Flag			01H		
DATA01:	RED Gain Flag				01H		

18. GREEN Gain Data

Function

The external control equipment changes the GREEN Gain Data of the plasma monitor.

Transmission Data

DFH	80H	60H	7FH	04H	DATA00 to DATA03	CKS
DATA00:	USER PICTURE	Gain Flag			01H	
DATA01:	GREEN Gain Flag				02H	
DATA02:	GREEN Gain 1 (Bias)				D8H: -40	
					FFH: -1	
					00H: 0	
					IEH: +30	
DATA03:	GREEN Gain2 (Drive)				D8H: -40	
					FFH: -1	
					00H: 0	
					IEH: +30	

ACK

7FH	60H	80H	7FH	02H	DATA00	DATA01	CKS
DATA00:	USER PICTURE	Gain Flag			01H		
DATA01:	GREEN Gain Flag				02H		

19. BLUE Gain Data

Function

The external control equipment changes the BLUE Gain Data of the plasma monitor.

Transmission Data

DFH	80H	60H	7FH	04H	DATA00 to DATA03	CKS
DATA00:	USER PICTURE	Gain Flag			01H	
DATA01:	BLUE Gain Flag				03H	
DATA02:	BLUE Gain1(Bias)				D8H: -40	
					FFH: -1	
					00H: 0	
					IEH: +30	
DATA03:	BLUE Gain2(Drive)				D8H: -40	
					FFH: -1	
					00H: 0	
					IEH: +30	

ACK

7FH	60H	80H	7FH	02H	DATA00	DATA01	CKS
DATA00:	USER PICTURE	Gain Flag			01H		
DATA01:	BLUE Gain Flag				03H		

20. Multi Screen Select

Function

The external control equipment selects single screen mode or multi screen mode of the display.

Transmission Data

DFH	80H	60H	07H	01H	DATA00	CKS
DATA00:	Multi Screen					
	00: Single screen					
	01: Side by side 1 (Left screen bigger)					
	02: Side by side 2 (Left screen smaller)					
	03: Picture in Picture sub screen L					
	04: Picture in Picture sub screen R					

ACK

The display returns the following ACK.

7FH	60H	80H	07H	01H	DATA00	CKS
DATA00:	Multi Screen					
	00: Single screen					
	01: Side by side 1 (Left screen bigger)					
	02: Side by side 2 (Left screen smaller)					
	03: Picture in Picture sub screen L					
	04: Picture in Picture sub screen R					

When other commands (except POWER OFF) are sent while the screens are switching with this command, the other command will be returned as "Not Available" until screen switching is finished.

21. VIDEO ADJ Request

Function

The display returns the video adjustments information by the external control equipment's request.

Transmission Data

1FH 80H 60H 45H 00H CKS

ACK

7FH 60H 80H 45H 0CH DATA00 to DATA0B CKS

DATA00: RED Gain(Bias)

D8H: -40

FFH: -1
00H: 0

IEH: +30

DATA01: GREEN Gain(Bias)

D8H: -40

FFH: -1
00H: 0

IEH: +30

DATA02: BLUE Gain(Bias)

D8H: -40

FFH: -1
00H: 0

IEH: +30

DATA03: COLOR Gain

E0H: -32

FFH: -01
00H: 0

01H: +01

20H: +32

* COLOR Gain is from -22 (EAH) to +22 (16H) only during video.

DATA04: TINT Gain

E0H: -32

FFH: -01
00H: 0

01H: +01

20H: +32

* TINT Gain is from -22 (EAH) to +22 (16H) only during video.

DATA05: SHARPNESS Gain

F0H: -16

FFH: -01
00H: 0

01H: +01

10H: +16

DATA06: CONTRAST Gain

CCH: -52

FFH: -01
00H: 0

01H: +01

14H: +20

DATA07: BRIGHT Gain

E0H: -32

FFH: -01
00H: 0

01H: +01

20H: +32

DATA08: RED Gain(Drive)

D8H: -40

FFH: -1
00H: 0

IEH: +30

DATA09: GREEN Gain(Drive)

D8H: -40

FFH: -1
00H: 0

IEH: +30

DATA0A: BLUE Gain(Drive)

D8H: -40

FFH: -1
00H: 0

IEH: +30

DATA0B: COLOR TEMP

00H: 1

01H: 2

02H: 3

03H: PRO

22. Audio Select Set

Function

The external control equipment sets combinations of audio and video inputs for the plasma monitor.

Transmission Data

DFH	80H	60H	70H	02H	DATA00	DATA01	CKS
DATA00:	AUDIO INPUT						
	01H:	AUDIO 1					
	02H:	AUDIO 2					
	03H:	AUDIO 3					
DATA01:	VISUAL INPUT						
	01H:	Video 1					
	02H:	Video 2					
	03H:	Video 3					
	05H:	HD (HD1 or DTV or DTV1)					
	06H:	HD2 (DTV2)					
	07H:	RGB 1/ PC 1					
	08H:	RGB 2/ PC 2					
	0CH:	RGB 3/ PC 3					

ACK

The plasma monitor returns the following ACK when the input is switched.

3FH	60H	80H	70H	00H	CKS
-----	-----	-----	-----	-----	-----

* The plasma monitor returns “Not Available” when selecting the video input same as the one set at one of the AUDIO 01 to 3.

Example:

The plasma monitor returns “Not Available” when selecting the VIDEO1 for AUDIO2 or VIDEO3 after VIDEO1 has been set to AUDIO1.

23. Audio Select Request

Function

The external control equipment inquires the current combinations of audio and video inputs for the plasma monitor.

Transmission Data

1FH	80H	60H	6FH	00H	CKS
-----	-----	-----	-----	-----	-----

ACK

The plasma monitor returns the following ACK:

7FH	60H	80H	6FH	03H	DATA00	DATA01	DATA02	CKS
-----	-----	-----	-----	-----	--------	--------	--------	-----

DATA00:	AUDIO 1							
	01H - 0CH:	VISUAL INPUT DATA						
DATA01:	AUDIO 2							
	01H - 0CH:	VISUAL INPUT DATA						
DATA02:	AUDIO 3							
	01H - 0CH:	VISUAL INPUT DATA						
		VISUAL INPUT DATA						
	01H:	Video 1						
	02H:	Video 2						
	03H:	Video 3						
	05H:	HD (HD1 or DTV or DTV 1)						
	06H:	HD2 (DTV2)						
	07H:	RGB 1/PC 1						
	08H:	RGB 2/PC 2						
	0CH:	RGB 3/PC 3						

24. LONG LIFE Set

Function

The external control equipment sets the PLE, ORBITER, and INVERSE (inverse of image brightness) of the plasma monitor.

Transmission Data

DFH	80H	60H	6BH	03H	DATA00	DATA01	DATA02	CKS
DATA00 :	PLE							
	01H:	AUTO						
	02H:	LOCK						
DATA01 :	INVERSE							
	01H:	ON						
	02H:	OFF						
	03H:	WHITE						
DATA02 :	ORBITER (PICTURE SHIFT)							
	01H:	ON						
	02H:	OFF						

ACK

The plasma monitor returns the following ACK when setting the PLE, ORBITER, and INVERSE (inverse of image brightness):

3FH	60H	80H	6BH	00H	CKS
-----	-----	-----	-----	-----	-----

25. Failure Mode Request

Function

The external control equipment inquires the detection of failures of the plasma monitor.

Transmission Data

1FH	80H	60H	3FH	00H	CKS
-----	-----	-----	-----	-----	-----

ACK

The plasma monitor returns the following ACK:

7FH	60H	80H	3FH	02H	DATA00	DATA01	CKS
-----	-----	-----	-----	-----	--------	--------	-----

DATA00:	FAILURE MODE 1							
	Bit 0 :	PDP MODULE						
		0: Abnormal						
		1: Normal						
	Bit 1 :	1: fixed (backup)						
	Bit 2 :	TEMPERATURE						
		0: Abnormal						
		1: Normal						
	Bit 3 :	FAN						
		0: Abnormal						
		1: Normal						
	Bit 4 :	1: fixed (backup)						
	Bit 5 :	1: fixed (backup)						
	Bit 6 :	1: fixed (backup)						
	Bit 7 :	1: fixed (backup)						
DATA01:	FAILURE MODE 2							
	Bit 0-7 :	1: fixed (backup)						

Table of Signals Supported

Supported resolution

- When the screen mode is NORMAL, each signal is converted to a 1024 dots × 768 lines signal. (Except for *2,3,4)
- When the screen mode is TRUE, the picture is displayed in the original resolution.
- When the screen mode is FULL, each signal is converted to a 1364 dots × 768 lines signal. (Except for *3)

Computer input signals supported by this system

Model Signal Type	Dots × lines	Vertical frequency (Hz)	Horizontal frequency (kHz)	Sync Polarity		Presence		Screen mode			RGB select*5	DVI
				Horizontal	Vertical	Horizontal	Vertical	NORMAL (4:3)	TRUE	FULL (16:9)		
	640 × 400	70.1	31.5	NEG	NEG	YES	YES	YES*2	YES	YES	--	NO
*IBM PC/AT compatible computers	640 × 480	59.9	31.5	NEG	NEG	YES	YES	YES	YES	YES	STILL	YES
		72.8	37.9	NEG	NEG	YES	YES	YES	YES	YES	--	YES
		75.0	37.5	NEG	NEG	YES	YES	YES	YES	YES	STILL	YES
		85.0	43.3	NEG	NEG	YES	YES	YES	YES	YES	--	YES
		100.4	51.1	NEG	NEG	YES	YES	YES	YES	YES	--	YES
		120.4	61.3	NEG	NEG	YES	YES	YES	YES	YES	--	YES
	848 × 480	60.0	31.0	POS	POS	YES	YES	--	YES	YES	WIDE2	YES
	852 × 480*1	60.0	31.7	NEG	NEG	YES	YES	--	YES	YES	WIDE1	YES
	800 × 600	56.3	35.2	POS	POS	YES	YES	YES	YES	YES	STILL	YES
		60.3	37.9	POS	POS	YES	YES	YES	YES	YES	STILL	YES
		72.2	48.1	POS	POS	YES	YES	YES	YES	YES	--	YES
		75.0	46.9	POS	POS	YES	YES	YES	YES	YES	--	YES
		85.1	53.7	POS	POS	YES	YES	YES	YES	YES	--	YES
		99.8	63.0	POS	POS	YES	YES	YES	YES	YES	--	YES
		120.0	75.7	POS	POS	YES	YES	YES	YES	YES	--	YES
	1024 × 768	60.0	48.4	NEG	NEG	YES	YES	YES*3	--	YES	STILL	YES
		70.1	56.5	NEG	NEG	YES	YES	YES*3	--	YES	--	YES
		75.0	60.0	POS	POS	YES	YES	YES*3	--	YES	STILL	YES
		85.0	68.7	POS	POS	YES	YES	YES*3	--	YES	--	YES
		100.6	80.5	NEG	NEG	YES	YES	YES*3	--	YES	--	NO
	1152 × 864	75.0	67.5	POS	POS	YES	YES	YES	--	YES	STILL	YES
	1280 × 768	56.2	45.1	POS	POS	YES	YES	--	--	YES	WIDE1	NO
	1360 × 765	60.0	47.7	POS	POS	YES	YES	--	--	YES*3	WIDE1	NO
1360 × 768	60.0	47.7	POS	POS	YES	YES	--	--	YES*3	WIDE1	NO	
1376 × 768	59.9	48.3	NEG	POS	YES	YES	--	--	YES	WIDE2	YES	
1280 × 1024	60.0	64.0	POS	POS	YES	YES	YES*4	--	YES	STILL	YES	
	75.0	80.0	POS	POS	YES	YES	YES*4	--	YES	--	NO	
	85.0	91.1	POS	POS	YES	YES	YES*4	--	YES	--	NO	
1600 × 1200	60.0	75.0	POS	POS	YES	YES	YES	--	YES	--	NO	
	65.0	81.3	POS	POS	YES	YES	YES	--	YES	--	NO	
	70.0	87.5	POS	POS	YES	YES	YES	--	YES	--	NO	
	75.0	93.8	POS	POS	YES	YES	YES	--	YES	--	NO	
*Apple Macintosh*6	640 × 480	66.7	35.0	Sync on G	Sync on G	--	--	YES	YES	YES	--	NO
	832 × 624	74.6	49.7	Sync on G	Sync on G	--	--	YES	YES	YES	--	NO
	1024 × 768	74.9	60.2	Sync on G	Sync on G	--	--	YES*3	--	YES	--	NO
	1152 × 870	75.1	68.7	Sync on G	Sync on G	--	--	YES	--	YES	--	NO
Work Station (EWS4800)	1280 × 1024	60.0	64.6	NEG	NEG	YES	YES	YES*4	--	YES	--	NO
		71.2	75.1	NEG	NEG	YES	YES	YES*4	--	YES	--	NO
Work Station (HP)	1280 × 1024	72.0	78.1	--	--	--	--	YES*4	--	YES	--	YES
Work Station (SUN)	1152 × 900	66.0	61.8	C Sync	C Sync	--	--	YES	--	YES	--	NO
		76.0	71.7	C Sync	C Sync	--	--	YES	--	YES	--	NO
	1280 × 1024	76.1	81.1	C Sync	C Sync	--	--	YES*4	--	YES	--	NO
Work Station (SGI)	1024 × 768	60.0	49.7	--	--	--	--	YES*3	--	YES	--	NO
	1280 × 1024	60.0	63.9	--	--	--	--	YES*4	--	YES	--	YES
IDC-3000G												YES
PAL625P NTSC525P	768 × 576	50.0	31.4	NEG	NEG	YES	YES	YES*7	--	YES*7	--	NO
	640 × 480	59.9	31.5	NEG	NEG	YES	YES	YES*7	--	YES*7	MOTION	NO

-
- *1 Only when using a graphic accelerator board that is capable of displaying 852×480 .
 - *2 This signal is converted to a $1228 \text{ dots} \times 768 \text{ lines}$ signal.
 - *3 The picture is displayed in the original resolution.
 - *4 The aspect ratio is 5:4. This signal is converted to a $960 \text{ dot} \times 768 \text{ line}$ signal.
 - *5 Normally the RGB select mode suite for the input signals is set automatically. If the picture is not displayed properly, set the RGB mode prepared for the input signals listed in the table above.
 - *6 To connect the monitor to Macintosh computer, use the supplied monitor adapter (D-Sub 15-pin) to your computer's video port. If your computer has a mini D-Sub 15-pin connector, you may have to use the supplied RGB cable.
 - *7 Other screen modes (ZOOM and STADIUM) are available as well.

NOTE:

- *While the input signals comply with the resolution listed in the table above, you may have to adjust the position and size of the picture or the fine picture because of errors in synchronization of your computer.*
 - *When a $1280 \text{ dot} \times 1024 \text{ line}$ signal or $1600 \text{ dot} \times 1200 \text{ line}$ signal is input to the monitor, the picture will be compressed.*
 - *This monitor has a resolution of $1365 \text{ dot} \times 768 \text{ line}$. It is recommended that the input signal should be XGA, wide XGA, or equivalent.*
 - *With digital input some signals are not accepted.*
 - *The sync may be disturbed when a nonstandard signal other than the aforementioned is input.*
 - *If you are connecting a composite sync signal, use the HD terminal.*
-

- * "IBM PC/AT" and "VGA" are registered trademarks of IBM, Inc. of the United States.
- * "Apple Macintosh" is a registered trademark of Apple Computer, Inc. of the United States.

Troubleshooting

If the picture quality is poor or there is some other problem, check the adjustments, operations, etc., before requesting service.

Symptom	Checks	Remedy
Picture is disturbed. Sound is noisy. Remote control operates erroneously.	<ul style="list-style-type: none"> Is a connected component set directly in front or at the side of the display? 	<ul style="list-style-type: none"> Leave some space between the display and the connected components.
The remote control does not work.	<ul style="list-style-type: none"> Are the remote control's batteries worn out? 	<ul style="list-style-type: none"> Replace both batteries with new ones.
Monitor's power does not turn on when the remote control's power button is pressed.	<ul style="list-style-type: none"> Is the monitor's power cord plugged into a power outlet? 	<ul style="list-style-type: none"> Plug the monitor's power cord into a power outlet.
	<ul style="list-style-type: none"> Are all the monitor's indicators off? 	<ul style="list-style-type: none"> Press the power button on the monitor to turn on the power.
	<ul style="list-style-type: none"> Are the remote control's batteries worn out? 	<ul style="list-style-type: none"> Replace both batteries with new ones.
Monitor does not operate when the remote control's buttons are pressed.	<ul style="list-style-type: none"> Is the remote control pointed at the monitor, or is there an obstacle between the remote control and the monitor? 	<ul style="list-style-type: none"> Point the remote control at the monitor's remote control sensor when pressing buttons, or remove the obstacle.
	<ul style="list-style-type: none"> Is direct sunlight or strong artificial light shining on the monitor's remote control sensor? 	<ul style="list-style-type: none"> Eliminate the light by closing curtains, pointing the light in a different direction, etc.
	<ul style="list-style-type: none"> Are the remote control's batteries worn out? 	<ul style="list-style-type: none"> Replace both batteries with new ones.
	<ul style="list-style-type: none"> The remote cable is plugged into the REMOTE IN terminal (Wired). 	<ul style="list-style-type: none"> Unplug the remote cable from the monitor.
	<ul style="list-style-type: none"> The front panel buttons of the main unit do not function. 	<ul style="list-style-type: none"> The front panel buttons do not function during Control Lock.
No sound or picture is produced.	<ul style="list-style-type: none"> Is the monitor's power cord plugged into a power outlet? 	<ul style="list-style-type: none"> Plug the monitor's power cord into a power outlet.
Picture appears but no sound is produced.	<ul style="list-style-type: none"> Is the volume set at the minimum? 	<ul style="list-style-type: none"> Increase the volume.
	<ul style="list-style-type: none"> Is the mute mode set? 	<ul style="list-style-type: none"> Press the remote control's MUTE button.
	<ul style="list-style-type: none"> Are the speakers properly connected? 	<ul style="list-style-type: none"> Connect the speakers properly.
	<ul style="list-style-type: none"> Is AUDIO INPUT set correctly? 	<ul style="list-style-type: none"> Set AUDIO INPUT on the OPTION menu correctly.
Poor picture with VIDEO signal input.	<ul style="list-style-type: none"> Improper control setting. Local interference. Cable interconnections. Input impedance is not correct level. 	<ul style="list-style-type: none"> Adjust picture control as needed. Try another location for the monitor. Be sure all connections are secure.
Poor picture with RGB signal input.	<ul style="list-style-type: none"> Improper control setting. Incorrect 15 PIN connector pin connections. 	<ul style="list-style-type: none"> Adjust picture controls as needed. Check pin assignments and connections.
Tint is poor or colors are weak.	<ul style="list-style-type: none"> Are the tint and colors properly adjusted? 	<ul style="list-style-type: none"> Adjust the tint and color (under "PICTURE").
Nothing appears on screen.	<ul style="list-style-type: none"> Is the computer's power turned on? 	<ul style="list-style-type: none"> Turn on the computer's power.
	<ul style="list-style-type: none"> Is a source connected? 	<ul style="list-style-type: none"> Connect source to the monitor.
	<ul style="list-style-type: none"> Is the power management function in the standby or off mode? 	<ul style="list-style-type: none"> Operate the computer (move the mouse, etc.).
Part of picture is cut off or picture is not centered.	<ul style="list-style-type: none"> Is the position adjustment appropriate? 	<ul style="list-style-type: none"> Adjust the "SCREEN" properly.
Image is too large or too small.	<ul style="list-style-type: none"> Is the screen size adjustment appropriate? 	<ul style="list-style-type: none"> Press the "WIDE" button on the remote control and adjust properly.
Picture is unstable.	<ul style="list-style-type: none"> Is the computer's resolution setting appropriate? 	<ul style="list-style-type: none"> Set to the proper resolution.
POWER/STANDBY indicator is lighted in orange or red.	<ul style="list-style-type: none"> Horizontal and / or vertical sync signal is not present when the Intelligent Power Manager control is on. 	<ul style="list-style-type: none"> Check the input signal.
POWER/STANDBY indicator is blinking in red.	<ul style="list-style-type: none"> The temperature inside the main unit has become too high and has activated the protector. 	<ul style="list-style-type: none"> Promptly switch off the power of the main unit and wait until the internal temperature drops. See*1.
POWER/STANDBY indicator is blinking in green.	<p style="text-align: center;">_____</p>	<ul style="list-style-type: none"> Promptly switch off the power of the main unit. See *2.

*1 Overheat protector

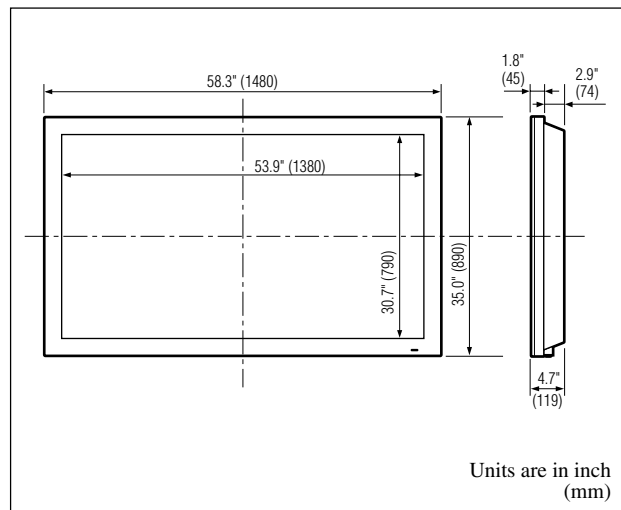
If the monitor becomes too hot, the overheat protector will be activated and the monitor will be turned off. If this happens., turn off the power to the monitor and unplug the power cord. If the room where the monitor is installed is particularly hot, move the monitor to a cooler location and wait for the monitor to cool for 60 minutes. If the problem persists, contact your NEC dealer for service.

*2 In the following case, power off the monitor immediately and contact your dealer or authorized NEC Service Center.

The monitor turns off 5 seconds after powering on and then the POWER/STANDBY indicator blinks. It indicates that the power supply circuit or, one or more fans have been damaged.

Specifications

Product Name	PlasmaSync™ 61MP1 Plasma Monitor
Product Code	PX- 61XM1A
Screen Size	53.2"(H) × 29.9"(V) inches 1351(H) × 760(V) mm diagonal 61"
Aspect Ratio	16 : 9
Resolution	1365(H) × 768(V) pixels
Pixel Pitch	0.039"(H) × 0.039"(V) inches 0.987(H) × 0.987(V) mm
Color Reproduction	256 levels, 16,770,000 colors
Signals	
Synchronization Range	Horizontal : 15.5 to 93.8 kHz (automatic : step scan) Vertical : 50.0 to 120 Hz (automatic : step scan)
Input Signals	RGB, NTSC (3.58/4.43), PAL (B,G,M,N), PAL60, SECAM, HD* ¹ , DVD* ¹ , DTV* ¹
Input Terminals	
RGB	
Visual 1 (Analog)	mini D-sub 15-pin × 1
Visual 2 (Analog)	BNC (R, G, B, H/CS, V) × 1* ³
Visual 3 (Digital)	DVI-I 29-pin × 1* ² (Not compatible with analog input)
Video	
Visual 1	RCA-pin × 1
Visual 2	BNC × 1
Visual 3	S ₂ -Video: DIN 4-pin × 1
DVD/HD/DTV	
Visual	RCA-pin (Y, PB[CB], PR[CR])* ¹
Audio	Stereo RCA × 3(selectable)
External Control	D-sub 9-pin × 1(RS-232C)
Sound output	7W+7W at 6 ohm
Power Supply	AC120V 50/60Hz
Current Rating	6.9A (maximum)
Power Consumption	660W (typical)
Dimensions	58.3 (W) × 35.0 (H) × 4.7 (D) inches 1480 (W) × 890 (H) × 119(D) mm
Weight	134.5 lbs / 61.0 kg
Environmental Considerations	
Operating Temperature	0°C to 35°C / 32°F to 95°F
Humidity	20 to 80%
Storage Temperature	-10°C to 50°C / 14°F to 122°F
Humidity	10 to 90%
Front Panel User Controls	Power on/off, Input source select, Volume up/down, OSM control
Remote Control Functions	Power on/off, Input source select, OSM control, Volume up/down, Cursor (UP, DOWN, LEFT, RIGHT), Pointer, Zoom up/down, Off timer, Wireless/ Wired remote control
OSM Functions	Picture (Contrast / Brightness / Sharpness/ Color / Tint / Picture mode / Color temperature/ Noise reductions), Sound (Bass / Treble/ Balance), Screen (V-Position / H-Position/ V-Height / H-Width / Auto Picture / Fine picture/ Picture adjustment), Function (OSM/ OSM adjustment/ Power management/ Gray level/ Cinema mode/ RGB3 Adjustment, Long Life (PLE, Orbiter, Inverse, White)/ Reset)/ Option (Audio input/ BNC select/ RGBselect/ HD select/ Picture Size), Information (Frequency / Language / Color system)



The features and specifications may be subject to change without notice.

*¹ HD/DVD/DTV input signals supported on this system

480P (60 Hz)	480I (60 Hz)
525P (60 Hz)	525I (60 Hz)
625P (50 Hz)	625I (50 Hz)
720P (60 Hz)	1035I (60 Hz)
	1080I (60 Hz)

*² It doesn't cope with copy protection.

*³ A change of DVD2/HD2 can be performed with RGB2.

Other Features	3D motion adaptive Scan Converter (with 2-3 pull down Converter), Digital Zoom function (100-300% Selectable) (Tentative), Self Diagnosis, Anti Image Burn, Color Temperature Select, Control Lock, Power management, Plug and play (DDC1, DDC2b, RGB3: DDC2b only), Multi screen operation
Accessories	Remote control with two AAA batteries, Remote cable, RGB cable (Mini D-Sub 15-pin to Mini D-Sub 15-pin connector), Power cord, User's Manual, Safety metal fittings, Ferrite cores, Bands
Regulations	UL Approved (UL 1950/ CSA 950) DOC Canada requirements Meets FCC class A requirements

NEC

NEC Technologies, Inc.
1250 N. Arlington Heights Road, Suite 500
Itasca, Illinois 60143-1248

Printed on recycled paper

Printed in Japan
7S800261



PlasmaSync 61MP1
PlasmaSync Plasma Monitor

User's Manual

Bedienungshandbuch

Manuel de l'utilisateur

Manual del Usuario

Manuale d'uso

Bruksanvisning

User's Manual

Bedienungshandbuch

Manuel de l'utilisateur

Manual del Usuario

Manuale d'uso


Bruksanvisning

Important Information


Precautions

Please read this manual carefully before using your NEC plasma monitor and keep the manual handy for future reference.


CAUTION




**RISK OF ELECTRIC SHOCK
DO NOT OPEN**



CAUTION: TO REDUCE THE RISK OF ELECTRIC SHOCK, DO NOT REMOVE COVER. NO USER-SERVICEABLE PARTS INSIDE. REFER SERVICING TO QUALIFIED SERVICE PERSONNEL.

 This symbol warns the user that uninsulated voltage within the unit may have sufficient magnitude to cause electric shock. Therefore, it is dangerous to make any kind of contact with any part inside of this unit.

 This symbol alerts the user that important literature concerning the operation and maintenance of this unit has been included. Therefore, it should be read carefully in order to avoid any problems.

WARNING

TO PREVENT FIRE OR SHOCK HAZARDS, DO NOT EXPOSE THIS UNIT TO RAIN OR MOISTURE. ALSO DO NOT USE THIS UNIT'S POLARIZED PLUG WITH AN EXTENSION CORD RECEPTACLE OR OTHER OUTLETS, UNLESS THE PRONGS CAN BE FULLY INSERTED. REFRAIN FROM OPENING THE CABINET AS THERE ARE HIGH-VOLTAGE COMPONENTS INSIDE. REFER SERVICING TO QUALIFIED SERVICE PERSONNEL.

WARNING

This is a Class A product. In a domestic environment, this product may cause radio interference in which case the user may be required to take adequate measures.

Warnings and Safety Precaution

The NEC plasma monitor is designed and manufactured to provide long, trouble-free service. No maintenance other than cleaning is required. Use a soft dry cloth to clean the panel. Never use solvents such as alcohol or thinner to clean the panel surface.

The plasma display panel consists of fine picture elements (cells). Although NEC produces the plasma display panels with more than 99.99 percent active cells, there may be some cells that do not produce light or remain lit.

For operating safety and to avoid damage to the unit, read carefully and observe the following instructions. To avoid shock and fire hazards:

1. Provide adequate space for ventilation to avoid internal heat build-up. Do not cover rear vents or install the unit in a closed cabinet or shelves.
The unit is equipped with cooling fans. If you install the unit in an enclosure, make sure there is adequate space at the top of the unit to allow hot air to rise and escape. If the monitor becomes too hot, the overheat protector will be activated and the monitor will be turned off. If this happens, turn off the power to the monitor and unplug the power cord. If the room where the monitor is installed is particularly hot, move the monitor to a cooler location, and wait for the monitor to cool for 60 minutes. If the problem persists, contact your NEC dealer for service.
2. Do not use the power cord polarized plug with extension cords or outlets unless the prongs can be completely inserted.
3. Do not expose the unit to water or moisture.
4. Avoid damage to the power cord, and do not attempt to modify the power cord.
5. Unplug the unit during electrical storms or if the unit will not be used over a long period.
6. Do not open the cabinet which has potentially dangerous high voltage components inside. If the unit is damaged in this way the warranty will be void. Moreover, there is a serious risk of electric shock.
7. Do not attempt to service or repair the unit. NEC is not liable for any bodily harm or damage caused if unqualified persons attempt service or open the back cover. Refer all service to authorized NEC Service Centers.

NOTE:

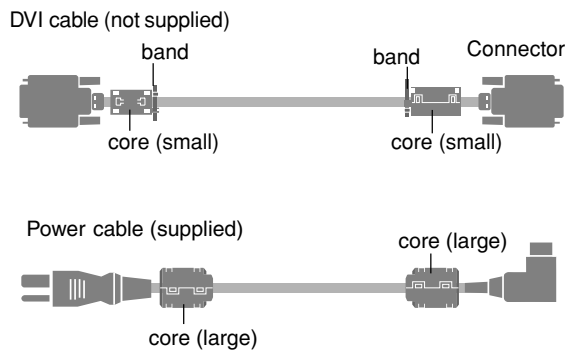
When you connect a computer to this monitor, attach the supplied ferrite cores. If you do not do this, this monitor will not conform to mandatory CE or C-Tick standards.

Attaching the ferrite cores:

Set the ferrite cores on both ends of the DVI cable (not supplied), and both ends of the power cable (supplied).

Close the lid tightly until the clamps click.

Use the band to fasten the ferrite core (supplied) to the DVI cable.



To avoid damage and prolong operating life:

1. Use only with 100-240V 50/60Hz AC power supply. Continued operation at line voltages greater than 100-240 Volts AC will shorten the life of the unit, and might even cause a fire hazard.
2. Handle the unit carefully when installing it and do not drop.
3. Set the unit away from heat, excessive dust, and direct sunlight.
4. Protect the inside of the unit from liquids and small metal objects. In case of accident, unplug the unit and have it serviced by an authorized NEC Service Center.
5. Do not hit or scratch the panel surface as this causes flaws on the surface of the screen.
6. For correct installation and mounting it is strongly recommended to use a trained, authorized NEC dealer.
7. As is the case with any phosphor-based display (like a CRT monitor, for example) light output will gradually decrease over the life of a Plasma Display Panel.

Recommendations to avoid or minimize phosphor burn-in

Like all phosphor-based display devices and all other gas plasma displays, plasma monitors can be susceptible to phosphor burn under certain circumstances. Certain operating conditions, such as the continuous display of a static image over a prolonged period of time, can result in phosphor burn if proper precautions are not taken. To protect your investment in this NEC plasma monitor, please adhere to the following guidelines and recommendations for minimizing the occurrence of image burn:

- * Always enable and use your computer's screen saver function during use with a computer input source.
- * Display a moving image whenever possible.
- * Change the position of the menu display from time to time.
- * Always power down the monitor when you are finished using it.

If the plasma monitor is in long term use or continuous operation take the following measures to reduce the likelihood of phosphor burn:

- * Lower the Brightness and Contrast levels as much as possible without impairing image readability.
- * Display an image with many colors and color gradations (i.e. photographic or photo-realistic images).
- * Create image content with minimal contrast between light and dark areas, for example white characters on black backgrounds. Use complementary or pastel color whenever possible.
- * Avoid displaying images with few colors and distinct, sharply defined borders between colors.

Contact an NEC affiliate or authorized dealer for other recommended procedures that will best suit your particular application needs.

Contents

How to Attach Options to the Plasma Monitor .. E-1

Introduction E-2

Introduction to the PlasmaSync 61MP1	
Plasma Monitor	E-2
The features you'll enjoy include:	E-2
Contents of the Package	E-2
Options	E-2

Part Names and Function E-3

Front View	E-3
Rear View / Terminal Board	E-4
Remote Control	E-5
Battery Installation and Replacement	E-6
Using the wired remote control mode	E-7
Operating Range	E-7
Handling the remote control	E-7

Installation E-8

Connecting Your PC or Macintosh Computer	E-9
Connections with Equipment that has a Digital Interface	E-9
Connecting Your Document Camera	E-9
Connecting Your VCR or Laser Disc Player	E-9
Connecting Your DVD Player	E-9
External Speaker Connections	E-10
Pin Assignments and Signal Levels for 15 pin RGB (Analog)	E-11
Pin Configuration and Signal of the RGB 3 IN Connector (DVI Connector)	E-11

Basic Operations E-12

POWER	E-12
To turn the unit ON and OFF:	E-12
VOLUME	E-12
To adjust the volume:	E-12
MUTE	E-12
To cancel the sound:	E-12
DISPLAY	E-12
To check the settings:	E-12
DIGITAL ZOOM	E-12
AUTO ADJUST	E-12
To adjust the size or quality of the picture automatically:	E-12
OFF TIMER	E-13
To set the off timer:	E-13
To check the remaining time:	E-13
To cancel the off timer	E-13

WIDE Operations E-14

Watching with a wide screen (manual)	E-14
When watching videos or digital video discs	E-14
When watching high definition video source	E-14
Watching computer images with a wide screen	E-15
When "PICTURE SIZE" is set to "OFF"	E-15

MULTI SCREEN Operations E-16

Showing a couple of pictures on the screen at the same time	E-16
Selecting the input signals to be displayed	E-16
Adjusting the OSM controls	E-16

OSM Controls E-17

Menu Operations	E-17
Picture Settings Menu	E-19
Adjusting the picture	E-19
Setting the picture mode according to the brightness of the room	E-20
Setting the color temperature	E-21
Adjusting the color to the desired quality	E-22
Reducing noise in the picture	E-23
Sound Settings Menu	E-24
Adjusting the treble, bass and left/right balance	E-24
Screen Settings Menu	E-25
Adjusting the Position, Size, Fine Picture, Picture Adj	E-25
Function Settings Menu	E-26
Setting the on-screen menu	E-26
Adjusting the position of the menu display	E-27
Setting the power management for computer images	E-28
POWER/STANDBY indicator	E-29
Setting the gray level for the sides of the screen	E-30
Setting the picture to suit the movie	E-30
Setting RGB3 ADJ.	E-31
Reducing burn-in of the screen	E-31
Resetting to the default values	E-32
Option Settings Menu	E-33
Setting the allocation of the audio connectors	E-33
Setting the BNC connectors	E-33
Setting a computer image to the correct RGB select screen	E-34
Setting high definition images to the suitable screen size	E-35
Setting the picture size for RGB input signals	E-36
Information Menu	E-36
Checking the frequencies, polarities of input signals, and resolution	E-36
Setting the language for the menus	E-37
Setting the video signal format	E-37

External Control E-39

Table of Signals Supported E-47

Supported resolution	E-47
----------------------------	------

Troubleshooting E-49

Specifications E-50

How to Attach Options to the Plasma Monitor

You can attach your optional mounts or stand to the plasma monitor in the following way:

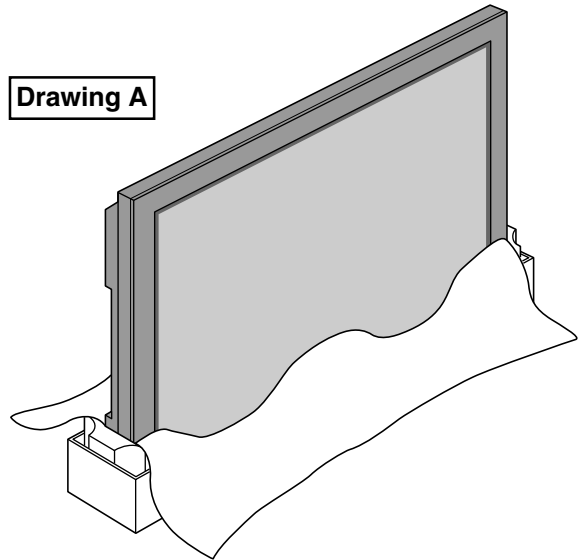
- * Unpack the plasma monitor. (See Drawing A.)
- * Take it out, put your hand in the handy-grip recess at the rear, and move it to an appropriate place. Then attach the optional mounts or stand. (See Drawing B.)

- **This device cannot be installed on its own. Be sure to use a stand or original mounting unit. (Wall mount unit, Stand, etc.)**
- * See page E-2.
- **For correct installation and mounting it is strongly recommended to use a trained, authorized NEC dealer.**

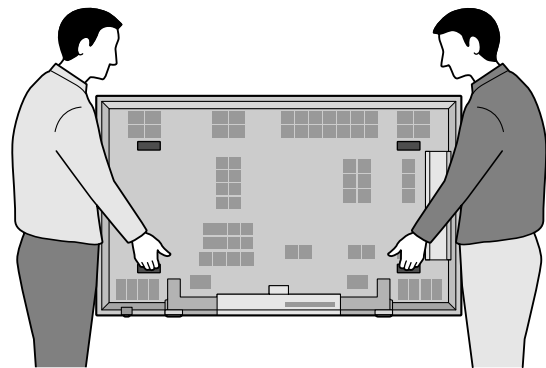
Failure to follow correct mounting procedures could result in damage to the equipment or injury to the installer.

Product warranty does not cover damage caused by improper installation.

Drawing A

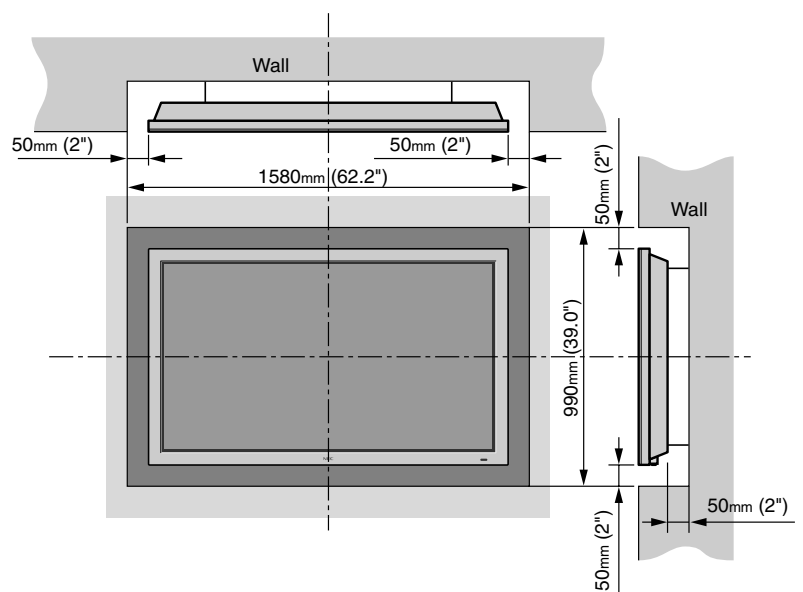


Drawing B



Ventilation Requirements for enclosure mounting

To allow heat to disperse, leave space between surrounding objects as shown on the diagram below when installing.



Introduction

Introduction to the PlasmaSync 61MP1 Plasma Monitor

NEC's PlasmaSync is a seamless blend of cutting-edge visual technology and sophisticated design. At 61-inches, with a 16:9 aspect ratio, the PlasmaSync 61MP1 certainly makes a big impression. However, at a mere 4.7 inches/119 mm thin, the monitor's sleek techno-art lines blend in well with your environment. PlasmaSync's crisp, vivid image quality will transform data from any graphic medium from PCs to DVD players- into art. And weighing only 134.5 lbs/ 61 kg, it actually can be hung almost anywhere. NEC has made sure that a host of multimedia resources can be easily connected and displayed as brilliantly as intended on the PlasmaSync monitor.

The features you'll enjoy include:

- 61-inch screen
- 16:9 aspect ratio
- Capsulated Color Filter (CCF) and black matrix
- The enhanced display in red uses a two-stage filtering system where Accurimson is combined with our special CCF.
- 4.7 inch / 119 mm thin
- 134.5 lbs/ 61 kg light
- High-resolution screen: 1365 × 768 pixels
- 160-degrees of off-axis viewing, horizontally and vertically.
- Flicker - and warp - free display provides excellent image geometry even in screen corners
- Not affected by magnetic fields, no color drift or edge distortion.
- VGA, SVGA, XGA, SXGA, computer signal compatibility
- NTSC, PAL, SECAM, composite and S-Video signal compatibility
- 480P, 1080I, 720P and HDTV signal compatibility
- PCs, VCRs, Laser Disc and DVD player source compatibility
- AccuBlend scan conversion automatically converts VGA, SVGA and SXGA signals to the panel's native resolution
- Advanced Mass Area Sampling Progressive Scan method is employed.
- RGB input (3*), Video input (3), DVD/HD input (2*), Audio input (3), External Control input (1)
- AccuColor control system provides user selectable on-screen color temperature settings
- New Drive Technology
- Component video input terminal for DVD, 15.75kHz (Y, CB, CR)
- Digital broadcasting source compatibility
- NEC's OSM menu-driven on screen control system that makes image adjustments a snap
- Seven languages (English, German, French, Italian, Spanish, Swedish, and Japanese)
- A handy-grip recess is provided to facilitate installation and movement.

* You can select RGB source or Component source for the 5BNC terminal. When selecting an RGB input, the source is switched to the RGB input (3); when selecting a component input, the source is switched to the DVD/HD input (2).

Contents of the Package

- PlasmaSync 61MP1 plasma monitor
- Power cord
- RGB cable (Mini D-Sub 15-pin to Mini D-Sub 15-pin connector)
- Remote control with two AAA Batteries
- User's manual
- Remote cable
- Safety metal fittings*
- Ferrite core (small × 2, large × 2), band

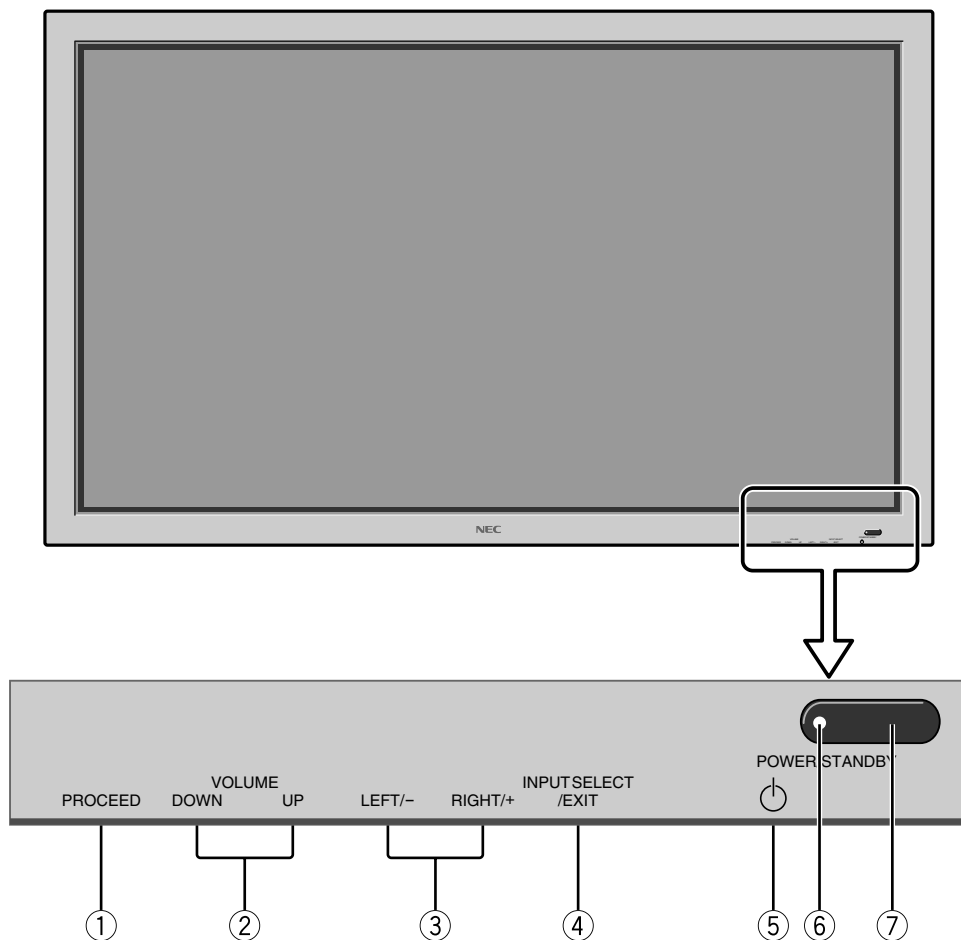
* These are fittings for fastening the unit to a wall to prevent tipping due to external shock when using the stand (option). Screw the safety fittings to the holes in the back of the monitor.

Options

- Wall mount unit
- Ceiling mount unit
- Tilt mount unit
- Tabletop stand
- Speakers
- Others

Part Names and Function

Front View



① **PROCEED**
Sets the On-Screen Menu (OSM) mode and displays the main menu.

② **VOLUME DOWN and UP**
Adjusts the volume. Functions as the CURSOR (▲/▼) buttons in the On-Screen Menu (OSM) mode.

③ **LEFT/- and RIGHT/+**
Enlarges or reduces the image. Functions as the CURSOR (◀/▶) buttons in the On-Screen Menu (OSM) mode.

④ **INPUT SELECT / EXIT**
Switches the input, in the following order:

→ VIDEO1 → VIDEO2 → VIDEO3 → DVD/HD
← RGB/PC3 ← RGB/PC2 ← RGB/PC1 ←

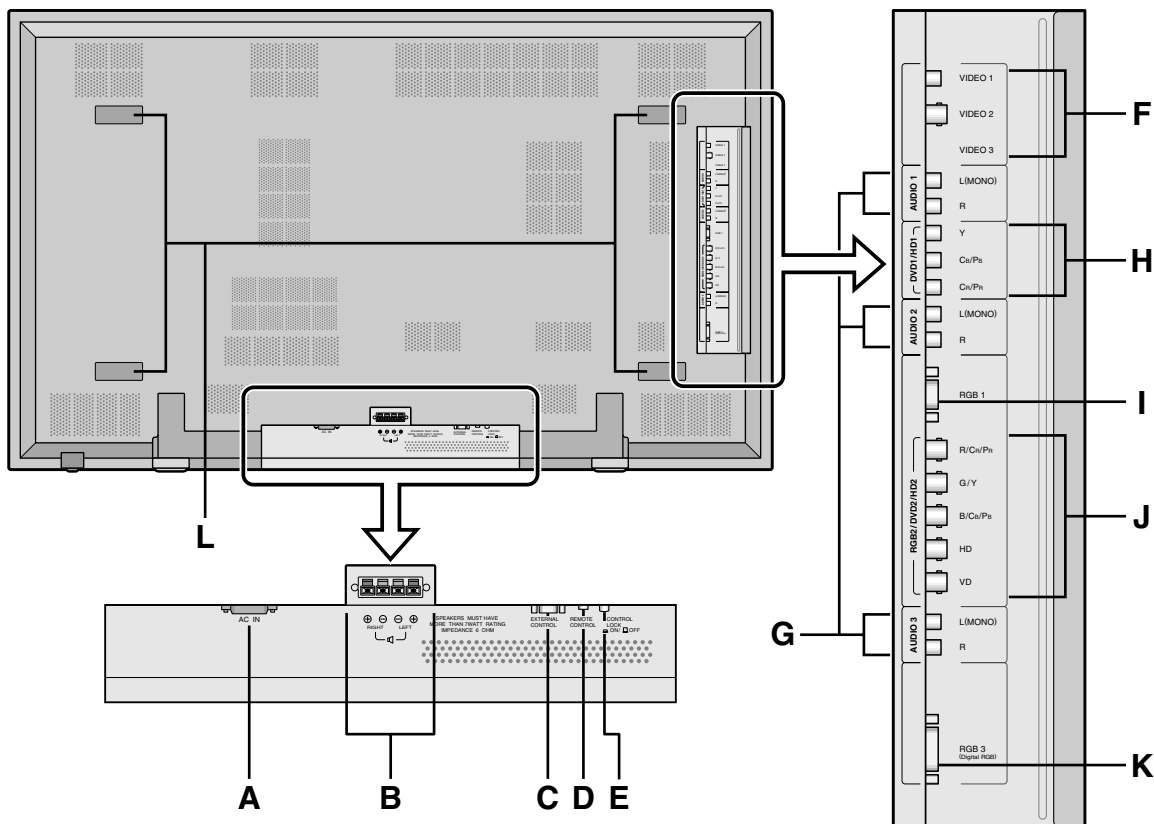
Functions as the EXIT buttons in the On-Screen Menu (OSM) mode.

⑤ **Power**
Turns the monitor's power on and off.

⑥ **POWER/STANDBY indicator**
When the power is on Lights green.
When the power is in the standby mode ... Lights red.

⑦ **Remote sensor window**
Receives the signals from the remote control.

Rear View/ Terminal Board



A AC IN

Connect the included power cord here.

B EXT SPEAKER L and R

Connect speakers here. Maintain the correct polarity.

C EXTERNAL CONTROL

This terminal is used when power ON/OFF, input selection and AUDIO MUTE and other controls are operated externally (by external control). See also page E-39 for external control.

D REMOTE CONTROL

Connect the supplied remote cable here.

E CONTROL LOCK

When "CONTROL LOCK" is set "ON", the buttons on the set's control panel do not function.

F VIDEO1, 2, 3

Connect VCR's, DVD's or Laser Discs, etc. here.

G AUDIO1, AUDIO2, AUDIO3

These are audio input terminals.

The input is selectable. Set which video image to allot them to on the menu screen.

H DVD1 / HD1

Connect DVD's, High Definition or Laser Discs, etc. here.

I RGB1

Inputs the analog RGB signal of personal computer, etc.

J RGB2/ DVD2/ HD2

RGB2: Inputs the analog RGB signal.

DVD2/ HD2: Connect DVD's, High Definition or Laser Discs, etc. here.

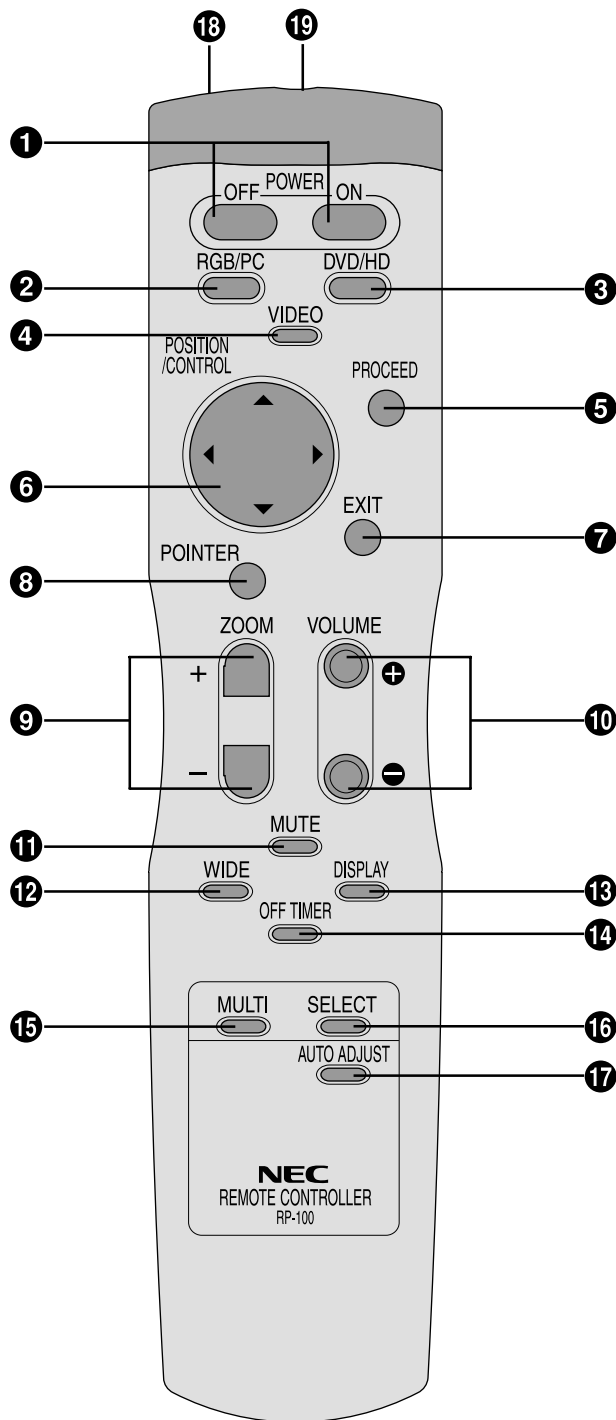
K RGB3 (DVI 29pin)

Inputs a digital RGB signal (TMDS).

L Handy-Grip recess

Use the recesses (as shown) when you need to carry the display.

Remote Control



1 POWER ON/OFF

Switches Power ON/OFF.
(This does not operate when POWER/STANDBY indicator of the main unit is off.)

2 RGB/PC

Press this button to select RGB/PC as the source.

→ RGB/PC1 → RGB/PC2 → RGB/PC3 →

RGB/PC can also be selected using the INPUT SELECT button on the monitor. The input switches as follows each time the button is pressed:

→ VIDEO1 → VIDEO2 → VIDEO3 → DVD/HD →
RGB/PC3 ← RGB/PC2 ← RGB/PC1 ←

3 DVD / HD

Press this button to select DVD/HD as the source. DVD/HD can also be selected using the INPUT SELECT button on the monitor. The input switches as follows each time the button is pressed:

→ VIDEO1 → VIDEO2 → VIDEO3 → DVD/HD →
RGB/PC3 ← RGB/PC2 ← RGB/PC1 ←

4 VIDEO

Press this button to select VIDEO as the source.

→ VIDEO1 → VIDEO2 → VIDEO3 →

VIDEO can also be selected using the INPUT SELECT button on the monitor. The input switches as follows each time the button is pressed:

→ VIDEO1 → VIDEO2 → VIDEO3 → DVD/HD →
RGB/PC3 ← RGB/PC2 ← RGB/PC1 ←

5 PROCEED

Press this button to access the OSM controls. Press this button during the display of the main menu to go to the sub menu.

6 CURSOR (▲ / ▼ / ◀ / ▶)

Use these buttons to select items or settings and to adjust settings or switch the display patterns.

7 EXIT

Press this button to exit the OSM controls in the main menu. Press this button during the display of the sub menu to return to the main menu.

8 POINTER

Press this button to display the pointer.

9 ZOOM (+ / -)

Enlarges or reduces the image.

10 VOLUME (+ / -)

Adjusts the volume.

11 MUTE

Mutes the sound.

12 WIDE

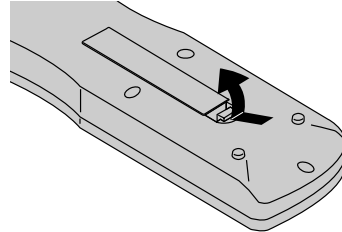
The type of broadcast is detected automatically, and the recommended wide screen is set.

-
- 13 DISPLAY**
Displays the source settings on the screen.
 - 14 OFF TIMER**
Activates the off timer for the unit.
 - 15 MULTI**
Press this button to select a screen mode from among single mode, side by side, and picture in picture.
 - 16 SELECT**
Press this button to select the active picture in a multi screen mode.
 - 17 AUTO ADJUST**
Press this button to adjust Fine Picture, Picture ADJ, Position, and Contrast automatically, or to switch the screen size to ZOOM mode automatically with the superimposed caption displayed fully only when the picture contains dark areas above and below the picture.
 - 18 Remote control signal transmitter**
Transmits the remote control signals.
 - 19 Remote Jack**
Insert the plug of the supplied remote cable here when using the supplied remote control in the wired condition.

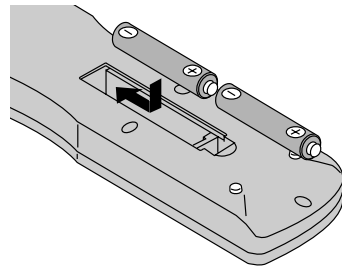
Battery Installation and Replacement

Insert the 2 “AAA” batteries, making sure to set them in with the proper polarity.

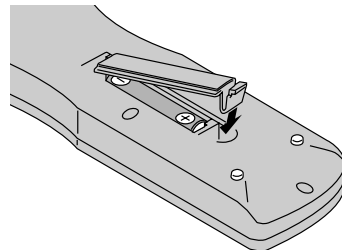
1. Press and open the cover.



2. Align the batteries according to the (+) and (-) indication inside the case.



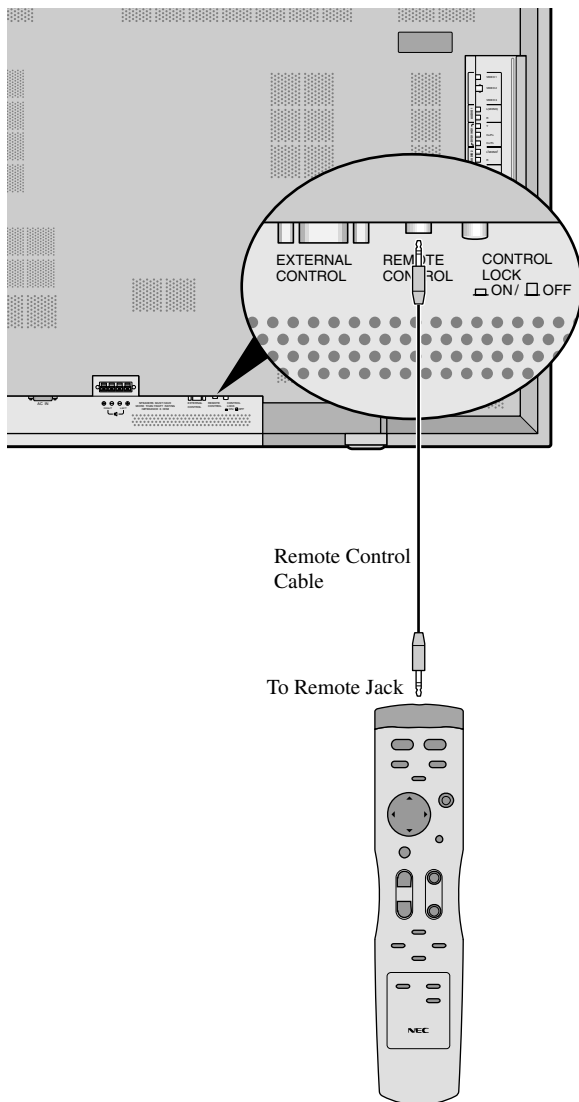
3. Replace the cover.



Using the wired remote control mode

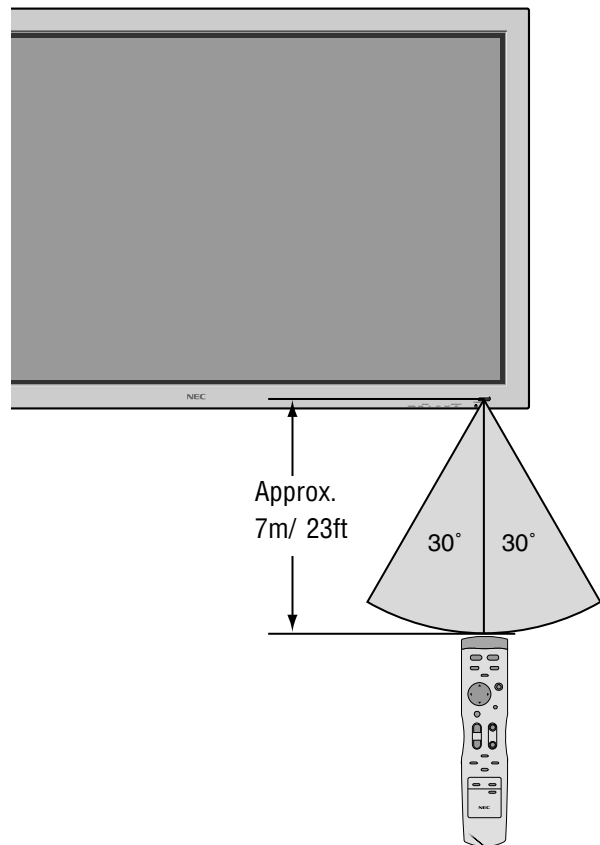
Connect the supplied remote cable to the remote control's remote jack and the "REMOTE CONTROL" terminal on the monitor.

When the cable is connected, the mode automatically switches to wired remote control. When the wired remote control mode is used, the remote control can be operated even if no batteries are loaded.



Operating Range

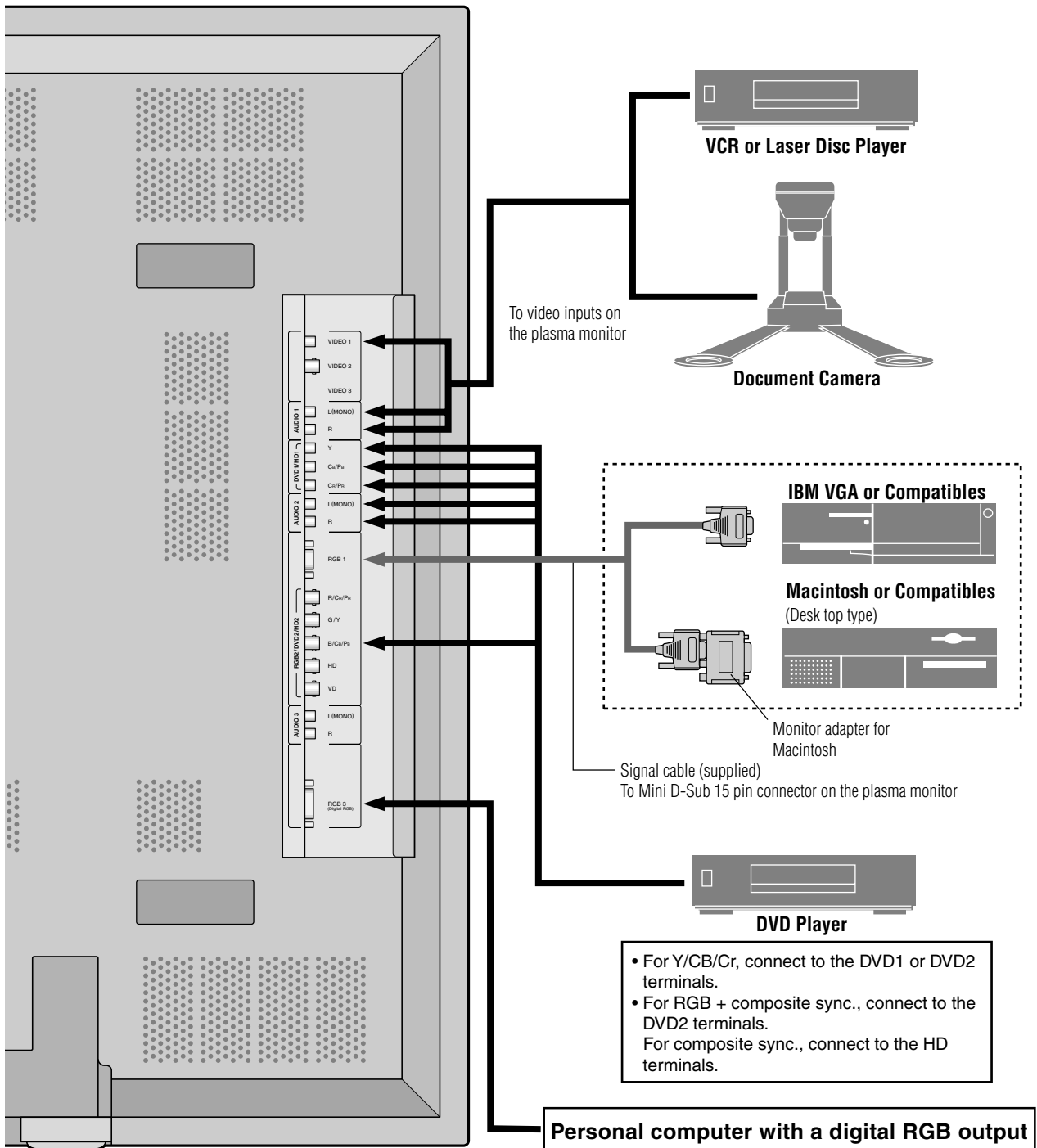
- * Use the remote control within a distance of about 7 m/ 23ft. from the front of the monitor's remote control sensor and at horizontal and vertical angles of up to approximately 30°.
- * The remote control operation may not function if the monitor's remote control sensor is exposed to direct sunlight or strong artificial light, or if there is an obstacle between the sensor and the remote control.



Handling the remote control

- Do not drop or mishandle the remote control.
- Do not get the remote control wet. If the remote control gets wet, wipe it dry immediately.
- Avoid heat and humidity.
- When not using the remote control for a long period, remove the batteries.
- Do not use new and old batteries together, or use different types together.
- Do not take apart the batteries, heat them, or throw them into a fire.
- When using the remote control in the wireless condition, be sure to unplug the remote cable from the REMOTE CONTROL terminal on the monitor.

Installation



Note: This PlasmaSync monitor has the capability to display images when connected to European DVD players with a SCART output signal, which is RGB with composite sync.

NEC can supply a special SCART cable, which will enable you to use the RGB with composite sync signal.

To obtain the special cable as well as for further information, please contact NEC help desk 0181 752 3535.

Please refer to page E-33 for selection of the correct mode in the on-screen manager.

Connecting Your PC or Macintosh Computer

Connecting your PC or Macintosh computer to your plasma monitor will enable you to display your computer's screen image for an impressive presentation. The plasma monitor supports the signals described on page E-47.

To connect a PC, Macintosh or compatible graphics adapter, simply:

1. Turn off the power to your plasma monitor and computer.
2. If your PC does not support XGA/SVGA/VGA you will need to install an XGA/SVGA/VGA graphics board. Consult your computer's owner's manual for your XGA/SVGA/VGA configuration. If you need to install a new board, see the manual that comes with your new graphics board for installation instructions.
3. The plasma monitor provides signal compatibility up to VESA 1600 × 1200 (UXGA). However, it is not recommended to use this resolution due to image readability on the monitors 1365 × 768 native pixel resolution panel.
4. Use the signal cable that's supplied to connect your PC or Macintosh computer to the plasma monitor. For Macintosh, use the monitor adapter to connect to your computer's video port.
5. Turn on the plasma monitor and the computer.
6. If the plasma monitor goes blank after a period of inactivity, it may be caused by a screen saver installed on the computer you've connected to the plasma monitor.

When using a Macintosh with the plasma monitor, the following four display standards are supported using the Macintosh adapter :

- 13" fixed mode
- 16" fixed mode
- 19" fixed mode
- 21" fixed mode

The 19" fixed mode is recommended for the plasma monitor.

Connections with Equipment that has a Digital Interface

Connections can be made with equipment that is equipped with a digital interface compliant with the DVI (Digital Visual Interface) standard.

* Use a DVI 29-pin signal cable and the ferrite cores (supplied) when making connections to the RGB3 IN (DVI) connector of the main unit.

Note that the RGB3 IN(DVI) terminal does not support analog RGB input source.

Note:

1. Input TMDS signals conforming to DVI standards. The TMDS input corresponds to 1 link.
2. To maintain display quality, use a cable with a quality prescribed by DVI standards that is within 5 meters in length.

Connecting Your Document Camera

You can connect your plasma monitor to a document camera. To do so, simply:

1. Turn off the power to your plasma monitor and document camera.
2. Use a standard video cable to connect your document camera to the Video input on your plasma monitor.
3. Turn on the plasma monitor and the document camera.

Note: Refer to your document camera owner's manual for more information about your camera's video output requirements.

Connecting Your VCR or Laser Disc Player

Use common RCA cables (not provided) to connect your VCR or laser disc player to your plasma monitor. To make these connections, simply:

1. Turn off the power to your plasma monitor and VCR or laser disc player.
2. Connect one end of your RCA cable to the video output connector on the back of your VCR or laser disc player, connect the other end to the Video input on your plasma monitor. Use standard RCA audio patch cords to connect the audio from your VCR or laser disc player to your plasma monitor (if your VCR or laser disc player has this capability). Be careful to keep your right and left channel connections correct for stereo sound.
3. Turn on the plasma monitor and the VCR or laser disc player.

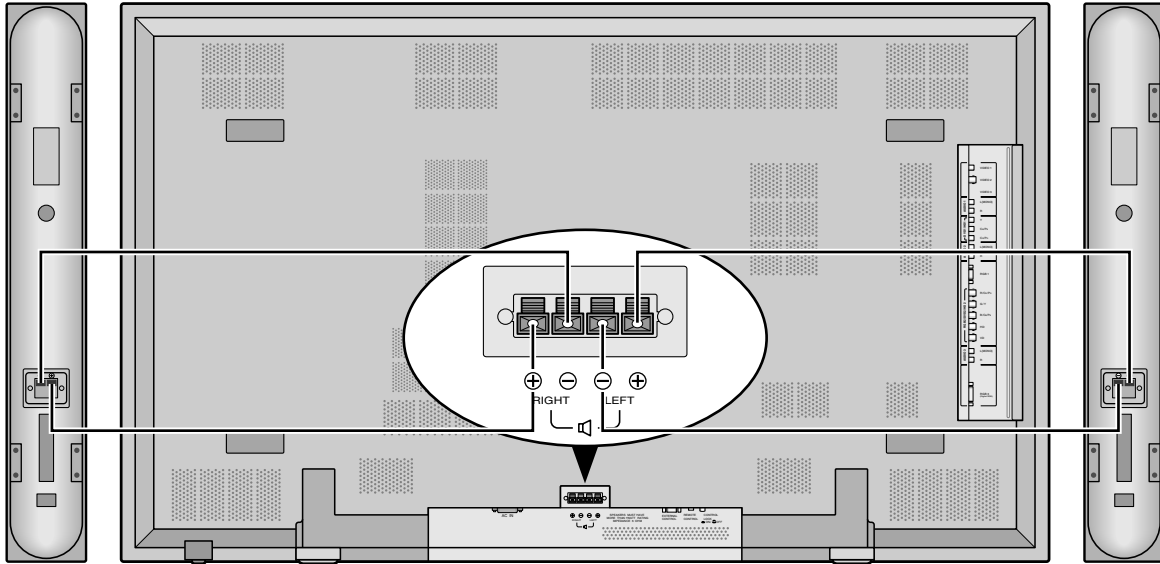
Note: Refer to your VCR or laser disc player owner's manual for more information about your equipment's video output requirements.

Connecting Your DVD Player

You can connect your plasma monitor to a DVD player. To do so, simply:

1. Turn off the power to your plasma monitor and DVD player.
2. Use a standard video cable to connect your DVD player to the Y, Cb, and Cr inputs on your plasma monitor. Or use the DVD-player's S-Video output. Use a standard S-Video cable to connect to the S-Video input on the plasma monitor.
3. Turn on the plasma monitor and the DVD player.

External Speaker Connections



External speakers may be connected to the plasma monitor to reproduce sound from VIDEO, DVD or RGB signal sources.

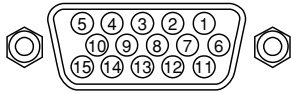
External speakers may be connected directly to the SPEAKERS terminals or indirectly by connecting a stereo system amplifier to the audio outputs.

CAUTION: *Unplug the plasma monitor and all connected components before connecting external speakers. Use only speakers with 6-ohm impedance and a power input rating of 7 watts or more.*

To connect external speakers directly to the plasma monitor:

1. Strip the ends of the speaker wires.
2. Press down the tabs below the SPEAKERS terminals, insert the speaker wire and release the tab to secure the speaker wire connection:
 - [a] Connect the right speaker (located at right side of the monitor when viewed from the front) positive (+) wire to RIGHT +.
 - [b] Connect the right speaker negative (-) wire to RIGHT -.
 - [c] Connect the left speaker negative (-) wire to LEFT-.
 - [d] Connect the left speaker positive (+) wire to LEFT+.

Pin Assignments and Signal Levels for 15 pin RGB (Analog)



Pin No.	Signal (Analog)
1	Red
2	Green or sync-on-green
3	Blue
4	No connection
5	Ground
6	Red ground
7	Green ground
8	Blue ground
9	No connection
10	Sync signal ground
11	No connection
12	Bi-directional DATA (SDA)
13	Horizontal sync or Composite sync
14	Vertical sync
15	Data clock

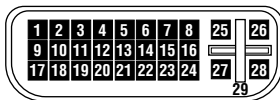
Pin Configuration and Signal of the RGB 3 IN Connector (DVI Connector)

The unit is equipped with a type of connector commonly used for both analog and digital.

(Functionally, this cannot be used for an analog input.)

(TMDS can be used for one link only.)

RGB 3



Pin No.	Signal (Digital)
1	T.M.D.S Data 2 -
2	T.M.D.S Data 2 +
3	T.M.D.S Data 2 Shield
4	No connection
5	No connection
6	DDC Clock
7	DDC Data
8	No connection
9	T.M.D.S Data 1 -
10	T.M.D.S Data 1 +
11	T.M.D.S Data 1 Shield
12	No connection
13	No connection
14	+5V Power
15	Ground
16	Hot Plug Detect
17	T.M.D.S Data 0 -
18	T.M.D.S Data 0 +
19	T.M.D.S Data 0 Shield
20	No connection
21	No connection
22	T.M.D.S Clock Shield
23	T.M.D.S Clock +
24	T.M.D.S Clock -
25	No connection
26	No connection
27	No connection
28	No connection
29	No connection

Basic Operations

POWER

To turn the unit ON and OFF:

1. Plug the power cord into an active AC power outlet.
2. Press the POWER ON button (on the remote control) to turn on the unit.

The monitor's POWER/STANDBY indicator will light up (green) when the unit is on.

3. Press the POWER OFF button (on the remote control or the unit) to turn off the unit.

The monitor's POWER/STANDBY indicator turns red and the standby mode is set (only when turning off the unit with the remote control).

VOLUME

To adjust the volume:

1. Press and hold the VOLUME \oplus button (on the remote control or the unit) to increase to the desired level.
2. Press and hold the VOLUME \ominus button (on the remote control or the unit) to decrease to the desired level.

MUTE

To cancel the sound:

Press the MUTE button on the remote control to cancel the sound; press again to restore.


DISPLAY

To check the settings:

1. The screen changes each time the DISPLAY button is pressed.
2. If the button is not pressed for approximately three seconds, the menu turns off.


DIGITAL ZOOM

Digital zoom specifies the picture position and enlarges the picture.

1. Press the POINTER button to display the pointer. ()

To change the size of the picture:

Press the ZOOM+ button and enlarge the picture.

The pointer will change to resemble a magnifying glass. ()

A press of the ZOOM- button will reduce the picture and return it to its original size.

To change the picture position:

Select the position with the \blacktriangle \blacktriangledown \blacktriangleleft \blacktriangleright buttons.

2. Press the POINTER button to delete the pointer.

AUTO ADJUST

To adjust the size or quality of the picture automatically:

Press the AUTO ADJUST button.

Information

■ AUTO ADJUST ON setting

When RGB (still picture) input is selected Fine Picture, Picture ADJ, Position, and Contrast will be adjusted automatically.

When RGB (motion picture), VIDEO, or Y/Pb/Pr (component) input is selected The screen size switches to ZOOM mode automatically with the superimposed caption displayed fully only when the picture contains dark areas above and below the picture.

OFF TIMER

To set the off timer:

The off timer can be set to turn the power off after 30, 60, 90 or 120 minutes.

1. Press the OFF TIMER button to start the timer at 30 minutes.
2. Press the OFF TIMER button to the desired time.
3. The timer starts when the menu turns off.

→ 30 → 60 → 90 → 120 → 0



OFF TIMER30

To check the remaining time:

1. Once the off timer has been set, press the OFF TIMER button once.
2. The remaining time is displayed, then turns off after a few seconds.
3. When five minutes remain the remaining time appears until it reaches zero.



OFF TIMER28

To cancel the off timer:

1. Press the OFF TIMER button twice in a row.
2. The off timer is canceled.



OFF TIMER0

Note:

After the power is turned off with the off timer ... A slight current is still supplied to the monitor. When you are leaving the room or do not plan to use the system for a long period of time, turn off the power of the monitor.

WIDE Operations

Watching with a wide screen (manual)

With this function, you can select one of four screen sizes.

When watching videos or digital video discs

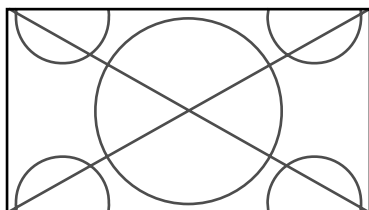
1. Press the WIDE button on the remote control.
2. *Within 3 seconds ...*

Press the WIDE button again.

The screen size switches as follows:

→ ZOOM → NORMAL → FULL → STADIUM →

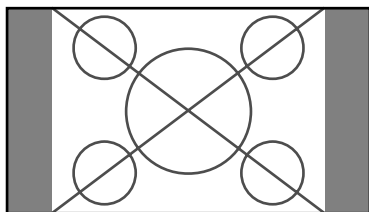
ZOOM size screen



The picture is expanded in the horizontal and vertical direction, maintaining the original proportions.

* Use this for theater size (wide) movies, etc.

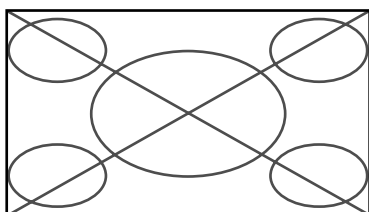
NORMAL size screen (4:3)



The normal size screen is displayed.

* The picture has the same size as video pictures with a 4 : 3 aspect ratio.

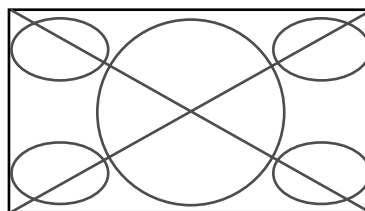
FULL size screen



The image is expanded in the horizontal direction.

* Images compressed in the horizontal direction (“squeezed images”) are expanded in the horizontal direction and displayed on the entire screen. (Normal images are expanded in the horizontal direction.)

STADIUM size screen



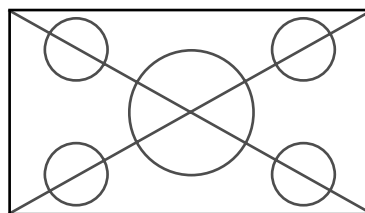
The picture is expanded in the horizontal and vertical directions at different ratios.

* Use this for watching normal video programs (4:3) with a wide screen.

When watching high definition video source

1. Press the WIDE button on the remote control.

FULL size screen (16 : 9)



The full size screen is displayed.

* The picture has the same size as video pictures (16 : 9).

Watching computer images with a wide screen

Switch to the wide screen mode to expand the 4 : 3 image to fill the entire screen.

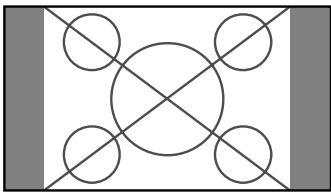
1. Press the WIDE button on the remote control.
2. *Within 3 seconds ...*

Press the WIDE button again.

The screen size switches as follows:

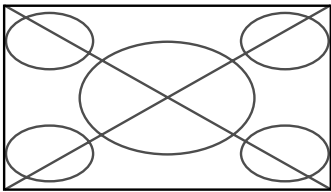
→ NORMAL → FULL ←

NORMAL size screen (4:3 or SXGA 5:4)



The picture has the same size as the normal computer image.

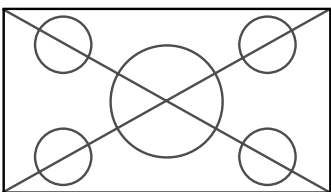
FULL size screen



The image is expanded in the horizontal direction.

When wide signals are input.

FULL size screen

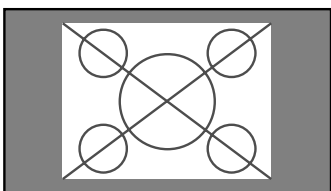


When "PICTURE SIZE" is set to "OFF"

The screen size switches as follows:

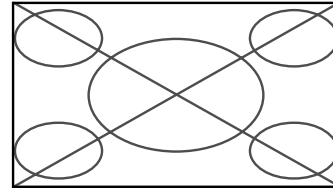
→ TRUE → FULL ←

TRUE size screen (VGA, SVGA 4:3)



The image is true resolution.

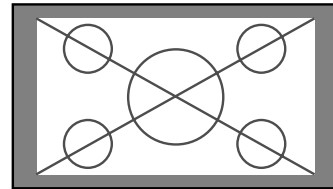
FULL size screen



The image is expanded in the horizontal and vertical direction.

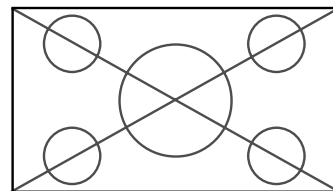
When wide signals are input.

TRUE



The image is true resolution.

FULL



Information

■ Supported resolution

See page E-47 for details on the display output of the various VESA signal standards supported by the monitor.

■ "PICTURE SIZE" setting

When the setting of "PICTURE SIZE" is OFF, the size of RGB-input pictures will be TRUE in place of NORMAL.

■ When 852 (848) dot × 480 line wide VGA* signals with a vertical frequency of 60 Hz and horizontal frequency of 31.7 (31.0) kHz are input

Select an appropriate setting for RGB SELECT mode referring to the "Table of Signals Supported" on page E-47.

* "IBM PC/AT" and "VGA" are registered trademarks of IBM, Inc. of the United States.

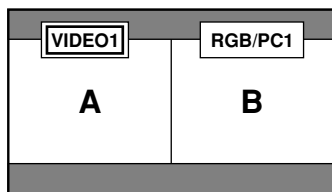
MULTI SCREEN Operations

Showing a couple of pictures on the screen at the same time

* An RGB-input picture may not be displayed in these modes, depending on the input signal specifications.

1. Press the MULTI button to select a screen mode from among single mode, side by side, and picture in picture.

Side by side 1

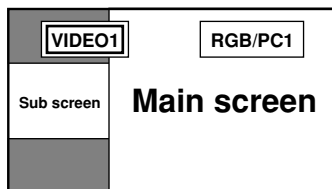


Press the cursor buttons ◀▶ on the remote control to switch either side by side 1 (with ▶) or side by side 2 (with ◀).

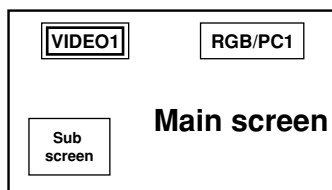
Note:

Picture A and B on the above screen are not always of the same height.

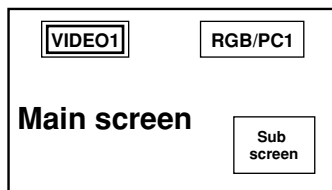
Side by side 2



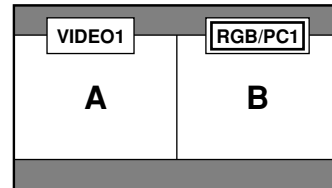
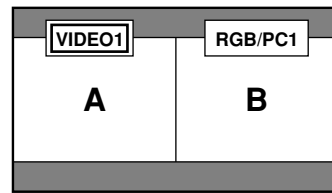
Picture in picture



Press the cursor buttons ◀▶ on the remote control to switch the position of the sub screen.



2. If you wish to switch the setting of the picture, press the SELECT button to make the desired picture active. Each press of the SELECT button changes the selection of the active picture.



Selecting the input signals to be displayed

1. Press the SELECT button to make the desired picture active.
2. Press the RGB/PC, VIDEO, or DVD/HD button. Each press of the button changes the selection of the input signal. The INPUT SELECT button on the monitor can also be used to change the selection.

Adjusting the OSM controls

1. Press the PROCEED button to display the MAIN MENU.
2. Adjust the setting to your preference. For details, see "OSM (On Screen Menu) Controls" on page E-17.

Note:

During multi mode, Auto Adjust does not affect the screen.

Information

■ Positioning on the screen (for side by side)

Depending on the input-signal selection, positioning of the picture is settled as follows.

Pictures displayed

on the left VIDEO1, VIDEO2, VIDEO3, HD1/DVD1/DTV1, or HD2/DVD2/DTV2

Pictures displayed

on the right RGB/PC1, RGB/PC2, RGB/PC3

■ Positioning on the screen (for picture in picture)

Pictures displayed

Main screen RGB/PC1, RGB/PC2, RGB/PC3, HD 1/DVD 1/DTV 1, or HD 2/DVD 2/DTV 2

Sub screen VIDEO1, VIDEO 2, VIDEO 3, HD1/DVD1/DTV1, or HD2/DVD2/DTV2

■ Multi screen operations may not function depending on the type of the RGB signals.

OSM(On Screen Menu) Controls

Menu Operations

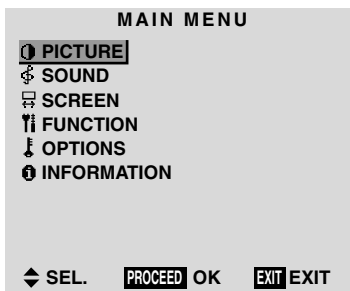
The OSM window is displayed with respect to the screen as shown on the diagram.

- * Depending on the screen's mode, the OSM may be displayed differently.
In the explanation, the OSM section is shown close up.

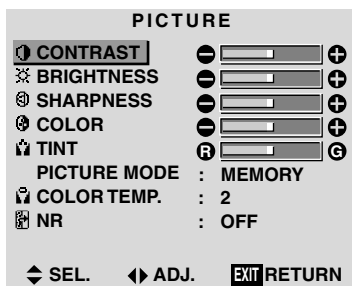


The following describes how to use the menus and the selected items.

1. Press the PROCEED button on the remote control to display the MAIN MENU.



2. Press the cursor buttons ▲ ▼ on the remote control to highlight the menu you wish to enter.
3. Press the PROCEED button on the remote control to select a submenu or item.



4. Adjust the level or change the setting of the selected item by using the cursor buttons ◀ ▶ on the remote control.

5. The change is stored until you adjust it again.
6. Repeat steps 2 – 5 to adjust an additional item, or press the EXIT button on the remote control to return to the main menu.

Note: The main menu disappears by pressing the EXIT button.

Main menu	Sub menu	Functions	Default	Reset
PICTURE	CONTRAST	Adjusts the contrast.	Center	Yes
	BRIGHTNESS	Adjusts the brightness.	Center	Yes
	SHARPNESS	Adjusts the sharpness.	Center	Yes
	COLOR	Adjusts the color.	Center	Yes
	TINT	Adjusts the tint.	Center	Yes
	PICTURE MODE	Sets the picture mode according to the VIDEO environment and image software.	MEMORY	Yes
	COLOR TEMP NR	Adjusts the color temperature and white balance. Reduces noise visible in image.	2*1 OFF	Yes Yes

Main menu	Sub menu	Functions	Default	Reset
SOUND	BASS	Sets the bass.	Center	Yes
	TREBLE	Sets the treble.	Center	Yes
	BALANCE	Sets the left/right balance.	Center	Yes

Main menu	Sub menu	Functions	Default	Reset
SCREEN	V-POSITION	Adjusts the vertical position.	Center	Yes
	H-POSITION	Adjusts the horizontal position.	Center	Yes
	V-HEIGHT	Adjusts the vertical size.	Min	Yes
	H-WIDTH	Adjusts the horizontal size.	Min	Yes
	AUTO PICTURE	Turn this on to have the monitor automatically adjust "FINE PICTURE" and "PICTURE ADJ".	OFF*1	No
	FINE PICTURE PICTURE ADJ.	Adjusts for flickering on the computer image. Adjusts for striped patterns on the computer image.	Min*1 Center*1	Yes Yes

Main menu	Sub menu	Functions	Default	Reset
FUNCTION	OSM	Turns the on-screen menu (screen mode, etc.) off (when set to "OFF"). When set to "ON", the on-screen menu is displayed.	ON	Yes
	OSM ADJ.	Adjusts the vertical and horizontal positions of the menu display.	1	Yes
	POWER MGT	Sets the monitor for use as an energy-saving display when used with a computer.	OFF	Yes
	GRAY LEVEL	In case of 4 : 3, sets the luminance of both sides.	3	Yes
	CINEMA MODE	Sets the picture to suit the movie.	ON	Yes
	RGB3 ADJ.	Adjusts the picture when the picture input from the RGB3 input terminal is distorted.	1	Yes
	LONG LIFE RESET	Sets the picture to reduce burn-in of the display. Resets all the settings (PICTURE, SOUND, SCREEN, FUNCTION, etc.) to the factory default values.	*2 —	Yes —

Main menu	Sub menu	Functions	Default	Reset
OPTION	AUDIO INPUT	Sets the allocation of the audio connectors.	*3	Yes
	BNC SELECT	Sets the BNC connectors.	RGB	Yes
	RGB SELECT	Sets the appropriate mode for the computer image. RGB (VGA signals), VIDEO (Moving picture), WIDE (WIDE VGA) DTV.	AUTO	Yes
	HD SELECT	Sets the digital broadcasting (1080A,1080B) or the High Vision (1035I).	1080B	No
	PICTURE SIZE	Sets the picture size for RGB input.	ON	Yes

Main menu	Sub menu	Functions	Default	Reset
INFORMATION	FREQUENCY	Used to check the frequency and synchronizing polarities of the signal currently being inputted.	—	—
	LANGUAGE	Sets the language of the menus (Japanese, English, German, French, Swedish, Italian or Spanish).	English	No
	COLOR SYSTEM	Sets the VIDEO format (AUTO1, AUTO2, PAL, PAL-M, PAL-N, PAL60, SECAM, 4.43 NTSC or 3.58 NTSC).	AUTO1	No

*1 RGB/PC only.

*2 PLE: AUTO ORBITER: OFF INVERSE: OFF

*3 AUDIO1: VIDEO1 AUDIO2: HD/DVD1 AUDIO3: RGB1

Picture Settings Menu

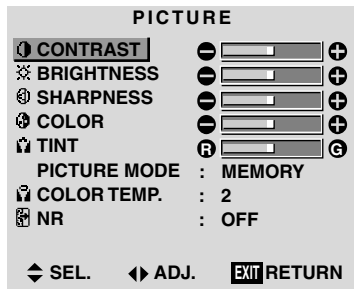
Adjusting the picture

The contrast, brightness, sharpness, color and tint can be adjusted as desired.

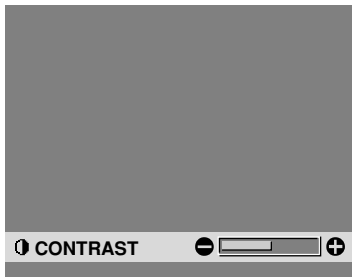
Example: Adjusting the contrast

Press the **PROCEED** button on the remote control to display the **MAIN MENU** on the screen, then...

1. Use the ▲ and ▼ buttons to select “PICTURE”, then press the **PROCEED** button. The “PICTURE” screen appears.
2. Use the ▲ and ▼ buttons to select “CONTRAST”.



3. Use the ◀ and ▶ buttons to adjust the contrast.



* If neither the ◀ or ▶ button is pressed within 5 seconds, the current setting is set and the previous screen reappears.

4. Once the adjustment is completed ...

Press the **EXIT** button to return to the main menu.

To delete the main menu, press the **EXIT** button once more.

Note: If “CAN NOT ADJUST” appears ...
When trying to enter the **PICTURE** submenu, make sure **PICTURE MODE** is set to **MEMORY**.

Information

Picture adjustment screen

CONTRAST Changes the picture’s contrast.
BRIGHTNESS .. Changes the picture’s brightness.
SHARPNESS .. Changes the picture’s sharpness.
Adjusts picture detail of VIDEO display.
COLOR Changes the color density.
TINT Changes the picture’s tint. Adjust for natural colored skin, background, etc.

Adjusting the computer image

Only the contrast and brightness can be adjusted when a computer signal is connected.

Restoring the factory default settings

Select “**RESET**” under the “**PICTURE MODE**” settings.

Setting the picture mode according to the brightness of the room

There are four picture modes that can be used effectively according to the environment in which you are viewing the display.

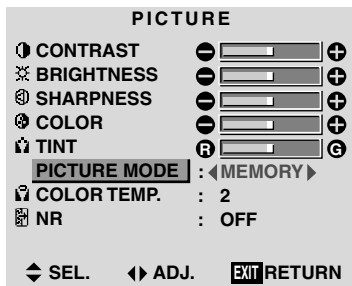
Example: Setting the “THEATER” mode

Press the **PROCEED** button on the remote control to display the **MAIN MENU** on the screen, then...

1. Use the ▲ and ▼ buttons to select “PICTURE”, then press the **PROCEED** button.

The “PICTURE” screen appears.

2. Use the ▲ and ▼ buttons to select “PICTURE MODE”.

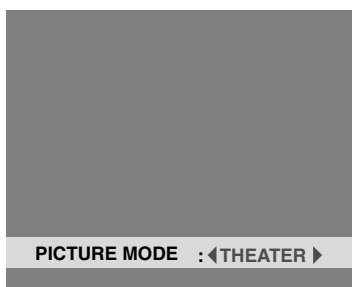


3. To set to “THEATER” ...

Use the ◀ and ▶ buttons to select “THEATER”.

The mode switches as follows when the ◀ and ▶ buttons are pressed:

→ MEMORY ↔ THEATER ↔ NORMAL ↔ RESET ←



* If neither the ◀ or ▶ button is pressed within 5 seconds, the current selection is set and the previous screen reappears.

4. Once the adjustment is completed ...

Press the **EXIT** button to return to the main menu. To delete the main menu, press the **EXIT** button once more.

Information

■ Types of picture modes

MEMORY The last picture adjustments are stored here.

THEATER Set this mode when watching video in a dark room.

This mode provides darker, finer pictures, like the screen in movie theaters.

CONTRAST = 80% for RESET mode
BRIGHTNESS = 95% for RESET mode

NORMAL Set this mode when watching video in a bright room.

This mode provides dynamic pictures with distinct differences between light and dark sections.

CONTRAST = 96% for RESET mode

RESET Use this to reset the picture to the factory default settings.

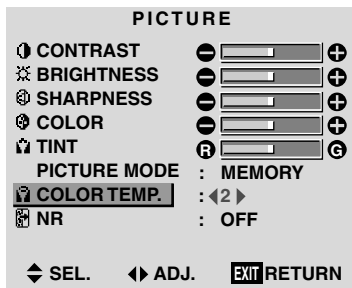
Setting the color temperature

Use this procedure to set color tone produced by the plasma display.

Example: Setting "1"

Press the **PROCEED** button on the remote control to display the **MAIN MENU** on the screen, then...

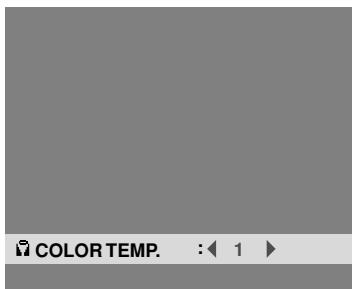
1. Use the ▲ and ▼ buttons to select "PICTURE", then press the **PROCEED** button.
The "PICTURE" screen appears.
2. Use the ▲ and ▼ buttons to select "COLOR TEMP.":



3. Use the ◀ and ▶ buttons to select "1".
The mode switches as follows when the ◀ and ▶ buttons are pressed:

→ 1 ↔ 2 ↔ 3 ↔ PRO ←

* See page E-22 to set "PRO".



* If neither the ◀ or ▶ button is pressed within 5 seconds, the current selection is set and the previous screen reappears.

4. Once the setting is completed...

Press the **EXIT** button to return to the main menu.

To delete the main menu, press the **EXIT** button once more.

Information

■ Setting the color temperature

- 1 High (bluer)
- 2 Middle (Standard)
- 3 Low (redder)

■ Restoring the factory default settings

Select "RESET" under the function menu. Note that this also restores other settings to the factory defaults.

Adjusting the color to the desired quality

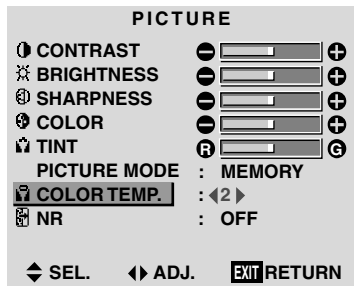
Use this procedure to adjust the white balance for bright pictures and dark pictures to achieve the desired color quality.

Example: Adjusting the “WHITE BALANCE”

Press the *PROCEED* button on the remote control to display the *MAIN MENU* on the screen, then...

1. Use the ▲ and ▼ buttons to select “PICTURE”, then press the *PROCEED* button.
The “PICTURE” screen appears.

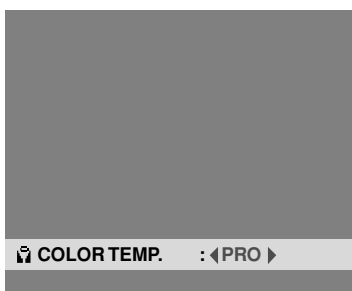
2. Use the ▲ and ▼ buttons to select “COLOR TEMP.”.



3. Use the ◀ and ▶ buttons to select “PRO”.

The mode switches as follows when the ◀ and ▶ buttons are pressed:

→ 1 ↔ 2 ↔ 3 ↔ PRO ←

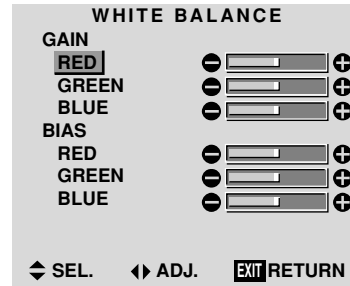


- * If neither the ◀ or ▶ button is pressed within 5 seconds, the current selection is set and the previous screen reappears.

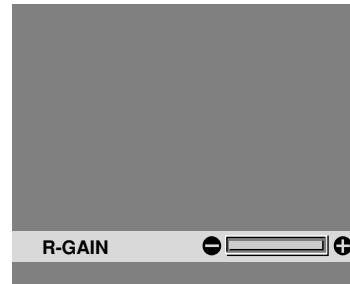
4. Press the *PROCEED* button.

The “WHITE BALANCE” screen appears.

5. Use the ▲ and ▼ buttons to select “RED-GAIN”.



6. Adjust the white balance using the ◀ and ▶ buttons.



- * If neither the ◀ or ▶ button is pressed within 5 seconds, the current setting is set and the previous screen reappears.

7. Once the adjustment is completed...

Press the *EXIT* button to return to the main menu. To delete the main menu, press the *EXIT* button once more.

Information

■ Adjusting the white balance

RGB-GAIN White balance adjustment for signal level

RGB-BIAS White balance adjustment for black level

■ Restoring the factory default settings

Select “RESET” under the function menu. Note that this also restores other settings to the factory defaults.

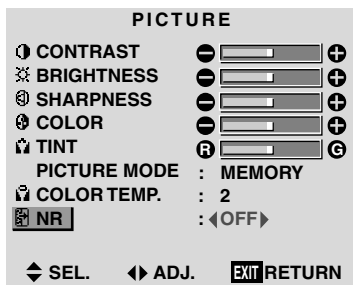
Reducing noise in the picture

Use these settings if the picture has noise due to poor reception or when playing video tapes on which the picture quality is poor.

Example: Setting “NR-3”

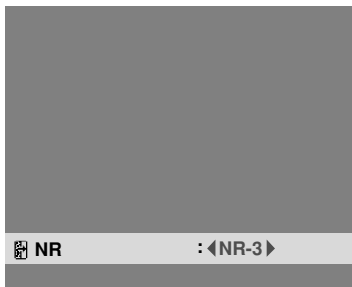
Press the *PROCEED* button on the remote control to display the *MAIN MENU* on the screen, then...

1. Use the ▲ and ▼ buttons to select “PICTURE”, then press the *PROCEED* button.
The “PICTURE” screen appears.
2. Use the ▲ and ▼ buttons to select “NR”.



3. Use the ◀ and ▶ buttons to select “NR-3”.
The mode switches as follows when the ◀ and ▶ buttons are pressed:

→ OFF ↔ NR-1 ↔ NR-2 ↔ NR-3 ←



* If neither the ◀ or ▶ button is pressed within 5 seconds, the current selection is set and the previous screen reappears.

4. *Once the setting is completed ...*

Press the *EXIT* button to return to the main menu.

To delete the main menu, press the *EXIT* button once more.

Information

■ NR

* “NR” stands for Noise Reduction.

* This function reduces noise in the picture.

■ Types of noise reduction

There are three types of noise reduction. Each has a different level of noise reduction.

The effect becomes stronger as the number increases (in the order NR-1 → NR-2 → NR-3).

OFF Turns the noise reduction function off.

Sound Settings Menu

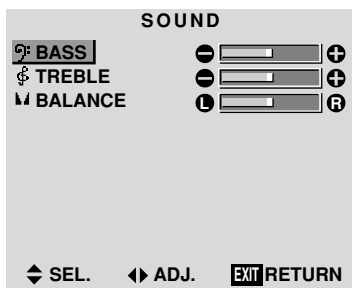
Adjusting the treble, bass and left/right balance

The treble, bass and left/right balance can be adjusted to suit your tastes.

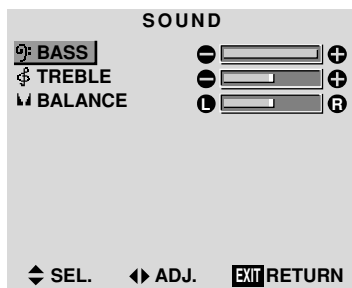
Example: Adjusting the bass

Press the **PROCEED** button on the remote control to display the **MAIN MENU** on the screen, then...

1. Use the ▲ and ▼ buttons to select “**SOUND**”, then press the **PROCEED** button.
The “**SOUND**” screen appears.
2. To adjust the bass ...
Use the ▲ and ▼ buttons to select “**BASS**”.



3. Adjust the bass using the ◀ and ▶ buttons.



* If neither the ◀ or ▶ button is pressed within 5 seconds, the current selection is set and the previous screen reappears.

To continue adjusting the sound ...

Repeat from step 2.

4. Once the adjustment is completed ...

Press the **EXIT** button to return to the main menu. To delete the main menu, press the **EXIT** button once more.

Note: If “**CAN NOT ADJUST**” appears...
Set “**AUDIO INPUT**” on the **OPTION** menu correctly.

Information

■ Sound settings menu

BASS Changes the level of low frequency sound.

TREBLE Changes the level of high frequency sound.

BALANCE Changes the balance of the left and right channels.

■ Restoring the factory default settings

Select “**RESET**” under the function menu. Note that this also restores other settings to the factory defaults.

Screen Settings Menu

Adjusting the Position, Size, Fine Picture, Picture Adj

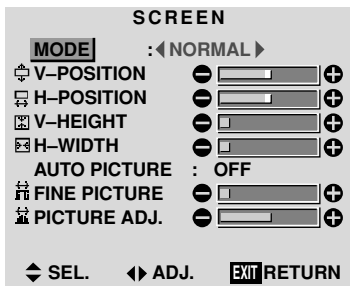
The position of the image can be adjusted and flickering of the image can be corrected.

Example: Adjusting the vertical position in the normal mode

Press the *PROCEED* button on the remote control to display the *MAIN MENU* on the screen, then...

1. Use the ▲ and ▼ buttons to select “SCREEN”, then press the *PROCEED* button. The “SCREEN” menu appears.

Default settings (when RGB/PC is selected)



* The settings on the SCREEN menu are not preset at the factory.

To select a mode ...

Use the ◀ and ▶ buttons to select a mode.

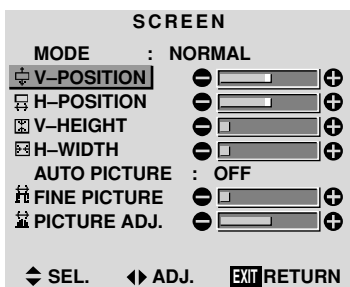
The mode switches as follows when the ◀ and ▶ buttons are pressed:

→ NORMAL ↔ FULL ←

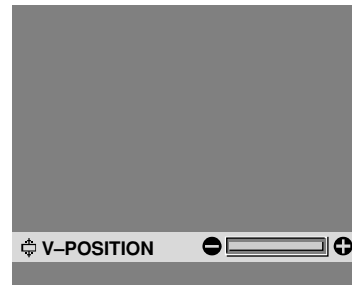
* The mode can also be switched by pressing the “WIDE” button on the remote control.

2. To adjust the vertical position ...

Use the ▲ and ▼ buttons to select “V-POSITION”.



3. Adjust using the ◀ and ▶ buttons.



* If neither the ◀ or ▶ button is pressed within 5 seconds, the current setting is set and the previous screen reappears.

To continue making other computer image adjustments ...

Repeat from step 2.

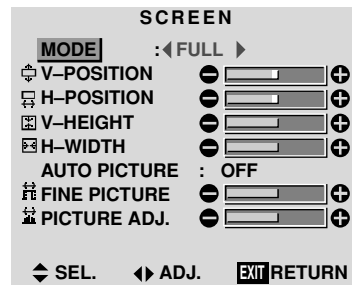
4. Once all adjustments are completed ...

Press the *EXIT* button to return to the main menu.

To delete the main menu, press the *EXIT* button once more.

Information

■ When “AUTO PICTURE” is “OFF”



When Auto Picture is off, the Fine Picture and the Picture ADJ items are displayed so that you can adjust them.

Information

■ Adjusting the Auto Picture

ON The Picture ADJ and Fine Picture adjustments are made automatically.

OFF The Picture ADJ and Fine Picture adjustments are made manually.

■ Adjusting the position of the image

V-POSITION ... Adjusts the vertical position of the image.

H-POSITION ... Adjusts the horizontal position of the image.

V-HEIGHT Adjusts the vertical size of the image. (Except for STADIUM mode)

H-WIDTH Adjusts the horizontal size of the image. (Except for STADIUM mode)

FINE PICTURE* .. Adjusts for flickering.

PICTURE ADJ* Adjusts for striped patterns on the image.

* The Picture ADJ and Fine Picture features are available only when the "Auto Picture" is off.

* The AUTO PICTURE, FINE PICTURE and PICTURE ADJ. are not available for VIDEO and HD/DVD source.

■ Restoring the factory default settings

Select "RESET" under the function menu. Note that this also restores other settings to the factory defaults except for Auto Picture.

Function Settings Menu

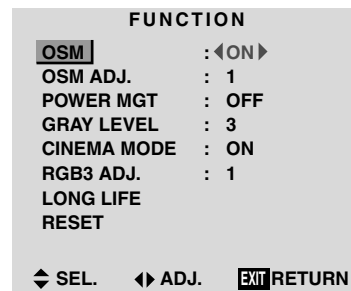
Setting the on-screen menu

When using the monitor for presentations, etc., the monitor can be set so that the input source, screen mode, etc., do not appear.

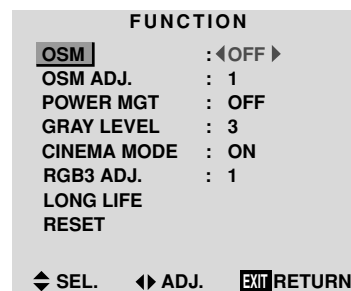
Example: Turning the on-screen menu mode off

Press the *PROCEED* button on the remote control to display the *MAIN MENU* on the screen, then...

1. Use the ▲ and ▼ buttons to select "FUNCTION", then press the *PROCEED* button. The "FUNCTION" screen appears.
2. Use the ▲ and ▼ buttons to select "OSM".



3. To turn the on-screen menu mode off... Use the ◀ and ▶ buttons to select "OFF". The mode switches as follows each time the ◀ or ▶ button is pressed:
ON ↔ OFF



4. Once the setting is completed ... Press the *EXIT* button to return to the main menu. To delete the main menu, press the *EXIT* button once more.

Information

■ OSM modes

ON The on-screen menu appears.

OFF The on-screen menu does not appear.

■ Restoring the factory default settings

Select "RESET" under the function menu. Note that this also restores other settings to the factory defaults.

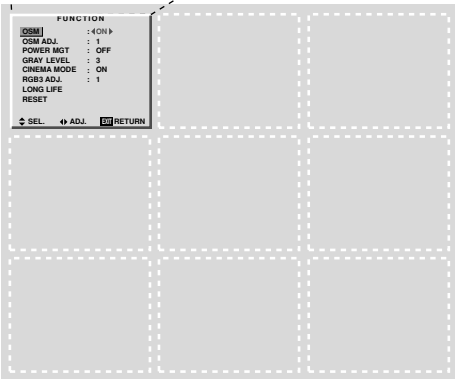
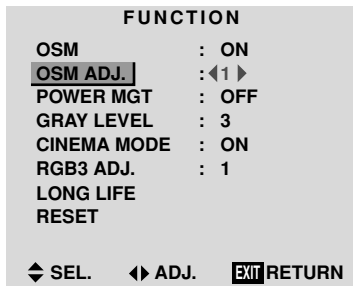
Adjusting the position of the menu display

Use these operations to adjust the position of the menus that appear on the screen.

Example: Adjusting the position of the menu display

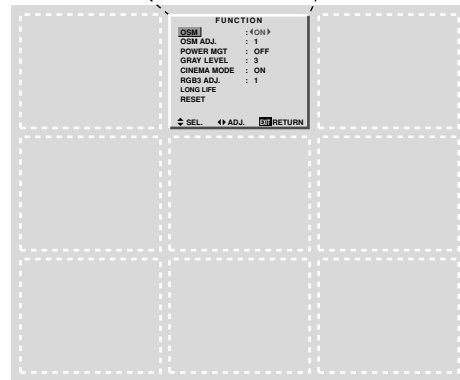
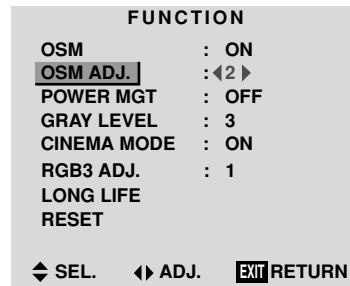
Press the *PROCEED* button on the remote control to display the *MAIN MENU* on the screen, then...

1. Use the ▲ and ▼ buttons to select “FUNCTION”, then press the *PROCEED* button. The “FUNCTION” menu appears.
2. Use the ▲ and ▼ buttons to select “OSM ADJ.”



3. To adjust the position...

Adjust using the ◀ and ▶ buttons.



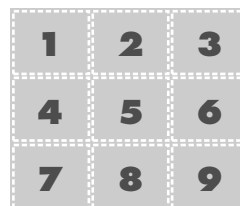
4. Once all adjustments are completed ...

Press the *EXIT* button to return to the main menu.

To delete the main menu, press the *EXIT* button once more.

Information

■ Adjusting the position of the menu display



The position can be set between 1 and 9.

■ Restoring the factory default settings

Select “RESET” under the function menu. Note that this also restores other settings to the factory defaults.

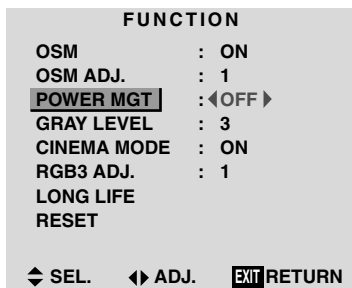
Setting the power management for computer images

This energy-saving (power management) function automatically reduces the monitor's power consumption if no operation is performed for a certain amount of time.

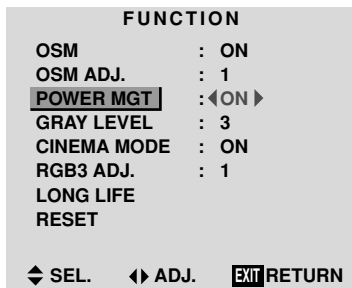
Example: Turning the power management function on

Press the **PROCEED** button on the remote control to display the **MAIN MENU** on the screen, then...

1. Use the ▲ and ▼ buttons to select "FUNCTION", then press the **PROCEED** button.
The "FUNCTION" screen appears.
2. Use the ▲ and ▼ buttons to select "POWER MGT".



3. To turn the power management function on ...
Use the ◀ and ▶ buttons to select "ON".
The mode switches as follows each time the ◀ or ▶ button is pressed:
ON ↔ OFF



4. Once the setting is completed ...
Press the **EXIT** button to return to the main menu.
To delete the main menu, press the **EXIT** button once more.

Information

■ Power management function

- * The power management function automatically reduces the monitor's power consumption if the computer's keyboard or mouse is not operated for a certain amount of time. This function can be used when using the monitor with a computer conforming to the VESA DPMS format.
- * If the computer's power is not turned on or if the computer and selector tuner are not properly connected, the system is set to the off state.
- * For instructions on using the computer's power management function, refer to the computer's operating instructions.

■ Power management settings

- ON In this mode the power management function is turned on.
- OFF In this mode the power management function is turned off.

■ Power management function and POWER/STANDBY indicator

The POWER/STANDBY indicator indicates the status of the power management function. See page E-29 for indicator status and description.

■ Restoring the factory default settings

Select "RESET" under the function menu. Note that this also restores other settings to the factory defaults.

POWER/STANDBY indicator

Power management mode	POWER/STANDBY indicator	Power management operating status	Description	Turning the picture back on
On	Green	Not activated.	Horizontal and vertical synchronizing signals are present from the computer.	Picture already on.
Standby	Orange	Activated.	No horizontal synchronizing signals are sent from the computer.	Operate the keyboard or mouse. The picture reappears immediately.
Suspend	Red	Activated.	No vertical synchronizing signals are sent from the computer.	Operate the keyboard or mouse. The picture reappears, but more time is required than from the standby mode.
Off	Red	Activated.	No horizontal or vertical synchronizing signals are sent from the computer.	Operate the keyboard or mouse. The picture reappears, but more time is required than from the standby mode or suspend mode.

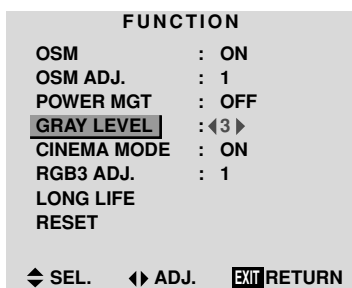
Setting the gray level for the sides of the screen

Use this procedure to set the gray level for the parts on the screen on which nothing is displayed when the screen is set to the 4:3 size.

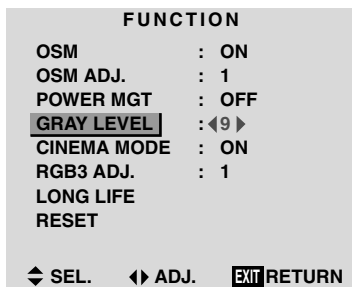
Example: Adjusting the “GRAY LEVEL”

Press the *PROCEED* button on the remote control to display the *MAIN MENU* on the screen, then...

1. Use the ▲ and ▼ buttons to select “FUNCTION”, then press the *PROCEED* button.
The “FUNCTION” screen appears.
2. Use the ▲ and ▼ buttons to select “GRAY LEVEL”.



3. To adjust the “GRAY LEVEL”...
Use the ◀ and ▶ buttons to adjust the GRAY LEVEL.



4. Once the setting is completed ...
Press the *EXIT* button to return to the main menu.
To delete the main menu, press the *EXIT* button once more.

Information

■ GRAY LEVEL

This adjusts the brightness of the black (the gray level) for the sides of the screen.
The standard is 0 (black). The level can be adjusted from 0 to 15. The factory setting is 3 (dark gray).

■ Restoring the factory default settings

Select “RESET” under the function menu. Note that this also restores other settings to the factory defaults.

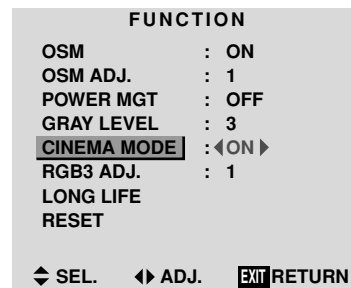
Setting the picture to suit the movie

The film image is automatically discriminated and projected in an image mode suited to the picture.
[NTSC, 480I (60Hz), 1035I (60Hz), 1080I (60Hz) only]

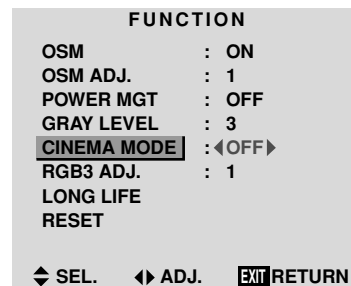
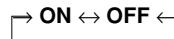
Example: Setting the “CINEMA MODE” to “OFF”

Press the *PROCEED* button on the remote control unit to display the *MAIN MENU* on the screen, then...

1. Use the ▲ and ▼ buttons to select “FUNCTION”, then press the *PROCEED* button.
The “FUNCTION” screen appears.
2. Use the ▲ and ▼ buttons to select “CINEMA MODE”.



3. To set the *CINEMA MODE* to “OFF” ...
Use the ◀ and ▶ buttons to select “OFF”.
The mode switches as follows each time the ◀ or ▶ button is pressed:



4. Once the setting is completed ...
Press the *EXIT* button to return to the main menu.
To delete the main menu, press the *EXIT* button once more.

Information

■ CINEMA MODE

ON Automatic discrimination of the image and projection in cinema mode.
OFF Cinema mode does not function.

■ Restoring the factory default settings

Select “RESET” under the function menu. Note that this also restores other settings to the factory defaults.

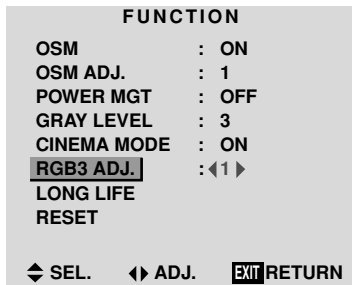
Setting RGB3 ADJ.

When the picture input from the RGB3 input terminal is distorted, select the most appropriate setting from among “1”, “2”, and “3”.

Example: Setting “2”

Press the **PROCEED** button on the remote control to display **MAIN MENU** on the screen, then...

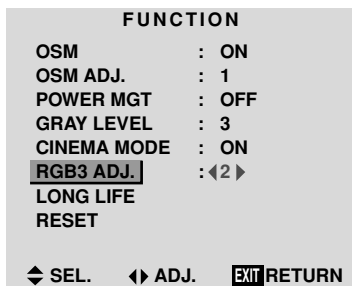
1. Use the ▲ and ▼ buttons to select “FUNCTION”, then press the **PROCEED** button.
The “FUNCTION” screen appears.
2. Use the ▲ and ▼ buttons to select “RGB3 ADJ.”.



3. To select “2”...

Use the ◀ and ▶ buttons to select “2”.
The mode switches as follows each time the ◀ or ▶ button is pressed:

→ 1 ↔ 2 ↔ 3 ←



4. Once the setting is completed...

Press the **EXIT** button to return to the main menu.
To delete the main menu, press the **EXIT** button once more.

Information

■ When you adjust the RGB3 ADJ.

The position of the menu display will change. In such a case, be sure to adjust the position.

■ Restoring the factory default settings

Select “RESET” under the function menu. Note that this also restores other settings to the factory defaults.

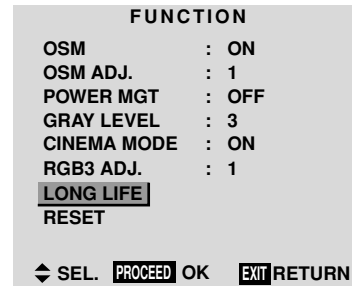
Reducing burn-in of the screen

The brightness of the screen, the position of the picture, and positive/negative mode are adjusted to reduce burn-in of the screen.

Example: Setting “PLE” to “LOCK”

Press the **PROCEED** button on the remote control to display the **MAIN MENU** on the screen, then proceed as follows.

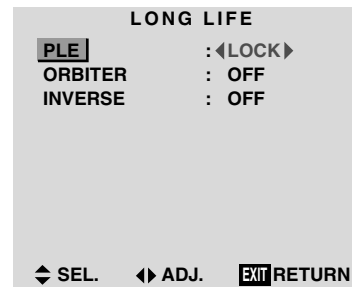
1. Use the ▲ and ▼ buttons to select “FUNCTION”, then press the **PROCEED** button.
The “FUNCTION” screen appears.
2. Use the ▲ and ▼ buttons to select “LONG LIFE”, then press the **PROCEED** button.



The “LONG LIFE” screen appears.

3. Use the ▲ and ▼ buttons to select “PLE”, then use the ◀ and ▶ buttons to select “LOCK”.
The mode switch changes as follows each time the ◀ or ▶ button is pressed:

AUTO ↔ LOCK



4. Once the setting is completed...

Press the **EXIT** button to return to the **FUNCTION** menu.

To exit the main menu, press the **EXIT** button twice.

Information

■ PLE

AUTO The brightness of the screen is adjusted automatically to suit the picture quality.

LOCK The brightness level is set to minimum.

■ ORBITER

ON The picture moves around the screen intermittently.

OFF Orbiter mode does not function.

■ INVERSE

ON The picture is displayed alternately between positive image and negative image.

OFF Inverse mode does not function.

WT The entire screen turns white.

■ Restoring the factory default settings

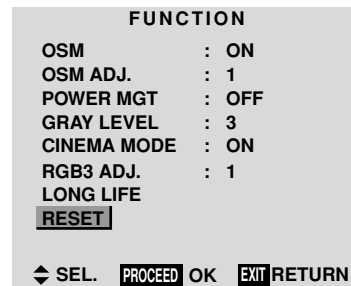
Select "RESET" from the function menu. Note that this also restores other settings to the factory defaults.

Resetting to the default values

Use these operations to restore all the picture adjustments, audio settings, to the factory default values. Refer to page E-18 for items to be reset.

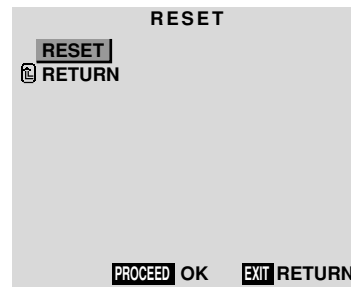
Press the PROCEED button on the remote control to display the MAIN MENU on the screen, then...

1. Use the ▲ and ▼ buttons to select "FUNCTION", then press the PROCEED button. The "FUNCTION" screen appears.
2. Use the ▲ and ▼ buttons to select "RESET", then press the PROCEED button.



The "RESET" screen appears.

3. Use the ▲ and ▼ buttons to select "RESET", then press the PROCEED button.



When the "SETTING NOW" screen disappears, the screen will be restored to the previous "RESET" mode, then all the settings are restored to the default values.

4. *Once the setting is completed ...*
Press the EXIT button.
To delete the main menu, press the EXIT button once more.

Option Settings Menu

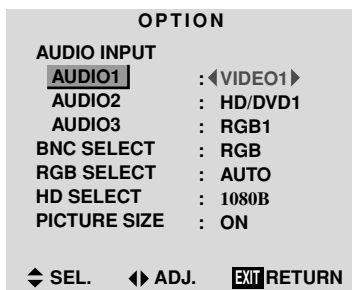
Setting the allocation of the audio connectors

Setting the AUDIO 1, 2, and 3 connectors to the desired input.

Example: Setting "AUDIO 1" to "VIDEO 2"

Press the **PROCEED** button on the remote control to display the **MAIN MENU** on the screen, then...

1. Use the ▲ and ▼ buttons to select "OPTION", then press the **PROCEED** button.
The "OPTION" screen appears.
2. Use the ▲ and ▼ buttons to select "AUDIO 1".



3. To set the **AUDIO1** to "VIDEO2"...
Use the ◀ and ▶ buttons to select "VIDEO2".
The mode switches as follows each time the ◀ or ▶ button is pressed:

→ VIDEO1 ↔ VIDEO2 ↔ VIDEO3 ↔ HD/DVD1 ↔ RGB/PC1 ↔ RGB/PC2 ↔ RGB/PC3 ←



4. Once the setting is completed...
Press the **EXIT** button to return to the main menu.
To delete the main menu, press the **EXIT** button once more.

Information

■ AUDIO INPUT

A single audio input cannot be selected as the audio channel for more than one input terminal.

■ Restoring the factory default settings

Select "RESET" under the function menu. Note that this also restores other settings to the factory defaults.

Setting the BNC connectors

Select whether to set the input of the 5 BNC connectors to RGB or component.

Example: Set the BNC SELECT mode to "COMP."

Press the **PROCEED** button on the remote control to display the **MAIN MENU** on the screen, then...

1. Use the ▲ and ▼ buttons to select "OPTION", then press the **PROCEED** button.
The "OPTION" screen appears.
2. Use the ▲ and ▼ buttons to select "BNC SELECT".



3. To set the **BNC SELECT** mode to "COMP."...
Use the ◀ and ▶ buttons to select "COMP.".
The mode switches as follows each time the ◀ or ▶ button is pressed:

→ RGB ↔ COMP. ↔ SCART ←



4. Once the setting is completed...
Press the **EXIT** button to return to the main menu.
To delete the main menu, press the **EXIT** button once more.

Information

■ BNC SELECT

RGB Uses the 5BNC terminal for RGB input.

COMP. Use the 3BNC terminal for component input.

SCART Use the 4BNC terminal for RGB with composite sync input. See page E-8.

■ Restoring the factory default settings

Select "RESET" under the function menu. Note that this also restores other settings to the factory defaults.

Setting a computer image to the correct RGB select screen

With the computer image, select the RGB Select mode for a moving image such as (video) mode, wide mode or digital broadcast.

Example: Setting the "RGB SELECT" mode to "MOTION"

Press the *PROCEED* button on the remote control to display the *MAIN MENU* on the screen, then...

1. Use the ▲ and ▼ buttons to select "OPTION", then press the *PROCEED* button.
The "OPTION" screen appears.
2. Use the ▲ and ▼ buttons to select "RGB SELECT".



3. To set the RGB select mode to "MOTION" ...
Use the ◀ and ▶ buttons to select "MOTION".
The mode switches as follows each time the ◀ or ▶ button is pressed:

→ AUTO ↔ STILL ↔ MOTION ↔ WIDE1 ↔ WIDE2 ↔ DTV ←



4. Once the setting is completed ...
Press the *EXIT* button to return to the main menu.
To delete the main menu, press the *EXIT* button once more.

Information

■ RGB SELECT modes

One of these 6 modes must be selected in order to display the following signals correctly.

AUTO Select the suitable mode for the specifications of input signals as listed in the table "Computer input signals supported by this system" on page E-47.

STILL To display VESA standard signals. (Use this mode for a still image from a computer.)

MOTION The video signal (from a scan converter) will be converted to RGB signals to make the picture more easily viewable. (Use this mode for a motion image from a computer.)

WIDE1 When an 852 dot × 480 line signal with a horizontal frequency of 31.7kHz is input, the image may be compressed horizontally. To prevent this, set RGB SELECT to WIDE1.

WIDE2 When an 848 dot × 480 line signal with a horizontal frequency of 31.0 kHz is input, the image may be compressed horizontally. To prevent this, set RGB SELECT to WIDE2.

DTV Set this mode when watching digital broadcasting (480P).

See page E-47 for the details of the above settings.

■ Restoring the factory default settings

Select "RESET" under the function menu. Note that this also restores other settings to the factory defaults.

Setting high definition images to the suitable screen size

Use this procedure to set whether the number of vertical lines of the input high definition image is 1035 or 1080.

Example: Setting the "1080B" mode to "1035I"

Press the **PROCEED** button on the remote control to display the **MAIN MENU** on the screen, then...

1. Use the ▲ and ▼ buttons to select "OPTION", then press the **PROCEED** button.
The "OPTION" screen appears.
2. Use the ▲ and ▼ buttons to select "HD SELECT".



3. To set the **HD SELECT** mode to "1035I" ...
Use the ◀ and ▶ buttons to select "1035I".
The mode switches as follows each time the ◀ or ▶ button is pressed:

→1080A ↔ 1080B ↔ 1035I ←



4. Once the setting is completed ...
Press the **EXIT** button to return to the main menu.
To delete the main menu, press the **EXIT** button once more.

Information

■ HD SELECT modes

These 3 modes are not displayed in correct image automatically.

1080A Special Digital broadcasts (for example : DTC100)

1080B Standard digital broadcasts

1035I Japanese "High Vision" signal format

Setting the picture size for RGB input signals

Use this procedure to switch the setting to “ON” or “OFF”.

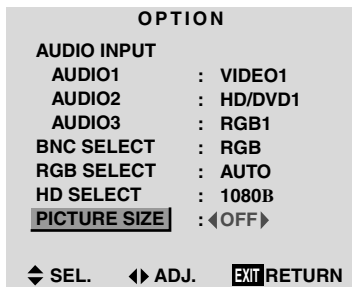
Example: Setting the “ON” mode to “OFF”

Press the *PROCEED* button on the remote control to display the *MAIN MENU* on the screen, then...

1. Use the ▲ and ▼ buttons to select “OPTION”, then press the *PROCEED* button.
The “OPTION” screen appears.
2. Use the ▲ and ▼ buttons to select “PICTURE SIZE”.



3. To set *PICTURE SIZE* mode to “OFF”...
Use the ◀ and ▶ buttons to select “OFF”.
The mode switches as follows when the ◀ or ▶ buttons are pressed:
ON ↔ OFF



4. Once the setting is completed ...
Press the *EXIT* button to return to the main menu.
To delete the main menu, press the *EXIT* button once more.

Information

■ PICTURE SIZE

ON For RGB Input: “NORMAL” and “FULL” can be selected for Wide-Screen switching.

OFF For RGB Input: “TRUE” and “FULL” can be selected for Wide-Screen switching.

■ Restoring the factory default settings

Select “RESET” under the function menu. Note that this also restores other settings to the factory defaults.

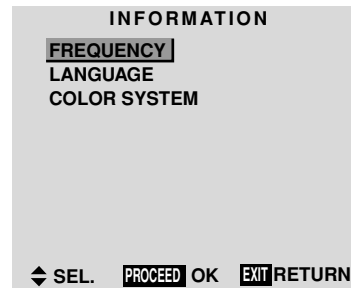
Information Menu

Checking the frequencies, polarities of input signals, and resolution

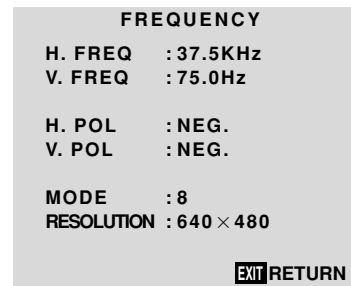
Use this function to check the frequencies and polarities of the signals currently being input from a computer, etc.

Press the *PROCEED* button on the remote control to display the *MAIN MENU* on the screen, then...

1. Use the ▲ and ▼ buttons to select “INFORMATION”, then press the *PROCEED* button.
The “INFORMATION” screen appears.
2. Use the ▲ and ▼ buttons to select “FREQUENCY”, then press the *PROCEED* button.



3. The frequency is displayed.



* Press the *EXIT* button to return to the previous screen.

4. Once you have checked the frequency ...
Press the *EXIT* button to return to the main menu.
To delete the main menu, press the *EXIT* button once more.

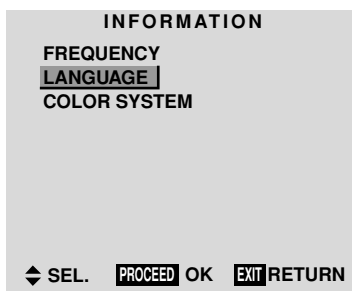
Setting the language for the menus

The menu display can be set to one of seven languages: Japanese, English, German, French, Swedish, Italian or Spanish.

Example: Setting the menu display to “DEUTSCH”

Press the *PROCEED* button on the remote control to display the *MAIN MENU* on the screen, then...

1. Use the ▲ and ▼ buttons to select “INFORMATION”, then press the *PROCEED* button. The “INFORMATION” screen appears.
2. Use the ▲ and ▼ buttons to select “LANGUAGE”, then press the *PROCEED* button.



The “LANGUAGE” screen appears.

3. To select “DEUTSCH” ...
Use the ◀ and ▶ buttons to select “DEUTSCH”.
The mode switches as follows when the ◀ and ▶ buttons are pressed:

→ ENGLISH ↔ DEUTSCH ↔ FRANÇAIS ←
→ 日本語 ↔ SVENSKA ↔ ITALIANO ↔ ESPAÑOL ←



4. Press the *PROCEED* button.
The display language is switched to Deutsch.
5. Once the setting is completed ...
Press the *EXIT* button to return to the main menu.
To delete the main menu, press the *EXIT* button once more.

Information

■ Language settings

ENGLISH English
DEUTSCH German
FRANÇAIS French
ESPAÑOL Spanish
ITALIANO Italian
SVENSKA Swedish
日本語 Japanese

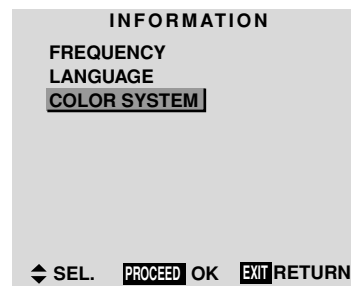
Setting the video signal format

Use these operations to set the video signal format.

Example: Setting the video signal format to “3.58 NTSC”

Press the *PROCEED* button on the remote control to display the *MAIN MENU* on the screen, then...

1. Use the ▲ and ▼ buttons to select “INFORMATION”, then press the *PROCEED* button.
The “INFORMATION” screen appears.
2. Use the ▲ and ▼ buttons to select “COLOR SYSTEM”, then press the *PROCEED* button.



The “COLOR SYSTEM” screen appears.



3. To select “3.58 NTSC” ...
Use the ◀ and ▶ buttons to select “3.58 NTSC”.
The mode switches as follows when the ◀ and ▶ buttons are pressed:

→ AUTO1 ↔ AUTO2 ↔ 3.58NTSC ↔ 4.43NTSC ←
→ SECAM ↔ PAL-M ↔ PAL-N ↔ PAL60 ↔ PAL ←



4. *Once the setting is completed ...*

Press the EXIT button to return to the main menu.
To delete the main menu, press the EXIT button once more.

The color system is set to “3.58 NTSC”.

Information

■ **Video signal formats**

Different countries use different formats for video signals. Set to the format used in your current country.

AUTO1/2 The video signals are automatically detected and the format is set accordingly.

AUTO1: 3.58NTSC, 4.43NTSC, PAL, SECAM, PAL60

AUTO2: PAL-M, PAL-N, 3.58NTSC

PAL (B, G) This is the standard format used mainly in the United Kingdom and Germany.

SECAM..... This is the standard format used mainly in France and Russia.

4.43 NTSC,

PAL60 This format is used for videos in countries using PAL and SECAM video signals.

3.58 NTSC This is the standard format used mainly in Japan and the United States.

PAL-M This is the standard format used mainly in Brazil.

PAL-N This is the standard format used mainly in Argentina.

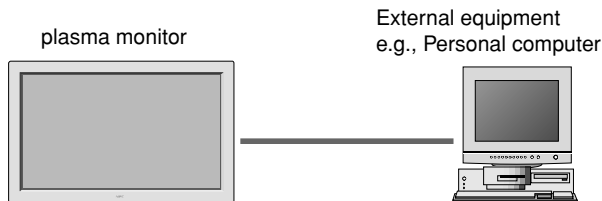
External Control

Application

These specifications cover the communications control of the plasma monitor by external equipment.

Connections

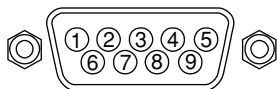
Connections are made as described below.



- 1) Connector on the plasma monitor side: EXTERNAL CONTROL connector.

Type of connector: D-Sub 9-pin male

No.	Pin Name
1	No Connection
2	RXD (Receive data)
3	TXD (Transmit data)
4	DTR (DTE side ready)
5	GND
6	DSR (DCE side ready)
7	RTS (Ready to send)
8	CTS (Clear to send)
9	No Connection



- 2) Connector on the external equipment side: Serial port (RS-232C) connector.

See the specifications of the equipment that is to be connected for the type of connector and the pin assignment.

- 3) Wiring

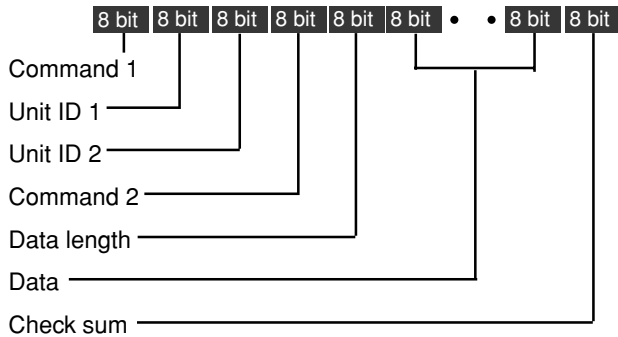
Use a crossed (reverse) cable.

Wire the cable so that each pair of data lines cross between the two devices. These data line pairs are RXD (Receive data) and TXD (Transmit data), DTR (DTE side ready) and DSR (DCE side ready), and RTS (Ready to send) and CTS (Clear to send).

Communication Parameters

- | | |
|--------------------------|--------------|
| (1) Communication system | Asynchronous |
| (2) Interface | RS-232C |
| (3) Baud rate | 9600 bps |
| (4) Data length | 8 bits |
| (5) Parity | Odd |
| (6) Stop bit | 1 bit |
| (7) Communication code | Hex |

Communication Format



Command 1

Command 1, along with command 2, is a number used to distinguish each command.

In the case of ACK, when the lower order 4 bits is FH (as in 3FH and 7FH), this indicates that the commands and data of the supported equipment have been received. When the lower order 4 bits is BH (as in 3BH and 7BH), this indicates that unsupported commands and data have been received.

Unit ID 1 and Unit ID 2

Unit ID 1 and unit ID 2 are numbers used to identify the equipment that is to be connected.

60H is used for the plasma monitor and 80H is used for external control equipment such as a personal computer.

- 1) Unit ID 1: Indicates the equipment sending the signal
- 2) Unit ID 2: Indicates the equipment receiving the signal

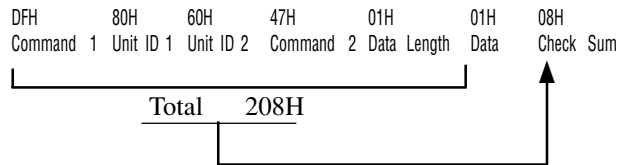
Command 2

Command 2, along with command 1, is a number used to distinguish each command.

Check Sum (CKS), Error Processing, and ACK

- 1) The check sum described below and RS-232C odd parity are used together for a check of the received data. The check sum is the lower order 8 bits of one frame of sent or received data comprising the sum total of Command 1, Unit ID 1 and 2, Command 2, Data Length, and Data.

Check Sum Example



2) Error Processing

- When the communication interval is vacant for more than 4 ms, thereafter a received Command 1 will be recognized. If, at this time, meaningful data cannot be recognized, that data will not be recognized (as valid data).
- An ACK will not be returned unless the receive data error, the check sum error, and the receive data are all taken in.

Command Reference List

	CMD1	CMD2	LEN
01. Power ON	9FH	4EH	00H
02. Power OFF	9FH	4FH	00H
03. Input Switch Change	DFH	47H	01H
04. VOLUME Gain Data	DFH	7FH	03H
05. SCREEN MODE Select	DFH	51H	01H
06. AUDIO Mute On	9FH	3EH	00H
07. AUDIO Mute Off	9FH	3FH	00H
08. OSM Select	DFH	58H	01H
09. Color Gain Data	DFH	7FH	03H
10. TINT Gain Data	DFH	7FH	03H
11. SHARPNESS Gain Data	DFH	7FH	03H
12. CONTRAST Gain Data	DFH	7FH	03H
13. BRIGHT Gain Data	DFH	7FH	03H
14. Input MODE Request	1FH	41H	00H
15. RESET	1FH	54H	00H
16. COLOR TEMP SELECT	DFH	00H	01H
17. RED Gain Data	DFH	7FH	04H
18. GREEN Gain Data	DFH	7FH	04H
19. BLUE Gain Data	DFH	7FH	04H
20. Multi Screen Select	DFH	07H	01H
21. VIDEO ADJ Request	1FH	45H	00H
22. Audio Select Set	DFH	70H	02H
23. Audio Select Request	1FH	6FH	00H
24. LONG LIFE Set	DFH	6BH	03H
25. Failure Mode Request	1FH	3FH	00H

01. Power ON

Function

The external control equipment switches on the power of the plasma monitor.

Transmission Data

9FH	80H	60H	4EH	00H	CKS
-----	-----	-----	-----	-----	-----

ACK

The plasma monitor returns the following ACK when the power is switched on.

3FH	60H	80H	4EH	00H	CKS
-----	-----	-----	-----	-----	-----

NOTE: Do not set the Power ON or Power OFF command continuously.

02. Power OFF

Function

The external control equipment switches off the power of the plasma monitor.

Transmission Data

9FH	80H	60H	4FH	00H	CKS
-----	-----	-----	-----	-----	-----

ACK

The plasma monitor returns the following ACK when the power is switched off.

3FH	60H	80H	4FH	00H	CKS
-----	-----	-----	-----	-----	-----

NOTE: Do not set the Power ON or Power OFF command continuously.

03. Input Switch Change

Function

The external control equipment switches the input of the plasma monitor.

Transmission Data

DFH	80H	60H	47H	01H	DATA00	CKS
DATA00	: Input Select					
			01H: Video1			
			02H: Video2			
			03H: Video3			
			05H: HD (HD1 or DTV or DTV1)			
			06H: HD2 (DTV2)			
			07H: RGB1/PC1			
			08H: RGB2/PC2			
			0CH: RGB3/PC3			

ACK

The plasma monitor returns the following ACK when the input is switched.

3FH	60H	80H	47H	00H	CKS
-----	-----	-----	-----	-----	-----

04. VOLUME Gain Data

Function

The external control equipment changes the VOLUME gain data of the plasma monitor.

Transmission Data

DFH	80H	60H	7FH	03H	DATA00	DATA01	DATA02	CKS
DATA00	USER SOUND Gain Flag				05H			
DATA01	VOLUME Gain Flag				01H			
DATA02	VOLUME Gain				00H: Step 0			
					0AH: Step 10 (Default)			
					2AH: Step 42			

ACK

7FH	60H	80H	7FH	02H	DATA00	DATA01	CKS
-----	-----	-----	-----	-----	--------	--------	-----

DATA00	USER SOUND Gain Flag				05H		
--------	----------------------	--	--	--	-----	--	--

DATA01	VOLUME Gain Flag				01H		
--------	------------------	--	--	--	-----	--	--

05. SCREEN MODE Select

Function

The external control equipment switches the screen mode of the plasma monitor.

Transmission Data

DFH	80H	60H	51H	01H	DATA00	CKS
-----	-----	-----	-----	-----	--------	-----

DATA00	02H : STADIUM					
	03H : ZOOM					
	04H : NORMAL					
	05H : FULL					
	06H : TRUE (REAL)					

ACK

7FH	60H	80H	51H	01H	DATA00	CKS
-----	-----	-----	-----	-----	--------	-----

DATA00	02H : STADIUM					
	03H : ZOOM					
	04H : NORMAL					
	05H : FULL					
	06H : TRUE (REAL)					

06. AUDIO Mute On

Function

The external control equipment switches on AUDIO Mute of the plasma monitor.

Transmission Data

9FH	80H	60H	3EH	00H	CKS
-----	-----	-----	-----	-----	-----

ACK

3FH	60H	80H	3EH	00H	CKS
-----	-----	-----	-----	-----	-----

07. AUDIO Mute Off

Function

The external control equipment switches off AUDIO Mute of the plasma monitor.

Transmission Data

9FH	80H	60H	3FH	00H	CKS
-----	-----	-----	-----	-----	-----

ACK

3FH	60H	80H	3FH	00H	CKS
-----	-----	-----	-----	-----	-----

08. OSM Select

Function

The external control equipment switches on or off the on-screen menu (OSM) of the plasma monitor.

Transmission Data

DFH	80H	60H	58H	01H	DATA00	CKS
-----	-----	-----	-----	-----	--------	-----

DATA00 01H : On-Screen menu On
02H : On-Screen menu Off

ACK

7FH	60H	80H	58H	01H	DATA00	CKS
-----	-----	-----	-----	-----	--------	-----

DATA00 01H : On-Screen menu On
02H : On-Screen menu Off

On-Screen menu On/Off is equivalent to the On-Screen menu On/Off function of the convenient function settings.

*Operation is as described in the table below.

09. COLOR Gain Data

Function

The external control equipment changes the COLOR gain data of the plasma monitor.

Transmission Data

DFH	80H	60H	7FH	03H	DATA00	DATA01	DATA02	CKS
-----	-----	-----	-----	-----	--------	--------	--------	-----

DATA00: USER PICTURE Gain Flag	01H
DATA01: COLOR Gain Flag	04H
DATA02: COLOR Gain	E0H: -32
* COLOR Gain is from -22 (EAH) to +22 (16H) only during video.	
	FFH: -01
	00H: 0
	01H: +01
	20H: +32

ACK

7FH	60H	80H	7FH	02H	DATA00	DATA01	CKS
-----	-----	-----	-----	-----	--------	--------	-----

DATA00: USER PICTURE Gain Flag	01H
DATA01: COLOR Gain Flag	04H

10. TINT Gain Data

Function

The external control equipment changes the TINT gain data of the plasma monitor.

Transmission Data

DFH	80H	60H	7FH	03H	DATA00	DATA01	DATA02	CKS
-----	-----	-----	-----	-----	--------	--------	--------	-----

DATA00: USER PICTURE Gain Flag	01H
DATA01: TINT Gain Flag	05H
DATA02: TINT Gain	E0H: -32
* TINT Gain is from -22 (EAH) to +22 (16H) only during video.	
	FFH: -01
	00H: 0
	01H: +01
	20H: +32

ACK

7FH	60H	80H	7FH	02H	DATA00	DATA01	CKS
-----	-----	-----	-----	-----	--------	--------	-----

DATA00: USER PICTURE Gain Flag	01H
DATA01: TINT Gain Flag	05H

Operation	On-Screen Menu (OSM)			
	Display of items and adjustments on the menu		Volume display, input display, and screen size display	
	When screen menu is ON	When screen menu is OFF	When screen menu is ON	When screen menu is OFF
Remote control operation	Yes	Yes	Yes	No
Personal computer control operation	No	No	Yes	No

11. SHARPNESS Gain Data

Function

The external control equipment changes the SHARPNESS gain data of the plasma monitor.

Transmission Data

DFH	80H	60H	7FH	03H	DATA00	DATA01	DATA02	CKS
DATA00:	USER PICTURE	Gain Flag			01H			
DATA01:	SHARPNESS	Gain Flag			06H			
DATA02:	SHARPNESS	Gain			0FH: -16			
					FFH: -01			
					00H: 0			
					01H: +01			
					10H: +16			

ACK

7FH	60H	80H	7FH	02H	DATA00	DATA01	CKS
DATA00:	USER PICTURE	Gain Flag			01H		
DATA01:	SHARPNESS	Gain Flag			06H		

12. CONTRAST Gain Data

Function

The external control equipment changes the CONTRAST gain data of the plasma monitor.

Transmission Data

DFH	80H	60H	7FH	03H	DATA00	DATA01	DATA02	CKS
DATA00:	USER PICTURE	Gain Flag			01H			
DATA01:	CONTRAST	Gain Flag			07H			
DATA02:	CONTRAST	Gain			CCH: -52			
					FFH: -01			
					00H: 0			
					01H: +01			
					14H: +20			

ACK

7FH	60H	80H	7FH	02H	DATA00	DATA01	CKS
DATA00:	USER PICTURE	Gain Flag			01H		
DATA01:	CONTRAST	Gain Flag			07H		

13. BRIGHT Gain Data

Function

The external control equipment changes the BRIGHT gain data of the plasma monitor.

Transmission Data

DFH	80H	60H	7FH	03H	DATA00	DATA01	DATA02	CKS
DATA00:	USER PICTURE	Gain Flag			01H			
DATA01:	BRIGHT	Gain Flag			08H			
DATA02:	BRIGHT	Gain			E0H: -32			
					FFH: -01			
					00H: 0			
					01H: +01			
					20H: +32			

ACK

7FH	60H	80H	7FH	02H	DATA00	DATA01	CKS
DATA00:	USER PICTURE	Gain Flag			01H		
DATA01:	BRIGHT	Gain Flag			08H		

14. Input MODE Request

Function

The display returns the current input information by the external control equipment's request.

Transmission Data

1FH	80H	60H	41H	00H	CKS
-----	-----	-----	-----	-----	-----

ACK

7FH	60H	80H	41H	01H	DATA00	CKS
DATA00:	Input Select					
	01H: Video1				02H: Video2	
	03H: Video3				04H: HD (HD1 or DTV or DTV1)	
	05H: RGB1/PC1				06H: RGB2/PC2	
	0AH: DVD (DVD1)				0CH: HD2 (DTV2)	
	0DH: DVD2				0EH: RGB3/PC3	

15. RESET

Function

The external control equipment resets the user adjustment of the plasma monitor.

Transmission Data

1FH	80H	60H	54H	00H	CKS
-----	-----	-----	-----	-----	-----

ACK

3FH	60H	80H	54H	00H	CKS
-----	-----	-----	-----	-----	-----

16. COLOR TEMP SELECT

Function

The external control equipment changes the COLOR TEMP of the plasma monitor.

Transmission Data

DFH	80H	60H	00H	01H	DATA00	CKS
-----	-----	-----	-----	-----	--------	-----

DATA00	00H: 1
	01H: 2
	02H: 3
	03H: PRO

ACK

7FH	60H	80H	00H	01H	DATA00	CKS
-----	-----	-----	-----	-----	--------	-----

DATA00:	00H: 1
	01H: 2
	02H: 3
	03H: PRO

NOTE: Set so that at the selection of 1, 2, or 3 of COLOR TEMP change of the following R/G/B GAIN data cannot be accepted.

17. RED Gain Data

Function

The external control equipment changes the RED Gain Data of the plasma monitor.

Transmission Data

DFH	80H	60H	7FH	04H	DATA00 to DATA03	CKS
DATA00:	USER PICTURE	Gain Flag			01H	
DATA01:	RED Gain Flag				01H	
DATA02:	RED Gain 1 (Bias)				D8H: -40	
					FFH: -1	
					00H: 0	
					IEH: +30	
DATA03:	RED Gain 2 (Drive)				D8H: -40	
					FFH: -1	
					00H: 0	
					IEH: +30	

ACK

7FH	60H	80H	7FH	02H	DATA00	DATA01	CKS
DATA00:	USER PICTURE	Gain Flag			01H		
DATA01:	RED Gain Flag				01H		

18. GREEN Gain Data

Function

The external control equipment changes the GREEN Gain Data of the plasma monitor.

Transmission Data

DFH	80H	60H	7FH	04H	DATA00 to DATA03	CKS
DATA00:	USER PICTURE	Gain Flag			01H	
DATA01:	GREEN Gain Flag				02H	
DATA02:	GREEN Gain 1 (Bias)				D8H: -40	
					FFH: -1	
					00H: 0	
					IEH: +30	
DATA03:	GREEN Gain2 (Drive)				D8H: -40	
					FFH: -1	
					00H: 0	
					IEH: +30	

ACK

7FH	60H	80H	7FH	02H	DATA00	DATA01	CKS
DATA00:	USER PICTURE	Gain Flag			01H		
DATA01:	GREEN Gain Flag				02H		

19. BLUE Gain Data

Function

The external control equipment changes the BLUE Gain Data of the plasma monitor.

Transmission Data

DFH	80H	60H	7FH	04H	DATA00 to DATA03	CKS
DATA00:	USER PICTURE	Gain Flag			01H	
DATA01:	BLUE Gain Flag				03H	
DATA02:	BLUE Gain1(Bias)				D8H:-40	
					FFH:-1	
					00H: 0	
					IEH: +30	
DATA03:	BLUE Gain2(Drive)				D8H: -40	
					FFH:-1	
					00H: 0	
					IEH:+30	

ACK

7FH	60H	80H	7FH	02H	DATA00	DATA01	CKS
DATA00:	USER PICTURE	Gain Flag			01H		
DATA01:	BLUE Gain Flag				03H		

20. Multi Screen Select

Function

The external control equipment selects single screen mode or multi screen mode of the display.

Transmission Data

DFH	80H	60H	07H	01H	DATA00	CKS
DATA00:	Multi Screen					
	00: Single screen					
	01: Side by side 1 (Left screen bigger)					
	02: Side by side 2 (Left screen smaller)					
	03: Picture in Picture sub screen L					
	04: Picture in Picture sub screen R					

ACK

The display returns the following ACK.

7FH	60H	80H	07H	01H	DATA00	CKS
DATA00:	Multi Screen					
	00: Single screen					
	01: Side by side 1 (Left screen bigger)					
	02: Side by side 2 (Left screen smaller)					
	03: Picture in Picture sub screen L					
	04: Picture in Picture sub screen R					

When other commands (except POWER OFF) are sent while the screens are switching with this command, the other command will be returned as "Not Available" until screen switching is finished.

21. VIDEO ADJ Request

Function

The display returns the video adjustments information by the external control equipment's request.

Transmission Data

1FH 80H 60H 45H 00H CKS

ACK

7FH 60H 80H 45H 0CH DATA00 to DATA0B CKS

DATA00: RED Gain(Bias)

D8H: -40

FFH: -1
00H: 0
IEH: +30

DATA01: GREEN Gain(Bias)

D8H: -40

FFH: -1
00H: 0
IEH: +30

DATA02: BLUE Gain(Bias)

D8H: -40

FFH: -1
00H: 0
IEH: +30

DATA03: COLOR Gain

E0H: -32

FFH: -01
00H: 0
01H: +01
20H: +32

* COLOR Gain is from -22 (EAH) to +22 (16H) only during video.

DATA04: TINT Gain

E0H: -32

FFH: -01
00H: 0
01H: +01
20H: +32

* TINT Gain is from -22 (EAH) to +22 (16H) only during video.

DATA05: SHARPNES Gain

F0H: -16

FFH: -01
00H: 0
01H: +01
10H: +16

DATA06: CONTRAST Gain

CCH: -52

FFH: -01
00H: 0
01H: +01
14H: +20

DATA07: BRIGHT Gain

E0H: -32

FFH: -01
00H: 0
01H: +01
20H: +32

DATA08: RED Gain(Drive)

D8H: -40

FFH: -1
00H: 0
IEH: +30

DATA09: GREEN Gain(Drive)

D8H: -40

FFH: -1
00H: 0
IEH: +30

DATA0A: BLUE Gain(Drive)

D8H: -40

FFH: -1
00H: 0
IEH: +30

DATA0B: COLOR TEMP

00H: 1
01H: 2
02H: 3
03H: PRO

22. Audio Select Set

Function

The external control equipment sets combinations of audio and video inputs for the plasma monitor.

Transmission Data

DFH	80H	60H	70H	02H	DATA00	DATA01	CKS
DATA00:	AUDIO INPUT						
	01H:	AUDIO 1					
	02H:	AUDIO 2					
	03H:	AUDIO 3					
DATA01:	VISUAL INPUT						
	01H:	Video 1					
	02H:	Video 2					
	03H:	Video 3					
	05H:	HD (HD1 or DTV or DTV1)					
	06H:	HD2 (DTV2)					
	07H:	RGB 1/ PC 1					
	08H:	RGB 2/ PC 2					
	0CH:	RGB 3/ PC 3					

ACK

The plasma monitor returns the following ACK when the input is switched.

3FH	60H	80H	70H	00H	CKS
-----	-----	-----	-----	-----	-----

* The plasma monitor returns “Not Available” when selecting the video input same as the one set at one of the AUDIO 01 to 3.

Example:

The plasma monitor returns “Not Available” when selecting the VIDEO1 for AUDIO2 or VIDEO3 after VIDEO1 has been set to AUDIO1.

23. Audio Select Request

Function

The external control equipment inquires the current combinations of audio and video inputs for the plasma monitor.

Transmission Data

1FH	80H	60H	6FH	00H	CKS
-----	-----	-----	-----	-----	-----

ACK

The plasma monitor returns the following ACK:

7FH	60H	80H	6FH	03H	DATA00	DATA01	DATA02	CKS
-----	-----	-----	-----	-----	--------	--------	--------	-----

DATA00:	AUDIO 1							
	01H – 0CH:	VISUAL INPUT DATA						
DATA01:	AUDIO 2							
	01H – 0CH:	VISUAL INPUT DATA						
DATA02:	AUDIO 3							
	01H – 0CH:	VISUAL INPUT DATA						
	VISUAL INPUT DATA							
	01H:	Video 1						
	02H:	Video 2						
	03H:	Video 3						
	05H:	HD (HD1 or DTV or DTV 1)						
	06H:	HD2 (DTV2)						
	07H:	RGB 1/PC 1						
	08H:	RGB 2/PC 2						
	0CH:	RGB 3/PC 3						

24. LONG LIFE Set

Function

The external control equipment sets the PLE, ORBITER, and INVERSE (inverse of image brightness) of the plasma monitor.

Transmission Data

DFH	80H	60H	6BH	03H	DATA00	DATA01	DATA02	CKS
DATA00 :	PLE							
	01H:	AUTO						
	02H:	LOCK						
DATA01 :	INVERSE							
	01H:	ON						
	02H:	OFF						
	03H:	WHITE						
DATA02 :	ORBITER (PICTURE SHIFT)							
	01H:	ON						
	02H:	OFF						

ACK

The plasma monitor returns the following ACK when setting the PLE, ORBITER, and INVERSE (inverse of image brightness):

3FH	60H	80H	6BH	00H	CKS
-----	-----	-----	-----	-----	-----

25. Failure Mode Request

Function

The external control equipment inquires the detection of failures of the plasma monitor.

Transmission Data

1FH	80H	60H	3FH	00H	CKS
-----	-----	-----	-----	-----	-----

ACK

The plasma monitor returns the following ACK:

7FH	60H	80H	3FH	02H	DATA00	DATA01	CKS
-----	-----	-----	-----	-----	--------	--------	-----

DATA00:	FAILURE MODE 1							
	Bit 0 :	PDP MODULE						
		0: Abnormal						
		1: Normal						
	Bit 1 :	1: fixed (backup)						
	Bit 2 :	TEMPERATURE						
		0: Abnormal						
		1: Normal						
	Bit 3 :	FAN						
		0: Abnormal						
		1: Normal						
	Bit 4 :	1: fixed (backup)						
	Bit 5 :	1: fixed (backup)						
	Bit 6 :	1: fixed (backup)						
	Bit 7 :	1: fixed (backup)						
DATA01:	FAILURE MODE 2							
	Bit 0–7 :	1: fixed (backup)						

Table of Signals Supported

Supported resolution

- When the screen mode is NORMAL, each signal is converted to a 1024 dots × 768 lines signal. (Except for *2,3,4)
- When the screen mode is TRUE, the picture is displayed in the original resolution.
- When the screen mode is FULL, each signal is converted to a 1364 dots × 768 lines signal. (Except for *3)

Computer input signals supported by this system

Model Signal Type	Dots × lines	Vertical frequency (Hz)	Horizontal frequency (kHz)	Sync Polarity		Presence		Screen mode			RGB select*5	DVI
				Horizontal	Vertical	Horizontal	Vertical	NORMAL (4:3)	TRUE	FULL (16:9)		
	640 × 400	70.1	31.5	NEG	NEG	YES	YES	YES*2	YES	YES	--	NO
*IBM PC/AT compatible computers	640 × 480	59.9	31.5	NEG	NEG	YES	YES	YES	YES	YES	STILL	YES
		72.8	37.9	NEG	NEG	YES	YES	YES	YES	YES	--	YES
		75.0	37.5	NEG	NEG	YES	YES	YES	YES	YES	STILL	YES
		85.0	43.3	NEG	NEG	YES	YES	YES	YES	YES	--	YES
		100.4	51.1	NEG	NEG	YES	YES	YES	YES	YES	--	YES
		120.4	61.3	NEG	NEG	YES	YES	YES	YES	YES	--	YES
	848 × 480	60.0	31.0	POS	POS	YES	YES	--	YES	YES	WIDE2	YES
	852 × 480*1	60.0	31.7	NEG	NEG	YES	YES	--	YES	YES	WIDE1	YES
	800 × 600	56.3	35.2	POS	POS	YES	YES	YES	YES	YES	STILL	YES
		60.3	37.9	POS	POS	YES	YES	YES	YES	YES	STILL	YES
		72.2	48.1	POS	POS	YES	YES	YES	YES	YES	--	YES
		75.0	46.9	POS	POS	YES	YES	YES	YES	YES	--	YES
		85.1	53.7	POS	POS	YES	YES	YES	YES	YES	--	YES
		99.8	63.0	POS	POS	YES	YES	YES	YES	YES	--	YES
	1024 × 768	120.0	75.7	POS	POS	YES	YES	YES	YES	YES	--	YES
		60.0	48.4	NEG	NEG	YES	YES	YES*3	--	YES	STILL	YES
		70.1	56.5	NEG	NEG	YES	YES	YES*3	--	YES	--	YES
		75.0	60.0	POS	POS	YES	YES	YES*3	--	YES	STILL	YES
		85.0	68.7	POS	POS	YES	YES	YES*3	--	YES	--	YES
	1152 × 864	100.6	80.5	NEG	NEG	YES	YES	YES*3	--	YES	--	NO
		75.0	67.5	POS	POS	YES	YES	YES	--	YES	STILL	YES
	1280 × 768	56.2	45.1	POS	POS	YES	YES	--	--	YES	WIDE1	NO
	1360 × 765	60.0	47.7	POS	POS	YES	YES	--	--	YES*3	WIDE1	NO
1360 × 768	60.0	47.7	POS	POS	YES	YES	--	--	YES*3	WIDE1	NO	
1376 × 768	59.9	48.3	NEG	POS	YES	YES	--	--	YES	WIDE2	YES	
1280 × 1024	60.0	64.0	POS	POS	YES	YES	YES*4	--	YES	STILL	YES	
	75.0	80.0	POS	POS	YES	YES	YES*4	--	YES	--	NO	
	85.0	91.1	POS	POS	YES	YES	YES*4	--	YES	--	NO	
1600 × 1200	60.0	75.0	POS	POS	YES	YES	YES	--	YES	--	NO	
	65.0	81.3	POS	POS	YES	YES	YES	--	YES	--	NO	
	70.0	87.5	POS	POS	YES	YES	YES	--	YES	--	NO	
	75.0	93.8	POS	POS	YES	YES	YES	--	YES	--	NO	
*Apple Macintosh*6	640 × 480	66.7	35.0	Sync on G	Sync on G	--	--	YES	YES	YES	--	NO
	832 × 624	74.6	49.7	Sync on G	Sync on G	--	--	YES	YES	YES	--	NO
	1024 × 768	74.9	60.2	Sync on G	Sync on G	--	--	YES*3	--	YES	--	NO
	1152 × 870	75.1	68.7	Sync on G	Sync on G	--	--	YES	--	YES	--	NO
Work Station (EWS4800)	1280 × 1024	60.0	64.6	NEG	NEG	YES	YES	YES*4	--	YES	--	NO
		71.2	75.1	NEG	NEG	YES	YES	YES*4	--	YES	--	NO
Work Station (HP)	1280 × 1024	72.0	78.1	--	--	--	--	YES*4	--	YES	--	YES
Work Station (SUN)	1152 × 900	76.0	71.7	C Sync	C Sync	--	--	YES	--	YES	--	NO
		76.0	71.7	C Sync	C Sync	--	--	YES	--	YES	--	NO
	1280 × 1024	76.1	81.1	C Sync	C Sync	--	--	YES*4	--	YES	--	NO
Work Station (SGI)	1024 × 768	60.0	49.7	--	--	--	--	YES*3	--	YES	--	NO
	1280 × 1024	60.0	63.9	--	--	--	--	YES*4	--	YES	--	YES
IDC-3000G												YES
PAL625P	768 × 576	50.0	31.4	NEG	NEG	YES	YES	YES*7	--	YES*7	--	NO
	NTSC525P	640 × 480	59.9	31.5	NEG	NEG	YES	YES	YES*7	--	YES*7	MOTION

-
- *1 Only when using a graphic accelerator board that is capable of displaying 852×480 .
 - *2 This signal is converted to a $1228 \text{ dots} \times 768 \text{ lines}$ signal.
 - *3 The picture is displayed in the original resolution.
 - *4 The aspect ratio is 5:4. This signal is converted to a $960 \text{ dot} \times 768 \text{ line}$ signal.
 - *5 Normally the RGB select mode suite for the input signals is set automatically. If the picture is not displayed properly, set the RGB mode prepared for the input signals listed in the table above.
 - *6 To connect the monitor to Macintosh computer, use the supplied monitor adapter (D-Sub 15-pin) to your computer's video port. If your computer has a mini D-Sub 15-pin connector, you may have to use the supplied RGB cable.
 - *7 Other screen modes (ZOOM and STADIUM) are available as well.

NOTE:

- *While the input signals comply with the resolution listed in the table above, you may have to adjust the position and size of the picture or the fine picture because of errors in synchronization of your computer.*
 - *When a $1280 \text{ dot} \times 1024 \text{ line}$ signal or $1600 \text{ dot} \times 1200 \text{ line}$ signal is input to the monitor, the picture will be compressed.*
 - *This monitor has a resolution of $1365 \text{ dot} \times 768 \text{ line}$. It is recommended that the input signal should be XGA, wide XGA, or equivalent.*
 - *With digital input some signals are not accepted.*
 - *The sync may be disturbed when a nonstandard signal other than the aforementioned is input.*
 - *If you are connecting a composite sync signal, use the HD terminal.*
-

- * "IBM PC/AT" and "VGA" are registered trademarks of IBM, Inc. of the United States.
- * "Apple Macintosh" is a registered trademark of Apple Computer, Inc. of the United States.

Troubleshooting

If the picture quality is poor or there is some other problem, check the adjustments, operations, etc., before requesting service.

Symptom	Checks	Remedy
Picture is disturbed. Sound is noisy. Remote control operates erroneously.	<ul style="list-style-type: none"> Is a connected component set directly in front or at the side of the display? 	<ul style="list-style-type: none"> Leave some space between the display and the connected components.
The remote control does not work.	<ul style="list-style-type: none"> Are the remote control's batteries worn out? 	<ul style="list-style-type: none"> Replace both batteries with new ones.
Monitor's power does not turn on when the remote control's power button is pressed.	<ul style="list-style-type: none"> Is the monitor's power cord plugged into a power outlet? 	<ul style="list-style-type: none"> Plug the monitor's power cord into a power outlet.
	<ul style="list-style-type: none"> Are all the monitor's indicators off? 	<ul style="list-style-type: none"> Press the power button on the monitor to turn on the power.
	<ul style="list-style-type: none"> Are the remote control's batteries worn out? 	<ul style="list-style-type: none"> Replace both batteries with new ones.
Monitor does not operate when the remote control's buttons are pressed.	<ul style="list-style-type: none"> Is the remote control pointed at the monitor, or is there an obstacle between the remote control and the monitor? 	<ul style="list-style-type: none"> Point the remote control at the monitor's remote control sensor when pressing buttons, or remove the obstacle.
	<ul style="list-style-type: none"> Is direct sunlight or strong artificial light shining on the monitor's remote control sensor? 	<ul style="list-style-type: none"> Eliminate the light by closing curtains, pointing the light in a different direction, etc.
	<ul style="list-style-type: none"> Are the remote control's batteries worn out? 	<ul style="list-style-type: none"> Replace both batteries with new ones.
	<ul style="list-style-type: none"> The remote cable is plugged into the REMOTE IN terminal (Wired). 	<ul style="list-style-type: none"> Unplug the remote cable from the monitor.
	<ul style="list-style-type: none"> The front panel buttons of the main unit do not function. 	<ul style="list-style-type: none"> The front panel buttons do not function during Control Lock.
No sound or picture is produced.	<ul style="list-style-type: none"> Is the monitor's power cord plugged into a power outlet? 	<ul style="list-style-type: none"> Plug the monitor's power cord into a power outlet.
Picture appears but no sound is produced.	<ul style="list-style-type: none"> Is the volume set at the minimum? 	<ul style="list-style-type: none"> Increase the volume.
	<ul style="list-style-type: none"> Is the mute mode set? 	<ul style="list-style-type: none"> Press the remote control's MUTE button.
	<ul style="list-style-type: none"> Are the speakers properly connected? 	<ul style="list-style-type: none"> Connect the speakers properly.
	<ul style="list-style-type: none"> Is AUDIO INPUT set correctly? 	<ul style="list-style-type: none"> Set AUDIO INPUT on the OPTION menu correctly.
Poor picture with VIDEO signal input.	<ul style="list-style-type: none"> Improper control setting. Local interference. Cable interconnections. Input impedance is not correct level. 	<ul style="list-style-type: none"> Adjust picture control as needed. Try another location for the monitor. Be sure all connections are secure.
Poor picture with RGB signal input.	<ul style="list-style-type: none"> Improper control setting. Incorrect 15 PIN connector pin connections. 	<ul style="list-style-type: none"> Adjust picture controls as needed. Check pin assignments and connections.
Tint is poor or colors are weak.	<ul style="list-style-type: none"> Are the tint and colors properly adjusted? 	<ul style="list-style-type: none"> Adjust the tint and color (under "PICTURE").
Nothing appears on screen.	<ul style="list-style-type: none"> Is the computer's power turned on? 	<ul style="list-style-type: none"> Turn on the computer's power.
	<ul style="list-style-type: none"> Is a source connected? 	<ul style="list-style-type: none"> Connect source to the monitor.
	<ul style="list-style-type: none"> Is the power management function in the standby or off mode? 	<ul style="list-style-type: none"> Operate the computer (move the mouse, etc.).
Part of picture is cut off or picture is not centered.	<ul style="list-style-type: none"> Is the position adjustment appropriate? 	<ul style="list-style-type: none"> Adjust the "SCREEN" properly.
Image is too large or too small.	<ul style="list-style-type: none"> Is the screen size adjustment appropriate? 	<ul style="list-style-type: none"> Press the "WIDE" button on the remote control and adjust properly.
Picture is unstable.	<ul style="list-style-type: none"> Is the computer's resolution setting appropriate? 	<ul style="list-style-type: none"> Set to the proper resolution.
POWER/STANDBY indicator is lighted in orange or red.	<ul style="list-style-type: none"> Horizontal and / or vertical sync signal is not present when the Intelligent Power Manager control is on. 	<ul style="list-style-type: none"> Check the input signal.
POWER/STANDBY indicator is blinking in red.	<ul style="list-style-type: none"> The temperature inside the main unit has become too high and has activated the protector. 	<ul style="list-style-type: none"> Promptly switch off the power of the main unit and wait until the internal temperature drops. See*1.
POWER/STANDBY indicator is blinking in green.	<p style="text-align: center;">_____</p>	<ul style="list-style-type: none"> Promptly switch off the power of the main unit. See *2.

*1 Overheat protector

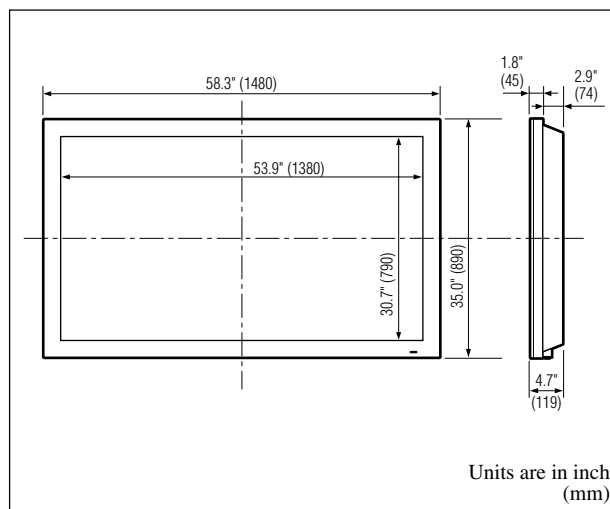
If the monitor becomes too hot, the overheat protector will be activated and the monitor will be turned off. If this happens., turn off the power to the monitor and unplug the power cord. If the room where the monitor is installed is particularly hot, move the monitor to a cooler location and wait for the monitor to cool for 60 minutes. If the problem persists, contact your NEC dealer for service.

*2 In the following case, power off the monitor immediately and contact your dealer or authorized NEC Service Center.

The monitor turns off 5 seconds after powering on and then the POWER/STANDBY indicator blinks. It indicates that the power supply circuit or, one or more fans have been damaged.

Specifications

Product Name	PlasmaSync 61MP1 Plasma Monitor
Product Code	PX- 61XM1G
Screen Size	53.2"(H) × 29.9"(V) inches 1351(H) × 760(V) mm diagonal 61"
Aspect Ratio	16 : 9
Resolution	1365(H) × 768(V) pixels
Pixel Pitch	0.039"(H) × 0.039"(V) inches 0.987(H) × 0.987(V) mm
Color Reproduction	256 levels, 16,770,000 colors
Signals	
Synchronization Range	Horizontal : 15.5 to 93.8 kHz (automatic : step scan) Vertical : 50.0 to 120 Hz (automatic : step scan)
Input Signals	RGB, NTSC (3.58/4.43), PAL (B,G,M,N), PAL60, SECAM, HD* ¹ , DVD* ¹ , DTV* ¹
Input Terminals	
RGB	
Visual 1 (Analog)	mini D-sub 15-pin × 1
Visual 2 (Analog)	BNC (R, G, B, H/CS, V) × 1* ³
Visual 3 (Digital)	DVI-I 29-pin × 1* ² (Not compatible with analog input)
Video	
Visual 1	RCA-pin × 1
Visual 2	BNC × 1
Visual 3	S ₂ -Video: DIN 4-pin × 1
DVD/HD/DTV	
Visual	RCA-pin (Y, PB[CB], PR[CR])* ¹
Audio	Stereo RCA × 3 (selectable)
External Control	D-sub 9-pin × 1(RS-232C)
Sound output	7W+7W at 6 ohm
Power Supply	AC100-240V 50/60Hz
Current Rating	8.3A (maximum)
Power Consumption	660W (typical)
Dimensions	58.3 (W) × 35.0 (H) × 4.7 (D) inches 1480 (W) × 890 (H) × 119(D) mm
Weight	134.5 lbs / 61.0 kg
Environmental Considerations	
Operating Temperature	0°C to 35°C / 32°F to 95°F
Humidity	20 to 80%
Storage Temperature	-10°C to 50°C / 14°F to 122°F
Humidity	10 to 90%
Front Panel User Controls	Power on/off, Input source select, Volume up/down, OSM control
Remote Control Functions	Power on/off, Input source select, OSM control, Volume up/down, Cursor (UP, DOWN, LEFT, RIGHT), Pointer, Zoom up/ down, Off timer, Wireless / Wired remote control
OSM Functions	Picture (Contrast / Brightness / Sharpness / Color / Tint / Picture mode / Color temperature / Noise reductions), Sound (Bass / Treble / Balance), Screen (V- Position / H-Position / V-Height / H- Width / Auto Picture / Fine picture / Picture adjustment), Function (OSM / OSM adjustment / Power management / Gray level / Cinema mode / RGB3 Adjustment, Long Life (PLE, Orbiter, Inverse, White) / Reset) / Option (Audio input / BNC select / RGBselect / HD select / Picture Size), Information (Frequency / Language / Color system)



The features and specifications may be subject to change without notice.

*¹ HD/DVD/DTV input signals supported on this system

480P (60 Hz)	480I (60 Hz)
525P (60 Hz)	525I (60 Hz)
625P (50 Hz)	625I (50 Hz)
720P (60 Hz)	1035I (60 Hz)
	1080I (60 Hz)

*² It doesn't cope with copy protection.

*³ A change of DVD2/HD2 can be performed with RGB2.

Other Features	3D motion adaptive Scan Converter (with 2-3 pull down Converter), Digital Zoom function (100-300% Selectable) (Tentative), Self Diagnosis, Anti Image Burn, Color Temperature Select, Control Lock, Power management, Plug and play (DDC1, DDC2b, RGB3: DDC2b only), Multi screen operation
Accessories	Remote control with two AAA batteries, Remote cable, RGB cable (Mini D-Sub 15-pin to Mini D-Sub 15-pin connector), Power cord, User's Manual, Safety metal fittings, Ferrite cores, Bands
Regulations	Meets class A requirements (EN55022, EN61000-3-2, EN61000-3-3, EN55024) Meets Low Voltage Directive (EN60950, SEMKO Approved) Meets AS/NZS 3548 Class A

TROUBLESHOOTING

TROUBLESHOOTING

1. Failure in the power supply

In the case of any abnormality in the power supply like no power available, go to “1. No power available” (P. 2).

2. Video error

(1) In the case of a video input error in VIDEO 1, 2, 3 (S-VIDEO), go to 2-1. “No video input signals available at VIDEO 1, 2, 3 (S-VIDEO)” (P. 6).

(2) In the case of a video error in the RGB 1 and 2 input circuits, go to 2-2. “No video input signals available at the RGB 1 and 2 input circuits (P. 9).

In this case, however, note the following:

① If the error remains only in the interlace motion pictures, go to 2-5. “No interlace motion pictures generated for VIDEO, DVD, HDTV, etc.” (P. 13).

② If the error remains only in the progressive motion pictures, go to 2-6. “No progressive motion pictures generated” (P. 14).

③ If the error remains only in the still pictures of PC, etc., go to 2-7. “No still pictures of PC, etc. generated” (P. 15).

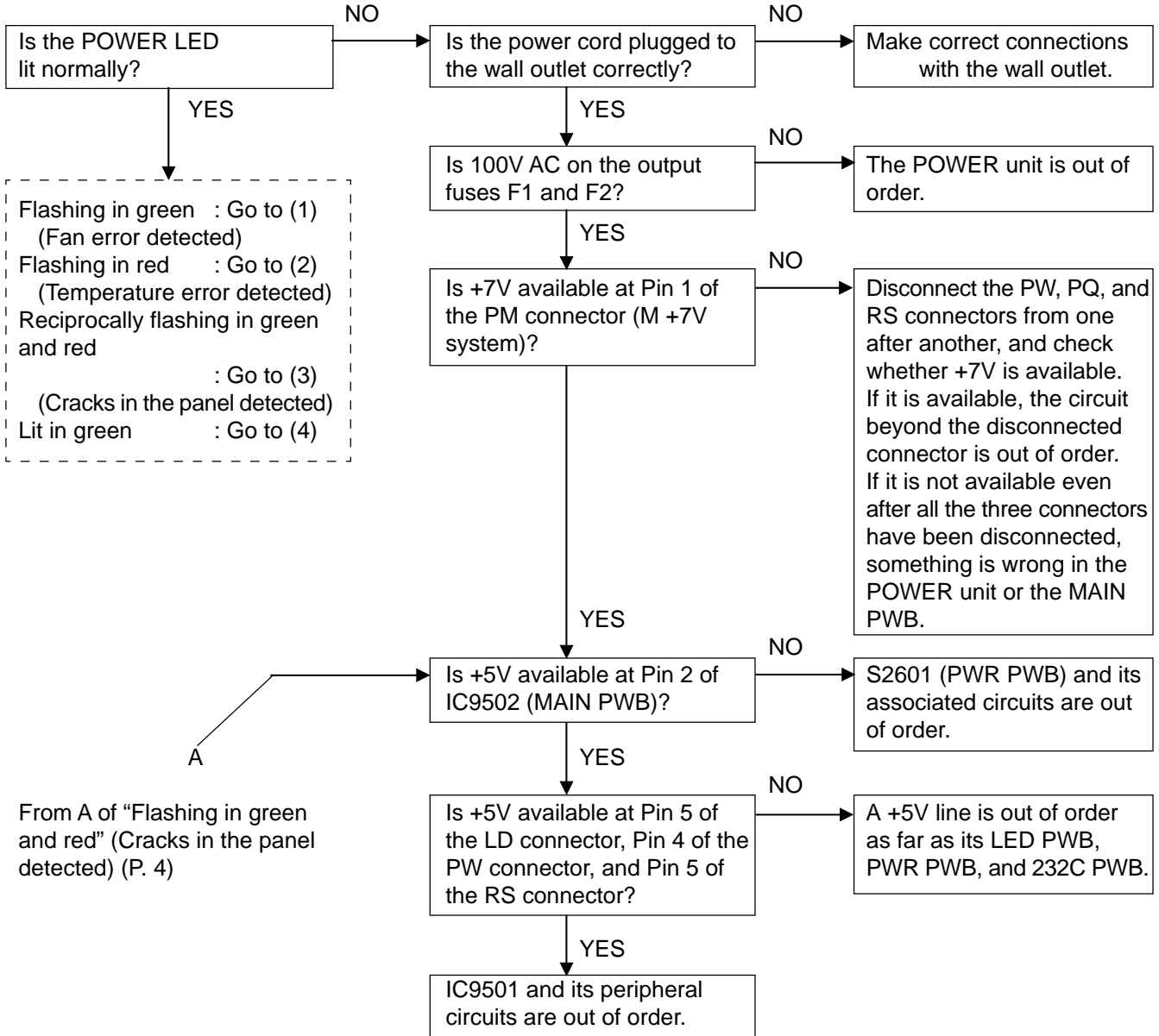
(3) In the case of a video error in the DVD/HD input circuit, go to 2-3. “No video signals available at the DVD/HD input circuit (P. 10).

If this error remains only in the progressive motion pictures, go to 2-6. “No progressive motion pictures generated” (P. 14).

(4) If a video error occurs irrespective of any input selection, go to 2-4. “No video pictures available even with any input selection (P. 11).

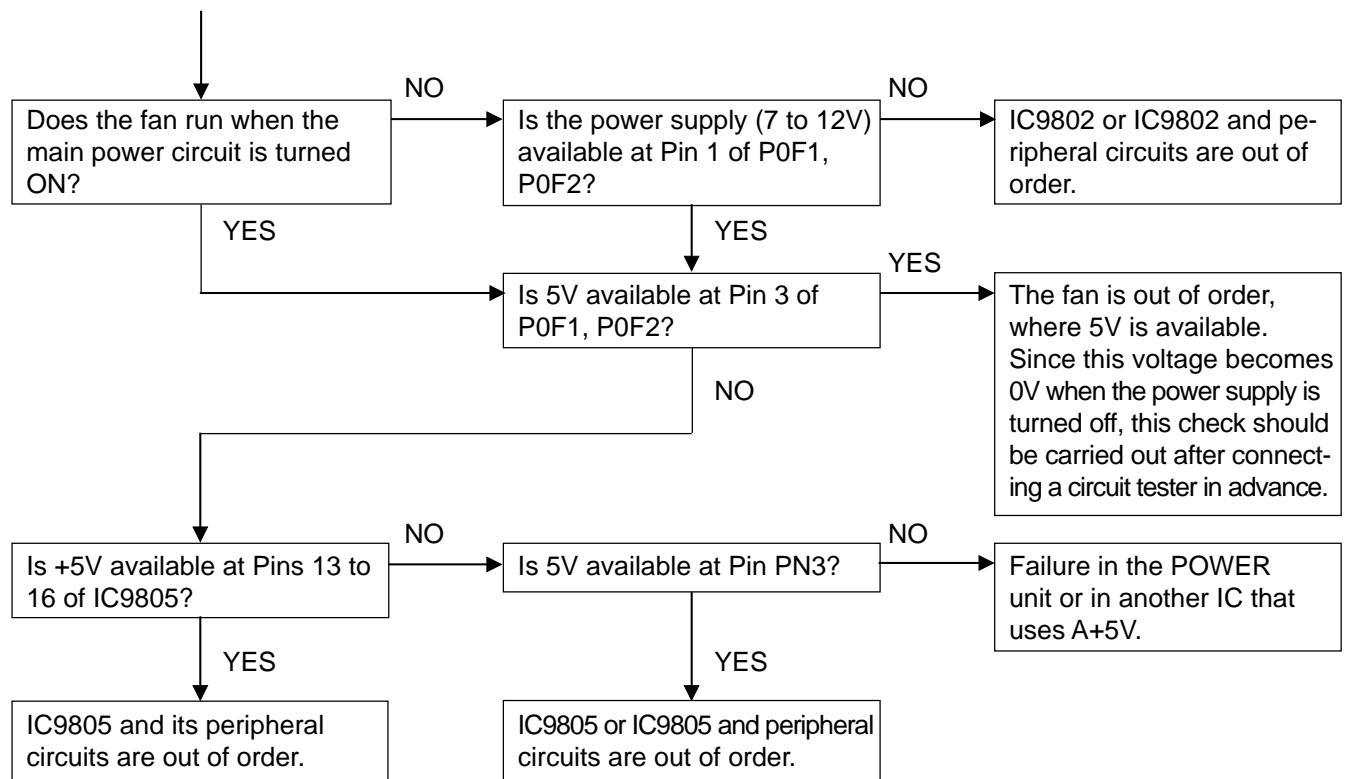
(Caution) If there is a description of □□□□ and peripheral circuit in the flow chart, the circuits used to control the □□□□ and the peripheral circuit (example: a bus from a microcomputer) are included.

1. No power available



(Caution) When an LED is flashing (in the case of protector in operation), all power lines other than the M+7 system are automatically turned off. When checking these power lines other than the M+7 system, do it after connecting a circuit tester or the like to the measuring point, without fail.

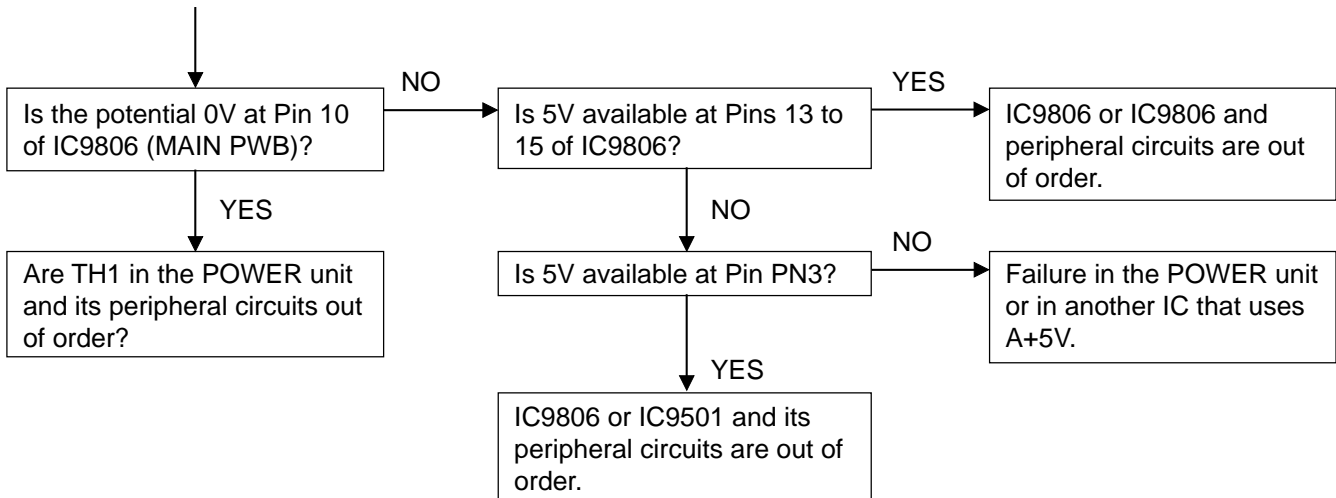
(1) Flashing in green (Fan error detected)



(Caution) How to reset the alarm:

- Turn the power circuit off and on at the main power supply.

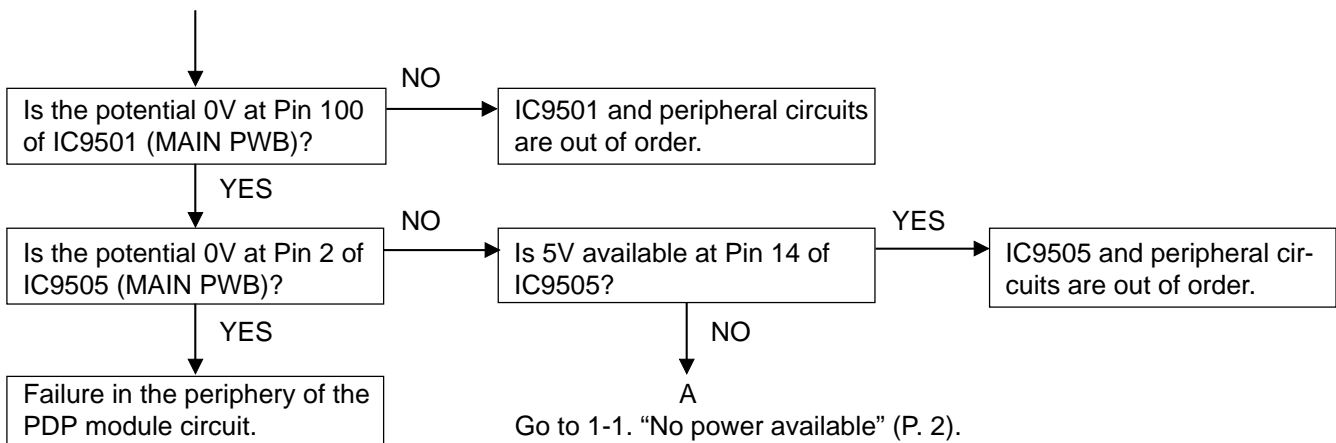
(2) Flashing in red (Temperature error detected)



(Caution) How to reset the alarm:

- Turn the power circuit off and on at the main power supply.

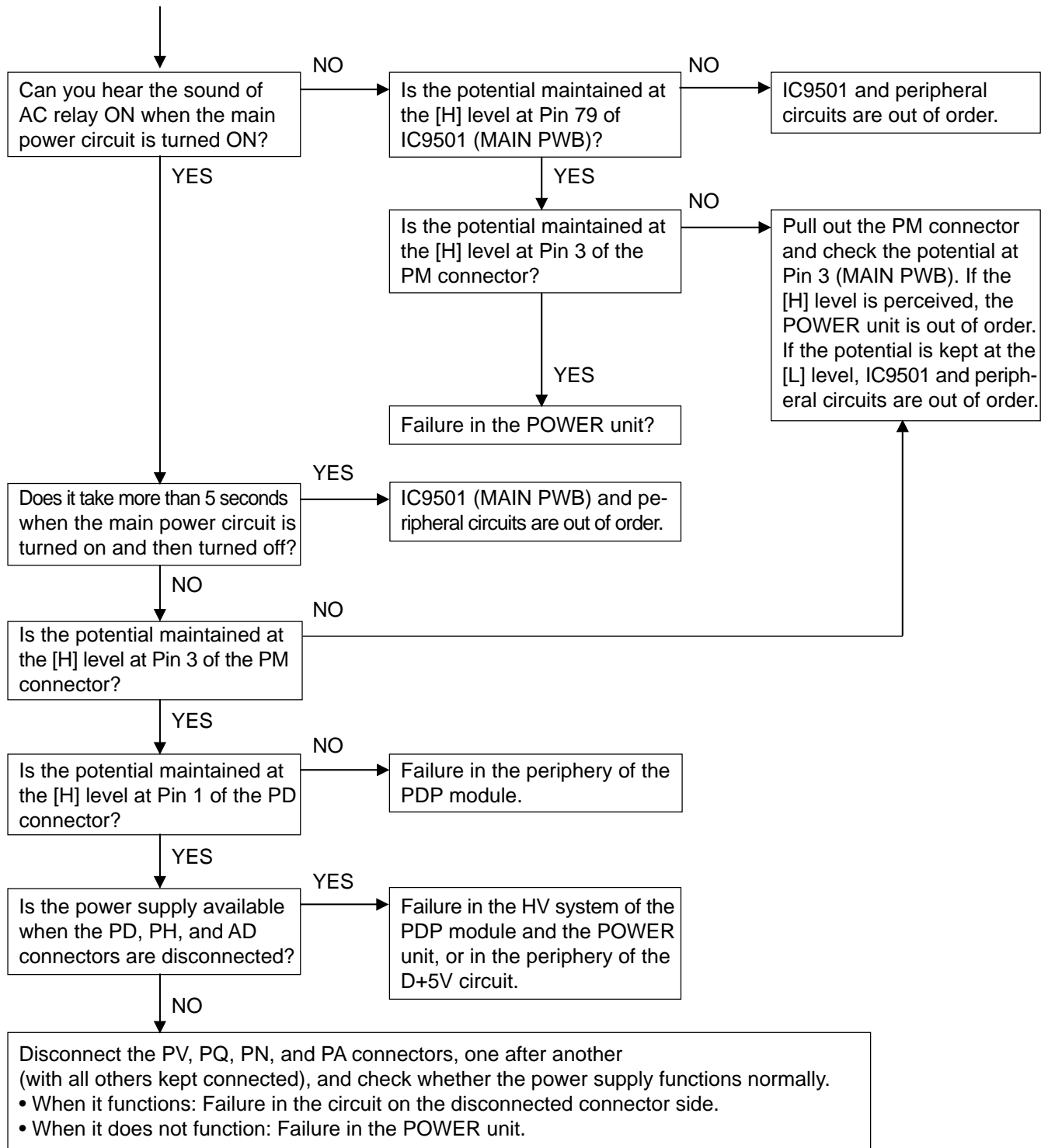
(3) Reciprocally flashing in green and red (Cracks in the panel detected)



(Caution) How to reset the alarm:

- Turn the power circuit [ON], with the input changeover key of the product kept pressed. In this state, keep on pressing the input changeover key for more than 2 seconds.

(4) Lit in green



2. Video error

2-1. No video input signals available at VIDEO 1, 2, 3 (S-VIDEO)

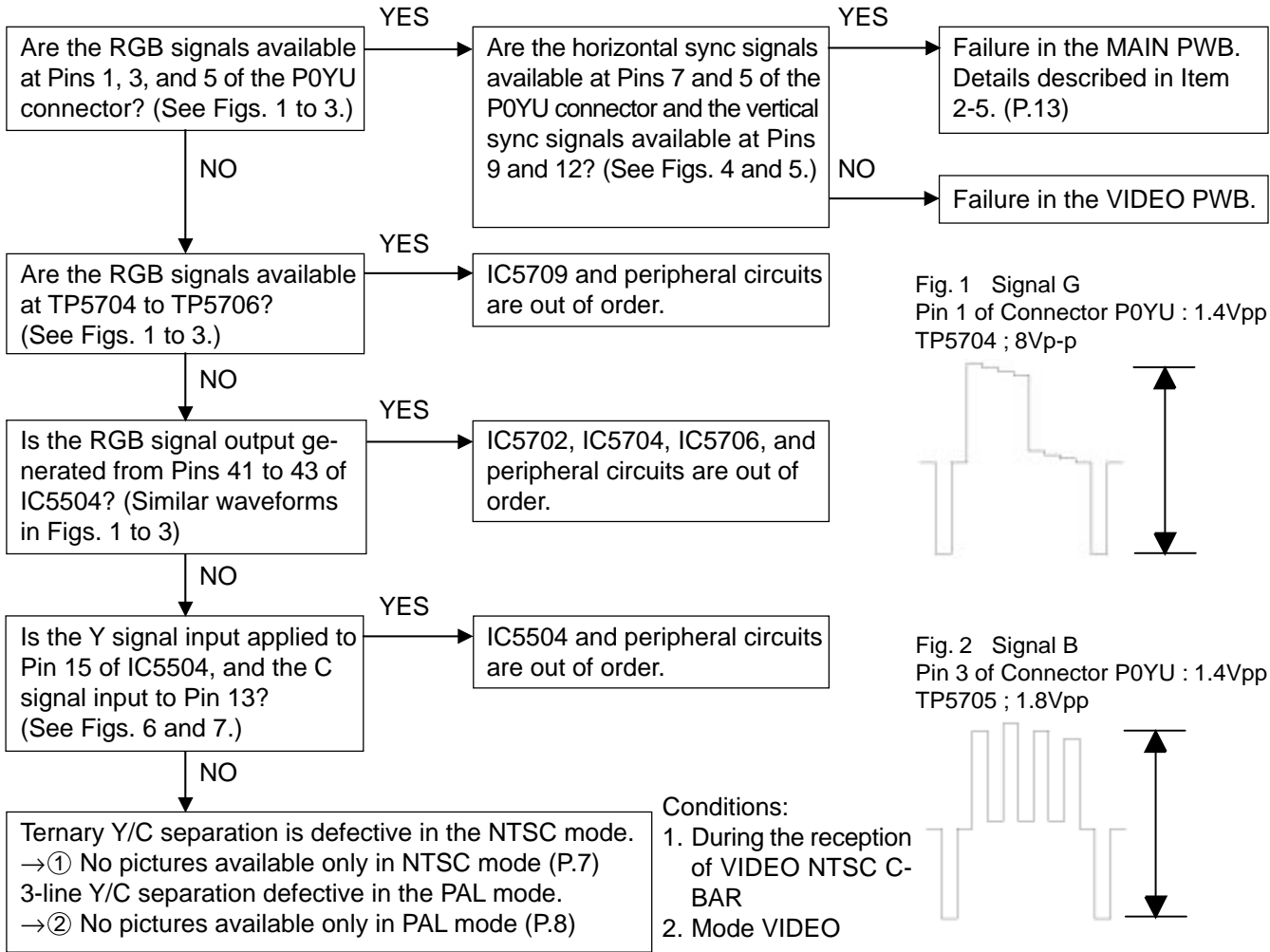


Fig. 1 Signal G
Pin 1 of Connector P0YU : 1.4Vpp
TP5704 ; 8Vp-p

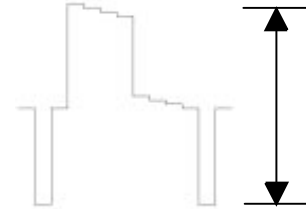


Fig. 2 Signal B
Pin 3 of Connector P0YU : 1.4Vpp
TP5705 ; 1.8Vpp

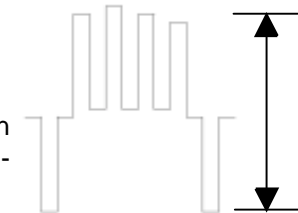


Fig. 3 Signal R
Pin 5 of Connector P0YU : 1.4Vpp
TP5706 ; 1.8Vpp

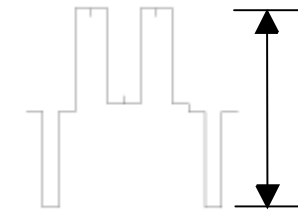


Fig. 4
Pins 7 and 10 of Connector P0YU
(horizontal sync signals)

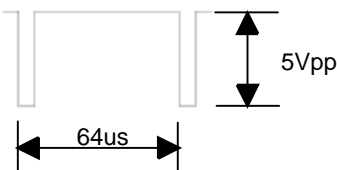


Fig. 5
Pins 9 and 12 of Connector P0YU
(vertical sync signals)

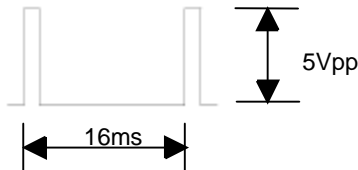


Fig. 6
Signal Y at Pin 15 of IC5504

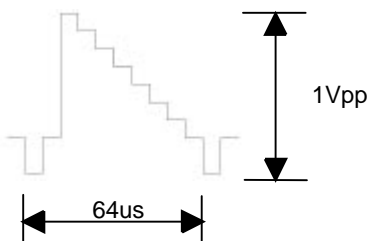
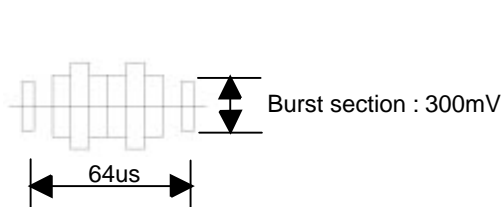


Fig. 7
Signal C at Pin 13 of IC5504



① No pictures available only in the NTSC mode (ternary Y/C separation defective)

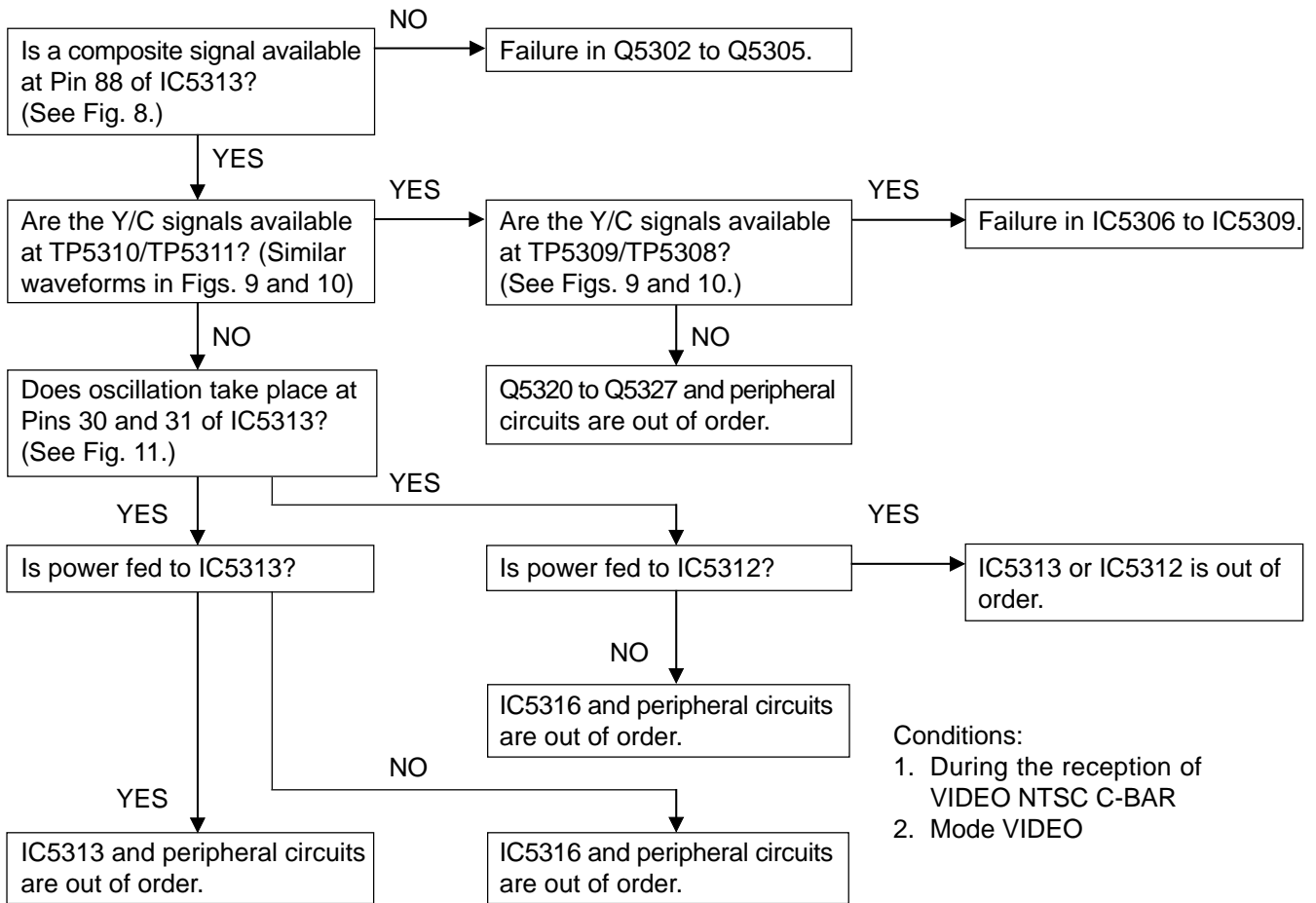


Fig. 8
Signal VIDEO at Pin 8 of IC5313

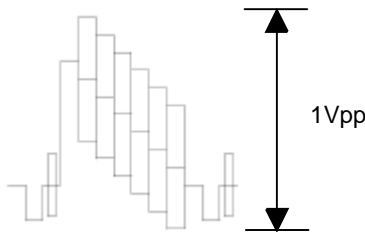


Fig. 9
Signal Y at TP5308

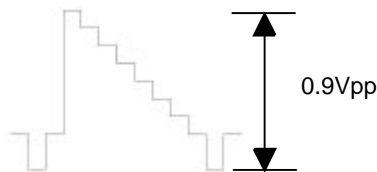


Fig. 10
Signal C at TP5309

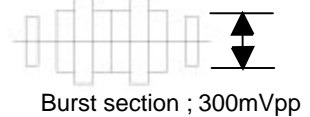
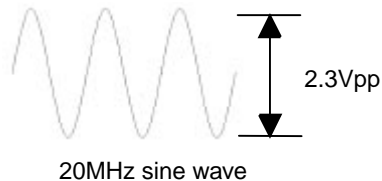


Fig. 11
Oscillation waveform at Pin 30 of IC5313



② No pictures available only in PAL mode (3-line Y/C separation defective)

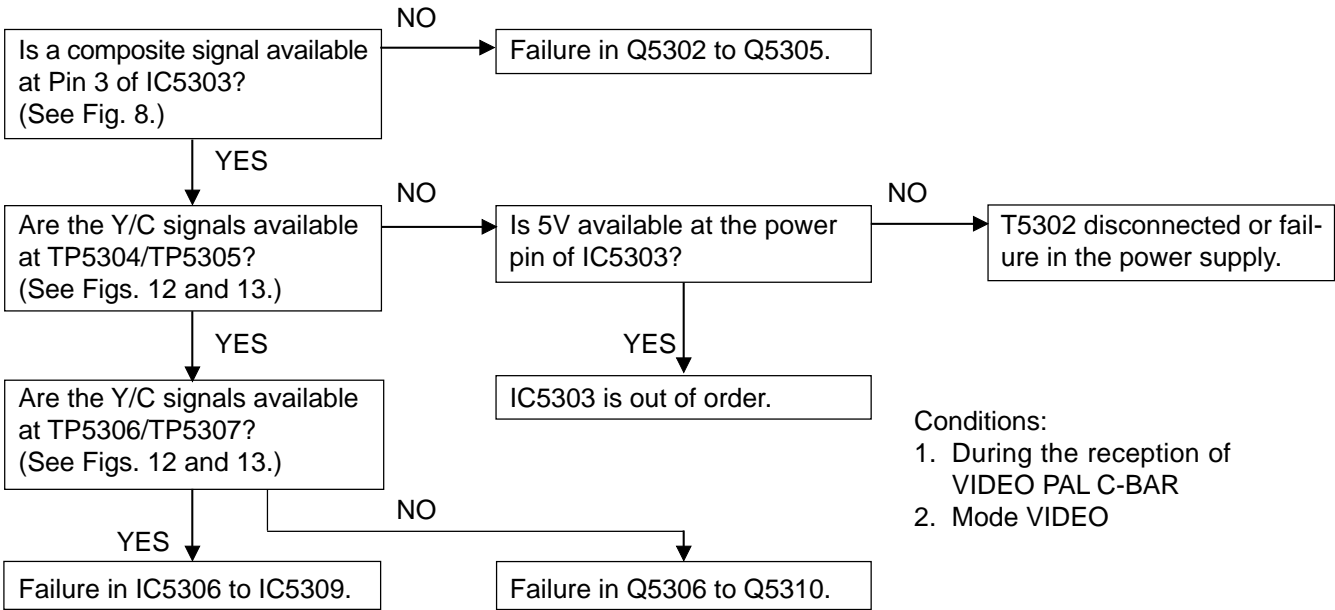


Fig. 12 Signal Y
 TP5304 1.2Vpp
 TP5306 1Vpp

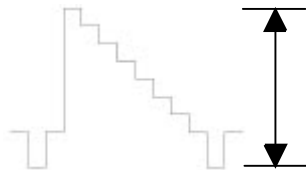
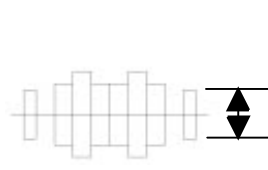


Fig. 13 Signal C
 TP5305 Burst section : 300mVpp
 TP5307 Burst section : 300mVpp



2-2. No video input signals available at the RGB 1 and 2 input circuits

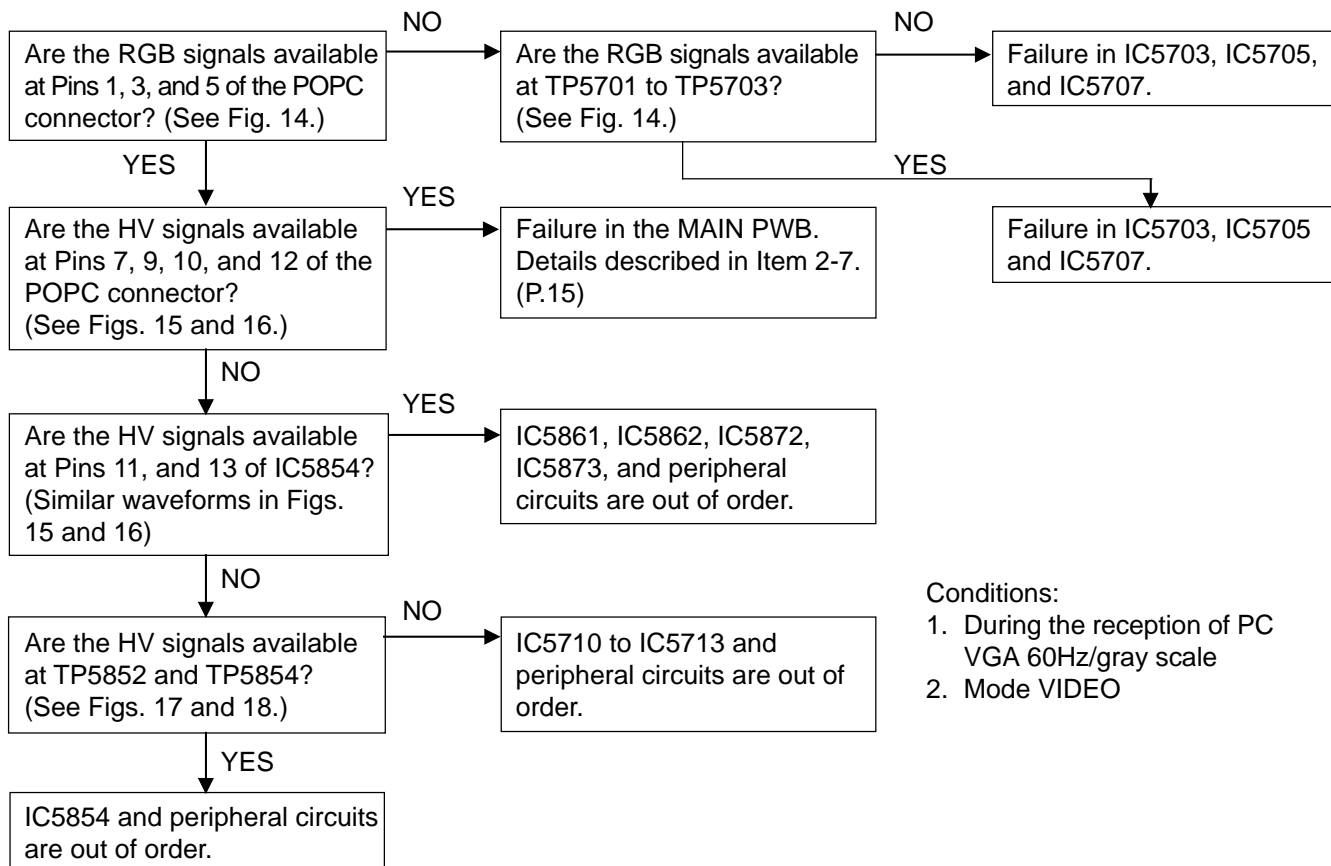


Fig. 14 Signal RGB Pins 1, 3, and 5 of connector P0PC



Fig. 15 Horizontal Sync Signals Pins 13 of IC5864

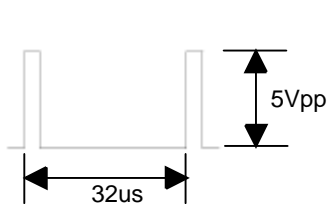


Fig. 16 Vertical Sync Signals Pins 11 of IC5864

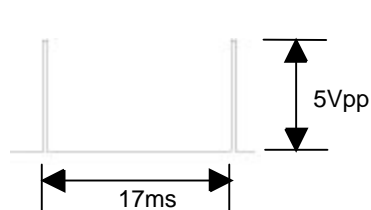


Fig. 17 Horizontal Sync Signals TP5852

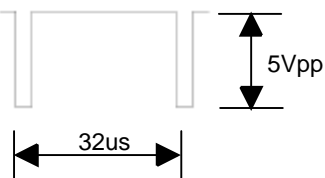


Fig. 18 Vertical Sync Signals TP5854



2-3. No video signals available at the DVD/HD input circuit

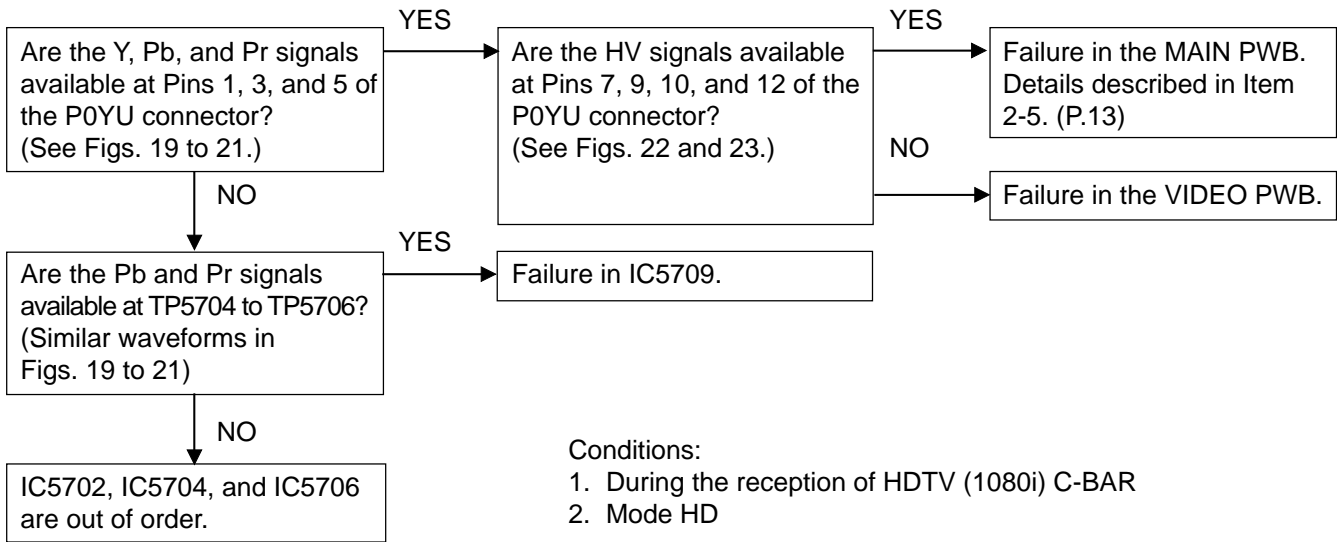


Fig. 19 Signal Y
Pins 1 of Connector P0YU ; 1.3Vpp



Fig. 20 Signal Pb
Pin 3 of Connector P0YU ; 1Vpp



Fig. 21 Signal Pr
Pin 5 of Connector P0YU ; 1Vpp



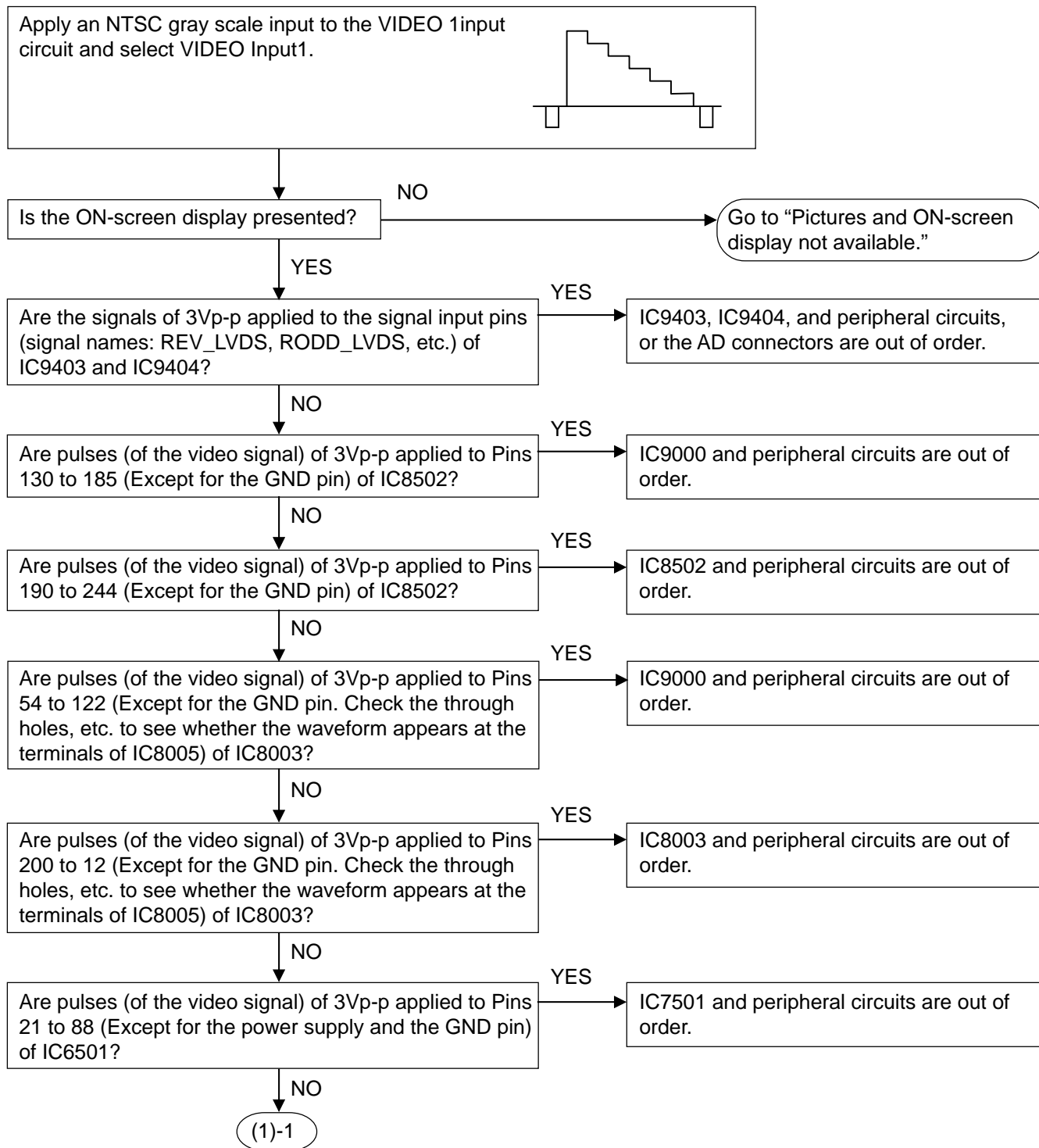
Fig. 22 Horizontal Sync Signals
Pins 7 and 10 of Connector P0YU ; 5Vpp

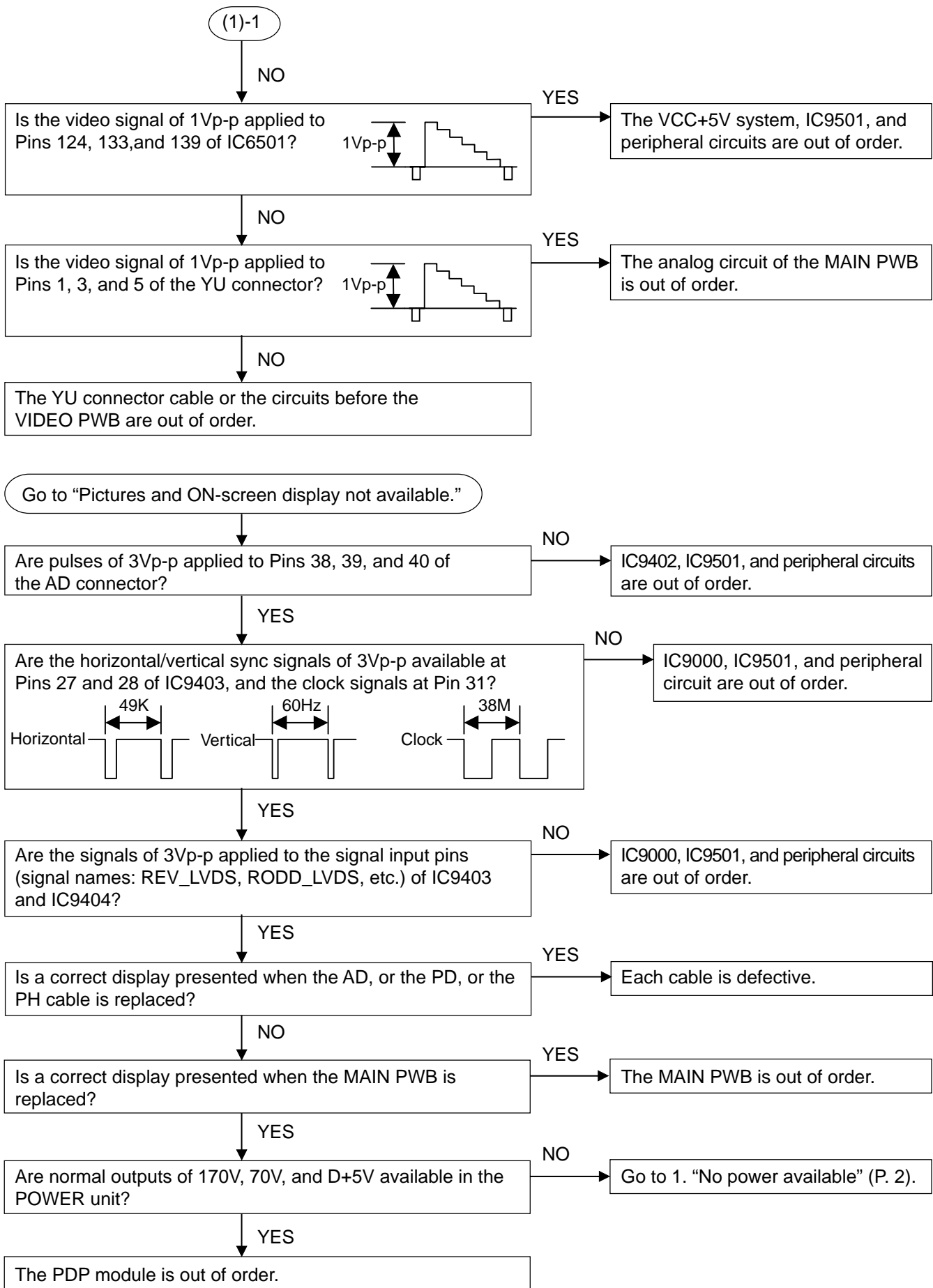


Fig. 23 Vertical Sync Signals
Pins 9 and 12 of Connector P0YU ; 5Vpp

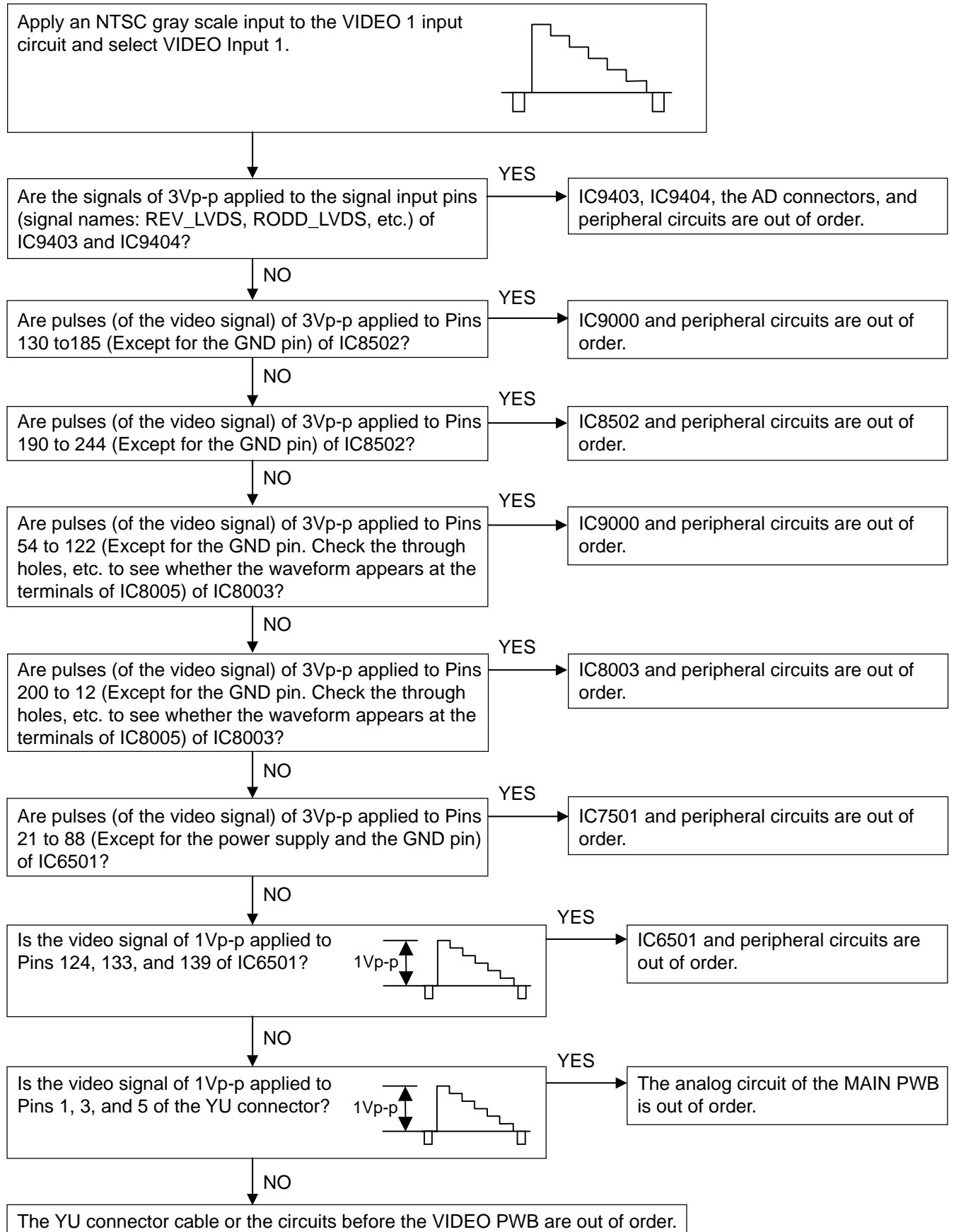


2-4. No video pictures available even with any input selection

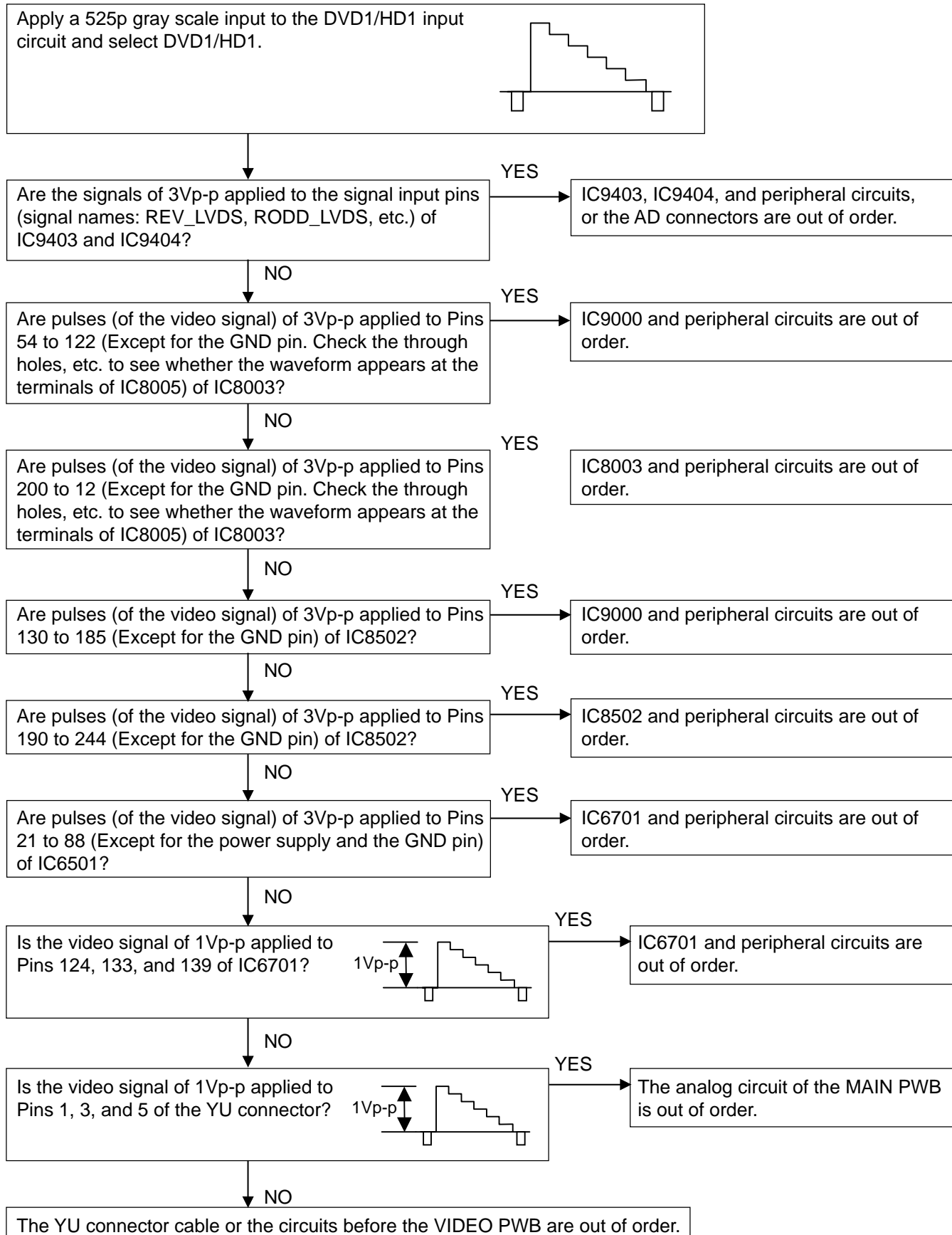




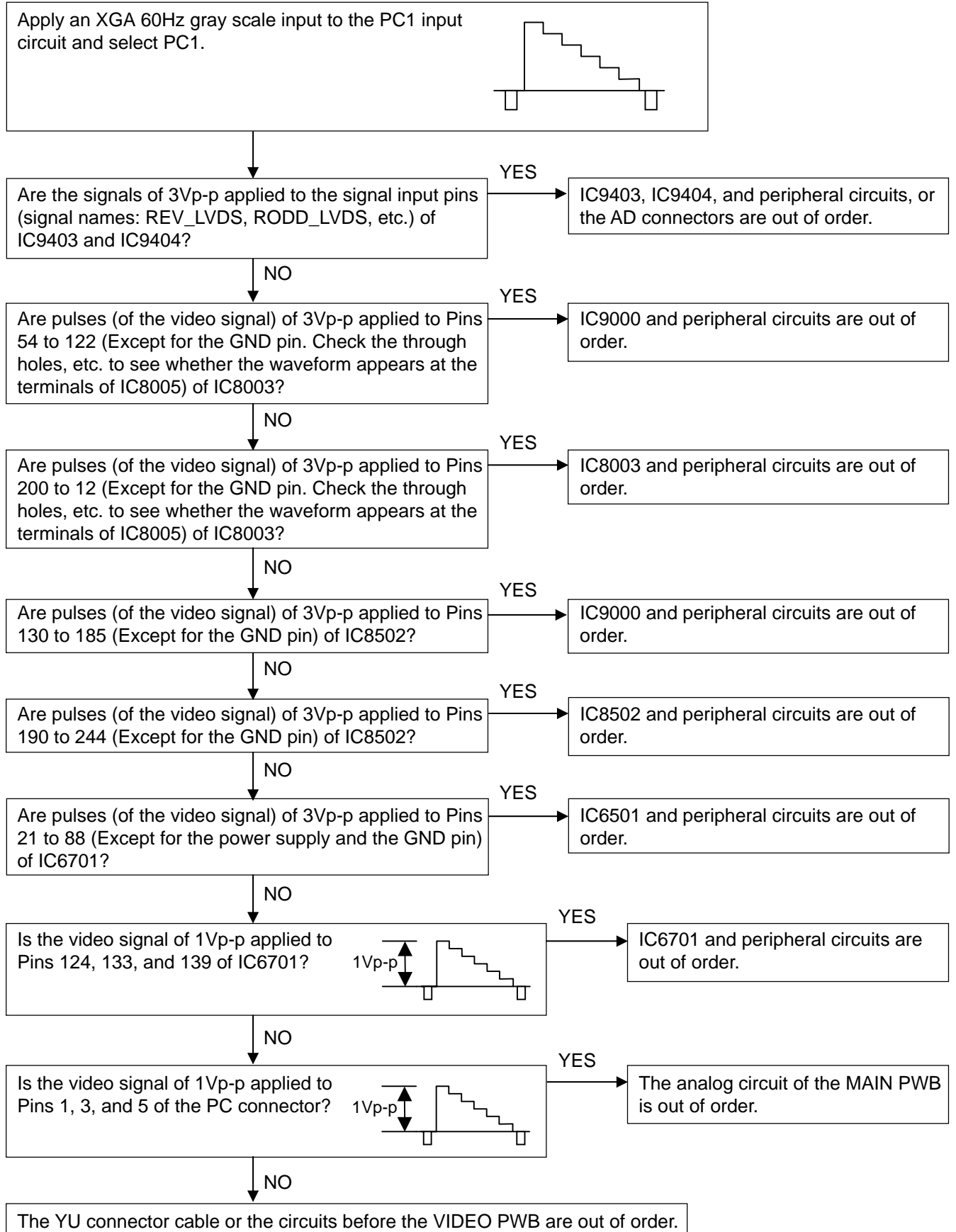
2-5. No interlace motion pictures generated for VIDEO, DVD, HDTV, etc.



2-6. No progressive motion pictures generated



2-7. No still pictures of PC, etc. generated



METHOD OF ADJUSTMENTS

METHOD OF ADJUSTMENTS

Adjustments should be carried out in accordance with the procedures described below. However, any adjustments other than the items A to C below are not required.

- A. When the PDP module is replaced, adjust the sections according to the adjusting items 1 to 3 specified below.
- B. When the power unit is replaced, adjust the sections according to the adjusting items 1 to 3 specified below.
- C. When the MAIN PWB or the VIDEO PWB is replaced, adjust the sections according to the adjusting item 4 specified below.

(CAUTION) When you exchange PDP module, please be sure to clear integrated time to "0" by the following "How to clear the integrated time".

* **How to clear the integrated time**

Assume the following factory mode by the use of the remote control. Press "PROCEED" key six times to get the screen of "USAGE TIME". In this state, the integrated time up to the present time is displayed.

The integrated time is cleared to "0" when the remote control keys are pressed in the order of "MUTE" → POSITION "UP" → POSITION "DOWN" → "OFF TIMER".

* How to enter or withdraw from the factory setting mode:

Press the keys in the sequential order of [OFF TIMER] → [EXIT] → [MUTE] → [OFF TIMER].

When a conventional remote control is used:

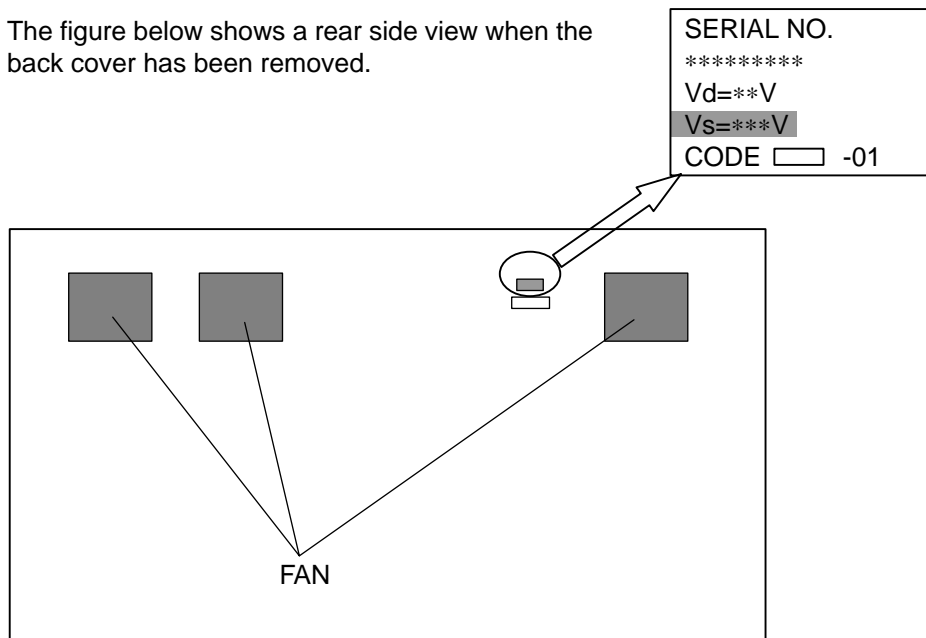
Press the keys in the sequential order of [OFF TIMER] → [OK] → [MUTE] → [OFF TIMER].

At that time, use the [MENU] key in place of the [PROCEED] key.

1. Adjustment of +170V

- (1) Using any video signal of VIDEO input, DVD/HD input, or RGB input, and display a color bar signal. Turn on the power switch of the main unit.
- (2) Turn the volume control (RV4) in the [+170V ADJ] section of the power unit, and adjust the voltage value between TP3 (+170V output) and TP4 (GND) of the power unit so that this voltage settles within the range of "specified voltage of the PDP module (Value Vs on the label shown below) ± 1V."

(Caution) The figure below shows a rear side view when the back cover has been removed.



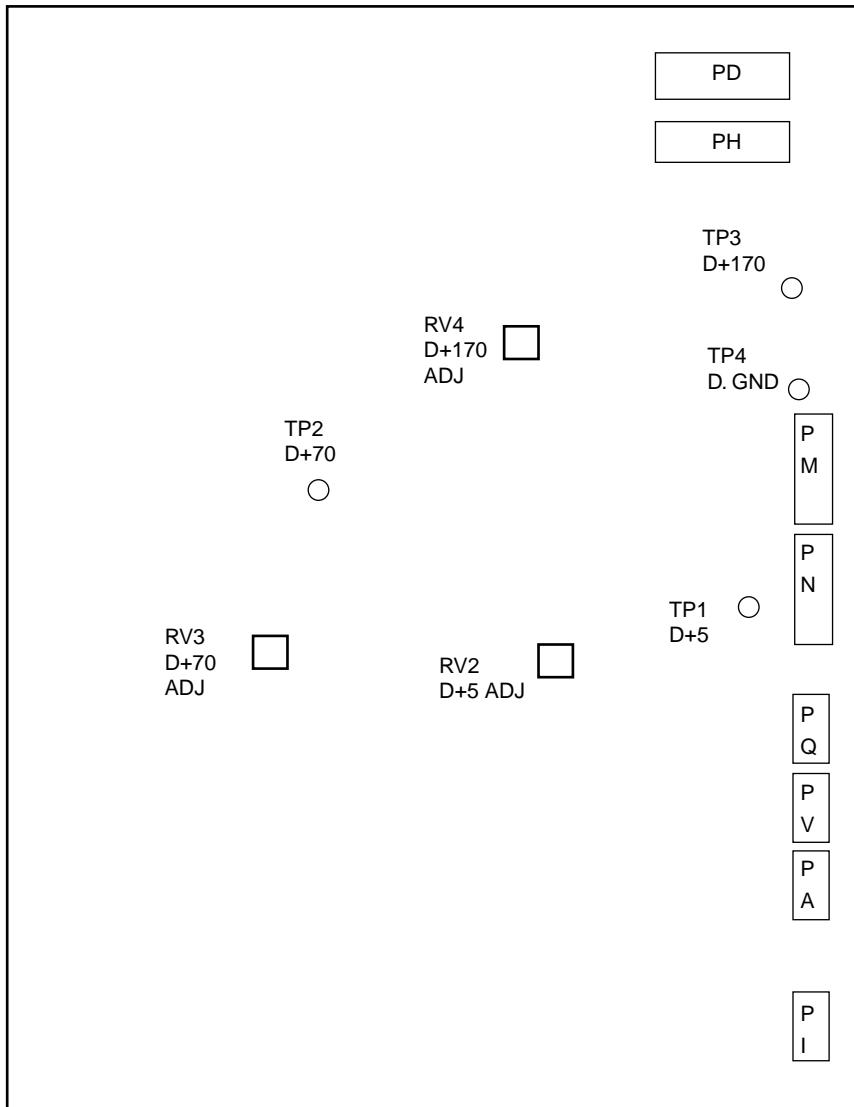
2. Adjustment of +70V

- (1) Using any video signal of VIDEO input, DVD/HD input, or RGB input, and display a color bar signal. Turn on the power switch of the main unit.
- (2) Confirm that the voltage value between TP2 (+70V output) and TP4 (GND) of the power unit is maintained at " $70 \pm 1V$."
Otherwise, turn the volume control (RV3) in the [D+70V ADJ] section so that the voltage value is maintained at " $70 \pm 1V$."

3. Adjustment of +5V

- (1) Use any video signal of VIDEO input, DVD/HD input, or RGB input, and display a color bar signal.
- (2) Confirm that the voltage value between TP1 (+5V output) and TP4 (GND) of the power unit is maintained at " $5.1 \pm 0.1V$."
Otherwise, turn the volume control (RV2) in the [+5V ADJ] section so that the voltage value is maintained at " $5.1 \pm 0.1V$."

* POWER unit layout



4. Screen position and phase adjustment

Adjustment of the range of horizontal display presented at the PDP module

Adjustment of the range of vertical display presented at the PDP module

Adjustment of the signal position in horizontal direction within the H POS display range

Adjustment of the signal position in vertical direction within the V POS display range

4-1. Adjustment of the VIDEO screen position

Make correct adjustments of the display range with [MHPOS] and [MVPOS].

- (1) Enter an input of NTSC monoscopic signal in the VIDEO input terminal.
- (2) Select the VIDEO input by the use of the relevant key of the remote control or the CTL PWB.
- (3) Enter the factory shipment setting mode by using the factory shipment control command of the remote control.
- (4) Press the [PROCEED] key to obtain the [POSITION] screen.
- (5) Press the [WIDE] key to select the [STADIUM] mode. ([STADIUM] mode in the initial state)
- (6) In case of any deviation from the display range of the PDP module, press the cursor key [^] or [v] of the remote control to select [MHPOS] or [MVPOS]. Press the cursor key [<] or [>] for adjustments.
- (7) Press the cursor key [^] or [v] of the remote control to select [H POS].
- (8) Press the cursor key [<] or [>] for adjustments so that the right and left are balanced.
- (9) Press the cursor key [^] or [v] of the remote control to select [V POS].
- (10) Press the cursor key [<] or [>] for adjustments so that the upper and lower are balanced.
- (11) Confirm that [H PHA] is maintained at 0.
- (12) Confirm that [H CLK] is maintained at 0.
- (13) In the same manner, press the [WIDE] key to select the [ZOOM] mode, the [NORMAL] mode, or the [FULL] mode. Adjust the horizontal and vertical positions, and confirm that [H PHA] and [H CLK] are maintained at 0, respectively.
- (14) Change the input signal to the PAL monoscopic signal and repeat the steps of (4) to (14) above.
- (15) Withdraw from the factory mode.

4-2. Adjustment of the DVD/HD screen position

Make correct adjustments of the display range with [MHPOS] and [MVPOS].

- (1) Enter an input of HDTV monoscopic signal in the DVD/HD input terminal. According to the "convenient functional setting" in the [MENU] screen, press the cursor key [^] or [v] of the remote control to confirm that [HD SELECT] has been set at [1035i].
- (2) Select the HD input by the use of the relevant key of the remote control or the CTL PWB.
- (3) Enter the factory shipment setting mode by using the factory shipment control command of the remote control.
- (4) Press the [PROCEED] key to obtain the [POSITION] screen.
- (5) In case of any deviation from the display range of the PDP module, press the cursor key [^] or [v] of the remote control to select [MHPOS] or [MVPOS]. Press the cursor key [<] or [>] for adjustments.
- (6) Press the cursor key [^] or [v] of the remote control to select [H POS].
- (7) Press the cursor key [<] or [>] for adjustments so that the right and left are balanced.
- (8) Press the cursor key [^] or [v] of the remote control to select [V POS].
- (9) Press the cursor key [<] or [>] for adjustments so that the upper and lower are balanced.
- (10) Confirm that [H PHA] is maintained at 0.
- (11) Confirm that [H CLK] is maintained at 0.
- (12) Change the input video signal to the NTSC component signal and repeat the steps of 1-1 (3) to (11) above.
- (13) Change the input video signal to the DTV 1080i signal and repeat the steps of 1-1 (3) to (11) above.
- (14) Change the input video signal to the DTV 1080i signal. Press the cursor key [<] or [>] of the remote control to select [1080B] for [HDS] of the screen. Repeat the steps of 1-1 (3) to (11) above. Return [HDS] to [1080i].
- (15) Change the input video signal to the DTV 720P signal and repeat the steps of 1-1 (3) to (11) above.
- (16) Change the input video signal to the DTV 480P signal and repeat the steps of 1-1 (3) to (11) above.
- (17) Withdraw from the factory shipment setting mode.

[Morgue]

1. Signal Generator

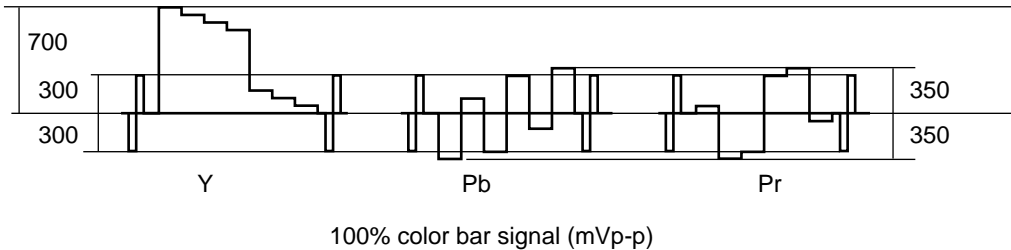
- (1) Digital RGB and component signal generator
 - Equivalent to the Video Generator LT1615 (made by LEADER)
 - Equivalent to the Panel Adapter LT9217 (made by LEADER)
 - Equivalent to the Video Encoder LT1606 (made by LEADER)
- (2) NTSC signal generator
 - Equivalent to the NTSC Pattern Generator LCG-403YC (made by LEADER)
- (3) PAL signal generator
 - Equivalent to the Color Bar Pattern Generator PM5518 (made by PHILIPS)

2. VIDEO input

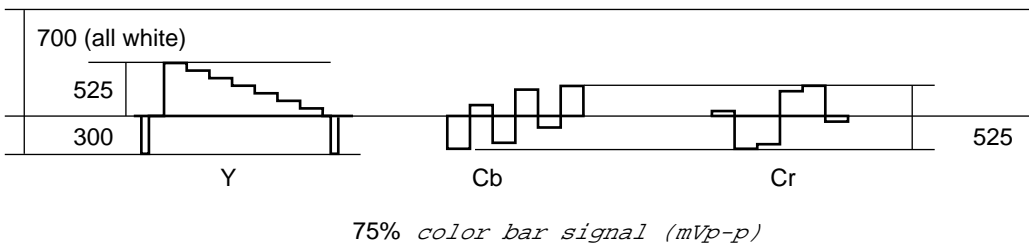
Input: Composite video input or S-terminal input for one system

3. DVD/HD/DTV input

3-1. HD: Y/Pb/Pr component input, tri-sync signal

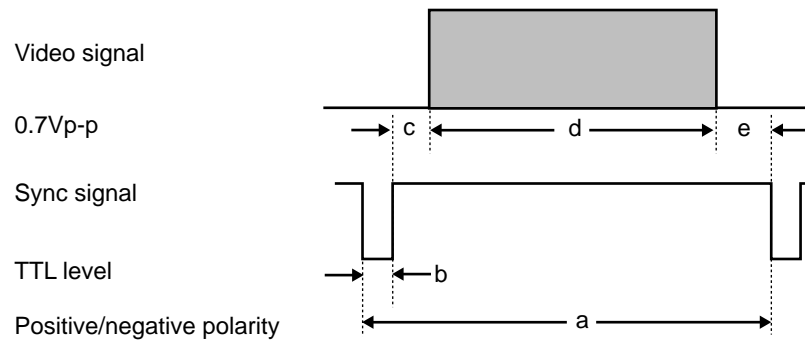


3-2. DVD: Y/B-Y/R-Y component input
(HD/DVD in common)

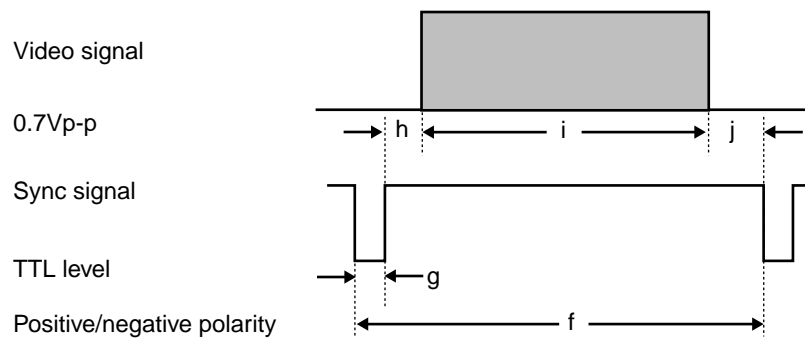


4. RGB/PC input

1) Horizontal sync period



(2) Vertical sync period



* The data a to j above are specified in the next page and thereafter, classified for various inspection signals.

5. RGB/PC signal timing table

PC mode	1	2	3	4	5
Signal name	VU-6010 NTSC	VU-6010 PAL/SECAM	PC98 400@56Hz	IBM 400@70Hz	PC98 480@60HZ
Definition	640*240	768*288	640*400	640*400	640*480
Dot clock frequency (MHz)	12.214	14.752	21.053	25.175	25.175
H frequency (kHz)	15.734	15.557	24.826	31.469	31.469
V frequency (Hz)	59.94	50.39	56.423	70.086	59.94
H total (uS)	63.534	64.262	40.285	31.778	31.778
(dots)	776	948	848	800	800
H display period (uS)	52.4	52.06	30.4	25.422	25.422
(dots)	640	768	640	640	640
H front porch (uS)	1.146	1.288	2.803	0.675	0.596
(dots)	14	19	59	17	15
H sync pulse width (uS)	8.76	8.677	3.04	2.542	3.813
(dots)	107	128	64	64	96
H back porch (uS)	1.228	2.237	4.037	3.138	1.946
(dots)	15	33	85	79	49
V total (mS)	16.652	20.055	17.723	14.268	16.683
(line)	262	312	440	449	525
V display period (mS)	15.3	18.513	16.112	12.711	15.253
(line)	240	288	400	400	480
V front porch (mS)	0.191	0.321	0.282	0.413	0.191
(line)	3	5	7	13	6
V sync pulse width (mS)	1.144	1.093	0.322	0.064	0.064
(line)	18	17	8	2	2
V back porch (mS)	0.064	0.064	1.007	1.08	1.176
(line)	1	1	25	34	37
H sync polarity	Neg	Neg	Neg	Neg	Neg
V sync polarity	Neg	Neg	Neg	Neg	Neg
Scan type	Interlaced	Interlaced	Non Interlaced	Non Interlaced	Non Interlaced

PC mode	6	7	8	9	10
Signal name	MAC@13"	VESA 480@72Hz	VESA 480@75Hz	VESA 480@85Hz	XGA-2 480@75Hz
Definition	640*480	640*480	640*480	640*480	640*480
Dot clock frequency (MHz)	30.24	31.5	31.5	36.0	31.5
H frequency (kHz)	35	37.861	37.5	43.269	39.375
V frequency (Hz)	66.667	72.809	75	85.008	75
H total (uS)	28.571	26.413	26.667	23.111	25.4
(dots)	864	832	840	832	800
H display period (uS)	21.164	20.317	20.317	17.778	20.32
(dots)	640	640	640	640	640
H front porch (uS)	2.116	0.762	0.508	1.556	0.508
(dots)	64	24	16	56	16
H sync pulse width (uS)	2.116	1.27	2.032	1.556	3.048
(dots)	64	40	64	56	96
H back porch (uS)	3.175	4.064	3.81	2.222	1.524
(dots)	96	128	120	80	48
V total (mS)	15	13.735	13.333	11.764	13.333
(line)	525	520	500	509	525
V display period (mS)	13.714	12.678	12.8	11.093	12.19
(line)	480	480	480	480	480
V front porch (mS)	0.086	0.237	0.027	0.023	0.279
(line)	3	9	1	1	11
V sync pulse width (mS)	0.086	0.079	0.08	0.069	0.051
(line)	3	3	3	3	2
V back porch (mS)	1.114	0.739	0.427	0.578	0.813
(line)	39	28	16	25	32
H sync polarity	Sync on G	Neg	Neg	Neg	Neg
V sync polarity	Sync on G	Neg	Neg	Neg	Neg
Scan type	Non Interlaced	Non Interlaced	Non Interlaced	Non Interlaced	Non Interlaced

PC mode	11	12	13	14	15
Signal name	VESA 600@56Hz	VESA 600@60Hz	VESA 600@72Hz	VESA 600@75Hz	VESA 600@85Hz
Definition	800*600	800*600	800*600	800*600	800*600
Dot clock frequency (MHz)	36	40	50	49.5	56.25
H frequency (kHz)	35.156	37.879	48.077	46.875	53.674
V frequency (Hz)	56.25	60.317	72.188	75	85.061
H total (uS)	28.444	26.4	20.8	21.333	18.631
(dots)	1024	1056	1040	1056	1048
H display period (uS)	22.222	20	16	16.162	14.222
(dots)	800	800	800	800	800
H front porch (uS)	0.667	1	1.12	0.323	0.569
(dots)	24	40	56	16	32
H sync pulse width (uS)	2	3.2	2.4	1.616	1.138
(dots)	72	128	120	80	64
H back porch (uS)	3.556	2.2	1.28	3.232	2.702
(dots)	128	88	64	160	152
V total (mS)	17.778	16.579	13.853	13.333	11.756
(line)	625	628	666	625	631
V display period (mS)	17.067	15.84	12.48	12.8	11.179
(line)	600	600	600	600	600
V front porch (mS)	0.028	0.026	0.77	0.021	0.019
(line)	1	1	37	1	1
V sync pulse width (mS)	0.057	0.106	0.125	0.064	0.056
(line)	2	4	6	3	3
V back porch (mS)	0.626	0.607	0.478	0.448	0.503
(line)	22	23	23	21	27
H sync polarity	Pos.	Pos.	Pos.	Pos.	Pos.
V sync polarity	Pos.	Pos.	Pos.	Pos.	Pos.
Scan type	Non Interlaced	Non Interlaced	Non Interlaced	Non Interlaced	Non Interlaced

PC mode	16	17	18	19	20
Signal name	MAC@16"	I/O dater wide	CEREB wide 1	VESA wide (NEC 1)	VESA wide (NEC 2)
Definition	832*624	852*480	864*480	848*480	1024*576
Dot clock frequency (MHz)	57.2832	34.006	42.526	33.75	47.25
H frequency (kHz)	49.725	31.722	37.5	31.02	35.795
V frequency (Hz)	74.55	59.966	75	60	60.059
H total (uS)	20.111	31.524	26.667	32.237	27.937
(dots)	1152	1072	1134	1088	1320
H display period (uS)	14.524	25.055	20.317	25.126	21.672
(dots)	832	852	864	848	1024
H front porch (uS)	0.559	0.659	0.508	0.474	0.339
(dots)	32	22	22	16	16
H sync pulse width (uS)	1.117	3.764	2.032	3.319	3.048
(dots)	64	128	86	112	144
H back porch (uS)	3.91	2.047	3.81	3.319	2.878
(dots)	224	70	162	112	136
V total (mS)	13.414	16.676	13.333	16.667	16.65
(line)	667	529	500	517	596
V display period (mS)	12.549	15.132	12.8	15.474	16.091
(line)	624	480	480	480	576
V front porch (mS)	0.02	0.378	0.027	0.193	0.056
(line)	1	12	1	6	2
V sync pulse width (mS)	0.06	0.095	0.08	0.258	0.112
(line)	3	3	3	8	4
V back porch (mS)	0.784	1.072	0.427	0.741	0.391
(line)	39	34	16	23	14
H sync polarity	Sync on G	Neg	Pos.	Pos.	Pos.
V sync polarity	Sync on G	Neg	Neg	Pos.	Pos.
Scan type	Non Interlaced	Non Interlaced	Non Interlaced	Non Interlaced	Non Interlaced

PC mode	21	22	23	24	25
Signal name	VESA wide (NEC 3)	VESA wide (NEC 4)	CEREB wide 2	VESA 768@60Hz	VESA 768@70Hz
Definition	1280*720	1360*768	1024*600	1024*768	1024*768
Dot clock frequency (MHz)	76.5	85.5	51.2	65	75
H frequency (kHz)	45.106	47.712	37.879	48.363	56.476
V frequency (Hz)	60.142	60.015	60.317	60.004	70.069
H total (uS)	22.17	20.959	26.4	20.677	17.707
(dots)	1696	1792	1352	1344	1328
H display period (uS)	16.732	15.906	20	15.754	13.653
(dots)	1280	1360	1024	1024	1024
H front porch (uS)	0.627	0.749	1	0.369	0.32
(dots)	48	64	51	24	24
H sync pulse width (uS)	2.301	1.310	3.2	2.092	1.813
(dots)	176	112	164	136	136
H back porch (uS)	2.51	2.994	2.2	2.462	1.92
(dots)	192	256	113	160	144
V total (mS)	16.627	16.662	15.579	16.666	14.272
(line)	750	795	628	806	806
V display period (mS)	15.962	16.097	15.84	15.88	13.599
(line)	720	768	600	768	768
V front porch (mS)	0.089	0.063	0.026	0.062	0.053
(line)	4	3	1	3	3
V sync pulse width (mS)	0.177	0.126	0.106	0.124	0.106
(line)	8	6	4	6	6
V back porch (mS)	0.399	0.377	0.607	0.6	0.513
(line)	18	18	23	29	29
H sync polarity	Pos.	Pos.	Neg	Neg.	Neg.
V sync polarity	Pos.	Pos.	Pos.	Neg.	Neg.
Scan type	Non Interlaced	Non Interlaced	Non Interlaced	Non Interlaced	Non Interlaced

PC mode	26	27	28	29	30
Signal name	VESA 768@75Hz	VESA 768@85Hz	MAC@19"	VESA 1024@60Hz	VESA 1024@75Hz
Definition	1024*768	1024*768	1024*768	1280*1024	1280*1024
Dot clock frequency (MHz)	78.75	94.5	80	108	135
H frequency (kHz)	60.023	68.677	60.24	63.981	79.976
V frequency (Hz)	75.029	84.997	74.93	60.02	75.025
H total (uS)	16.66	14.561	16.600	15.63	12.501
(dots)	1312	1376	1328	1688	1688
H display period (uS)	13	10.836	12.8	11.852	9.481
(dots)	1024	1024	1024	1280	1280
H front porch (uS)	0.203	0.508	0.4	0.444	0.119
(dots)	16	48	32	48	2
H sync pulse width (uS)	1.219	1.016	1.2	1.037	1.067
(dots)	96	96	96	112	144
H back porch (uS)	2.235	2.201	2.2	2.296	1.837
(dots)	176	208	176	248	248
V total (mS)	13.328	11.765	13.347	16.661	13.329
(line)	800	808	804	1066	1066
V display period (mS)	12.795	11.183	12.749	16.005	12.804
(line)	768	768	768	1024	1024
V front porch (mS)	0.017	0.015	0.050	0.016	0.013
(line)	1	1	3	1	1
V sync pulse width (mS)	0.05	0.044	0.050	0.047	0.038
(line)	3	3	3	3	3
V back porch (mS)	0.466	0.524	0.498	0.594	0.475
(line)	28	36	30	38	38
H sync polarity	Pos.	Pos.	—	Pos.	Pos.
V sync polarity	Pos.	Pos.	—	Pos.	Pos.
Scan type	Non Interlaced	Non Interlaced	Non Interlaced	Non Interlaced	Non Interlaced

PC mode	31	32	33	34	35
Signal name	IDC-3000G PAL 625P	IDC-3000G NTSC 525P	HDTV-J	DTV (480P)	DTV (720P)
Definition	768*576	640*480	1920*1034	644*483	1280*720
Dot clock frequency (MHz)	29.687	24.39	74.25	24.37	74.25
H frequency (kHz)	31.389	31.47	33.75	31.469	45.000
V frequency (Hz)	50	59.9	60/60	59.94	60
H total (uS)	31.933	31.775	29.63	31.777	22.222
(dots)	948	775	2200	774	1650
H display period (uS)	25.87	26.24	25.86	26.427	17.239
(dots)	768	640	1920	644	1280
H front porch (uS)	0.269	0.41	0.59	0.75	0.943
(dots)	8	10	44	18	70
H sync pulse width (uS)	2.526	2.46	0.59	2.35	1.077
(dots)	75	60	44	57	80
H back porch (uS)	3.267	2.665	2.59	2.25	2.963
(dots)	97	65	192	55	220
V total (mS)	19.911	16.522	16.652	16.683	16.667
(line)	625	525	562/562	525	750
V display period (mS)	18.35	15.106	15.319	15.348	
(line)	576	480	517/517	483	720
V front porch (mS)	0.223	0.252	0.148	0.191	0.111
(line)	7	8	5	6	5
V sync pulse width (mS)	0.223	0.22	0.148	0.191	0.111
(line)	7	7	5	6	5
V back porch (mS)	1.115	0.944	1.037	0.953	0.444
(line)	35	30	35	30	20
H sync polarity	Neg	Neg	Neg	Neg	Neg
V sync polarity	Neg	Neg	Neg	Neg	Neg
Scan type	Non Interlaced	Non linterlaced	Interlaced	Non Interlaced	Non Interlaced

PC mode	36	37	38	39
Signal name	HDTV-W	SSPE	JSPE	MAC@12"
Definition	1920*1080	1024*512	852*480	1152*870
Dot clock frequency (MHz)	74.25	40	16	100
H frequency (kHz)	33.75	33.727	15.75	68.681
V frequency (Hz)	60/60	60.012	59.94	75.062
H total (uS)	29.630	29.650	63.750	14.560
(dots)	2200	1186	1020	1456
H display period (uS)	25.859	25.600	53.250	11.520
(dots)	1920	1024	852	1152
H front porch (uS)	0.593	0.600	1.250	0.320
(dots)	44	24	20	32
H sync pulse width (uS)	1.185	1.200	4.750	1.280
(dots)	88	48	76	128
H back porch (uS)	1.993	2.250	4.500	1.440
(dots)	148	90	72	144
V total (mS)	16.652/16.682	16.663	16.683	13.322
(line)	562/563	562	262.5/262.5	915
V display period (mS)	16.000/16.000	15.15	15.236/15.236	12.667
(line)	540/540	511	239/239	870
V front porch (mS)	0.059/0.074	0.178	0.064/0.096	0.044
(line)	2/2.5	6	1/1.5	3
V sync pulse width (mS)	0.148/0.148	0.148	0.191/0.191	0.044
(line)	5/5	5	3/3	3
V back porch (mS)	0.444/0.459	1.186	1.211/1.243	0.568
(line)	15/15.5	40	19/19.5	39
H sync polarity	Neg	Neg	Neg	Sync on G
V sync polarity	Neg	Neg	Neg	Sync on G
Scan type	Interlaced	Non Interlaced	Interlaced	Non Interlaced

CIRCUIT DESCRIPTION

CIRCUIT DESCRIPTION

(Note) In regard to the contents of the text, please refer also to the relevant circuit diagrams.

■ Power unit block [Including the power-related μ -COM (microcomputer) operation]

- When a commercial power input is fed from an AC inlet, the power unit begins to generate an output of M+7V for the μ -COM system. M+7V is supplied to IC9502 from Pin ① of the PM connector. When the main POWER SW (S2601) is turned ON, M+5V is supplied to the μ -COM (IC9501). With the supply of M+5V, the μ -COM supplies a "POWER" signal to the power unit to actuate it.
- When the [H] input of the "POWER" signal is fed from Pin ③ of the PM connector, RL1 is turned ON to generate power outputs for the signal system (D+5V, D+3.3, A+14V, A+5V, S+13V, S-13V). These power outputs are fed to the respective signaling circuits. After each signaling power supply has been fed (for 200msec or more), the power outputs (D+170V, D+70V) are fed to the HV system, and extended further to the PDP module.
- When the temperature in the power unit attains about 100°C, the T-ALM2 signal begins to feed an "L" signal to the MAIN PWB (μ -COM) from Pin ⑧ of the PN connector. The μ -COM turns the "POWER" signal at the "L" level to turn off the power supply. In this state, the LED flashes in red. (T-ALM1 is not used.)
- When an LVP signal at the "L" level from the PDP module is entered in Pin 37 (MAIN PWB) of the AD connector and in Pin ① (power unit) of the PD connector, the μ -COM turns the "POWER" signal at the "L" level and makes the LED "flash in red and green reciprocally." The power unit turns off all the power supplies other than the M+7V system.
- The POMUTE signal is used to detect AC OFF first of all and supplies an "L" output to Pin ④ of the PM connector. This signal is fed to Pin 93 of the μ -COM and Pin ④ of the AE connector (AUDIO unit). This circuit is used to perceive the occurrence of commercial power OFF due to a service interruption or a certain cause (prevention of misoperation). It is also used for MUTE.

■ VIDEO PWB Block

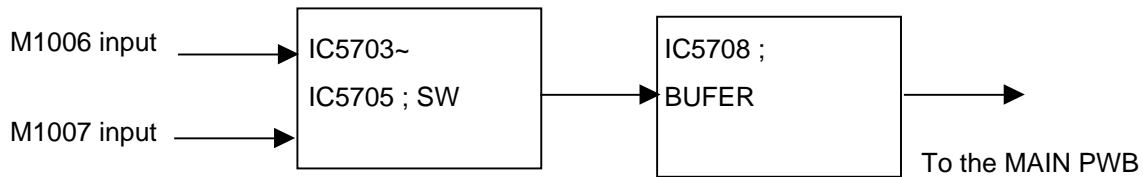
1. AUDIO block

The AUDIO signal input entered from M1008 to M1010 is controlled and selected by I2C bus control of IC5001 (MM1311BD: SW).

The selected AUDIO signal is output from the AB connector to the AUDIO AMP module via IC5002 (BA4558: buffer).

2. PC block

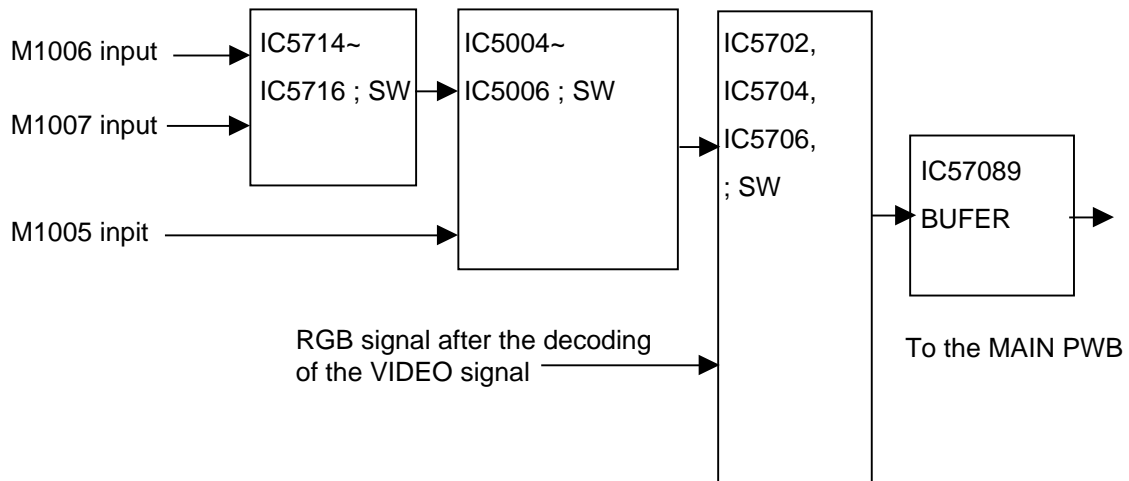
The video signals (RGB signals) from M1006 and M1007 are selected at IC5703, IC5705, and IC5707, and then output to the MAIN PWB via IC5708 (AD8023: buffer) and the PC connector.



3. HD block

The video signals (Y, Pb, Pr signals) from M1006 and M1007 are selected at IC5714 to IC5716. The selected signals are changed over with the signals from M1005 at IC5004 to 5006.

The selected video signals (Y, Pb, Pr signals) are further changed over with the signals on the VIDEO input side at IC5702, 5704, and 5706. The resultant outputs are sent to the MAIN PWB via IC5709 (AD8023; buffer) and the YU connector.



4. VIDEO block

The external VIDEO signal input is entered from M1001 to M1003, and selected at IC5001 (MM1311BD: SW). The composite signals of the IC5001 output are applied to the ternary Y/C separator circuit and the 3-line Y/C separator circuit. The Y/C signal input separated at each Y/C separator circuit is entered in IC5306 to 5309. At the same time, the composite signals are also entered in IC5306 to 5309 directly.

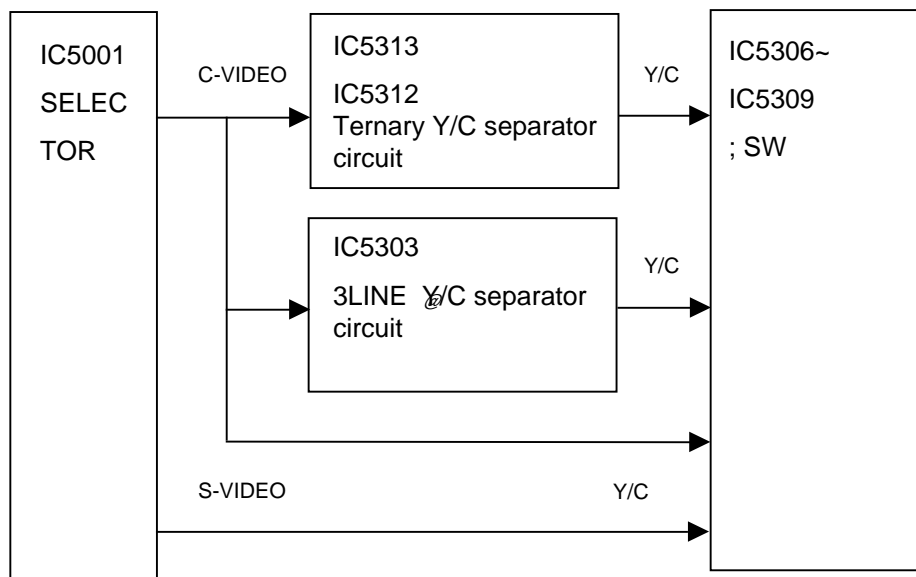
The Y/C signal output of IC5001 is directly entered in IC5306 to 5309.

When the input signal is of 3.58 NTSC, IC5306 to 5309 operate so that only the output of the ternary Y/C separator circuit is turned on.

If the input signal is of PAL/PAL_M,/PAL_N, IC5306 to 5309 operate so that only the output of the 3-line Y/C separator circuit is turned on.

When the input signal is of SECAM, IC5306 to 5309 operate so that the VIDEO composite signal is immediately turned on.

When the VIDEO mode is for VIDEO3 (S input), there is no dependence on the color system and the circuits operate so that the Y/C signal output of IC5001 is always turned on.



(1) Ternary Y/C separation (For NTSC)

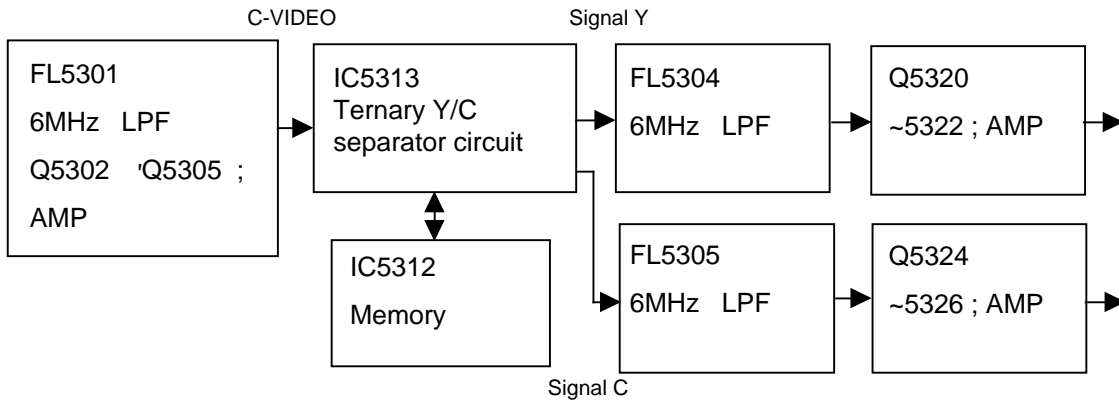
The VIDEO signal output of Q5018 is processed for band limitation at FL5301. It is then processed for the level and Characteristic F compensation at the AMP (Q5302 to Q5305) in the latter stage. After this compensation, the signal input is entered from Q5328 to Pin 88 of IC5313, with the potential maintained at 1.0Vp-p.

The same signal is processed for sync separation at Q5317 to 5319. This sync signal input is then applied to Pin 76 of IC5313.

In IC5313, ternary Y/C separation is effected through an interface with IC5312, and the Y signal is output from Pin 84 of IC5313, and the C signal from Pin 83.

The Y signal is processed for band limitation at FL5304, and the AMP/F characteristic compensation is carried out at Q5320 to Q5322. The resultant signal input is entered in the SW circuit of IC5307.

The C signal is processed for band limitation at FL5305, and the AMP/F characteristic compensation is carried out at Q5324 to Q5326. The resultant signal input is entered in the SW circuit of IC5309.

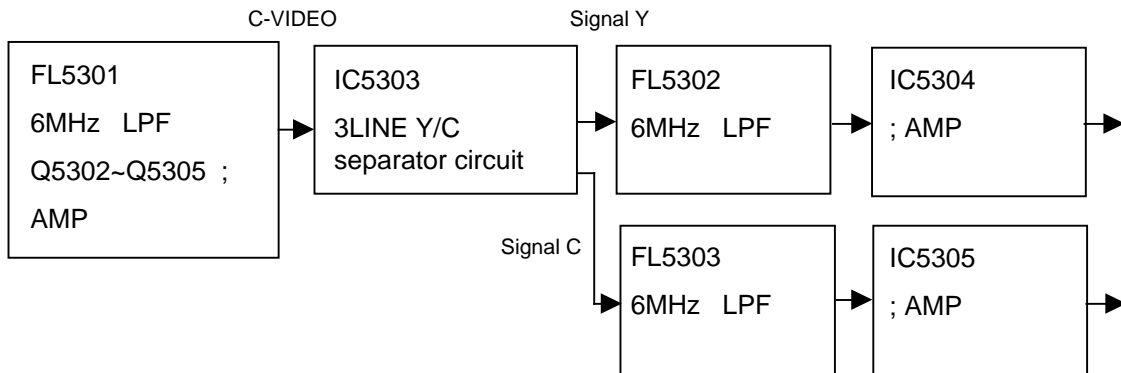


(2) 3-line Y/C separation

The VIDEO signal output of Q5018 is processed for band limitation at FL5301. It is then processed for the level and Characteristic F compensation at the AMP (Q5302 to Q5305) in the latter stage. After this compensation, the signal input is entered from Q5304 to Pin 3 of IC5303, with the potential maintained at 1.3Vp-p.

In IC5303, 3-line Y/C separation is effected, and the Y signal is output from Pin 25, and the C signal from Pin 23.

The Y and C signals are processed for band limitation at FL5302 and 5303, and they are double-amplified at IC5304 and IC5305. The resultant signal input is entered in the SW circuit of IC5307 and IC5309.

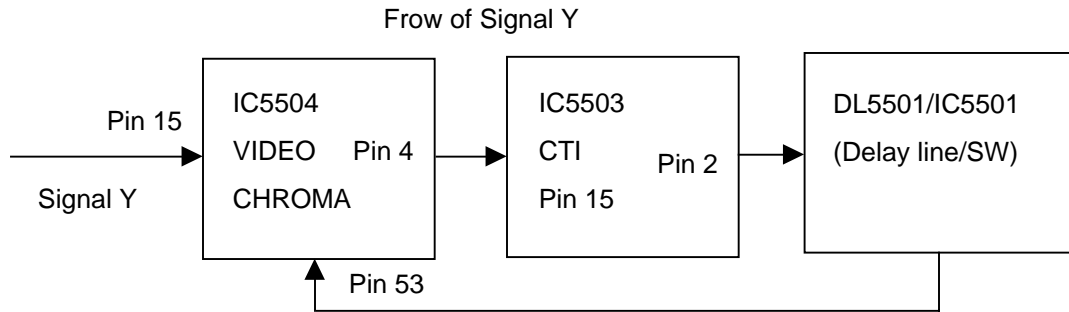


The outputs of IC5306 and IC5307 (Signal Y) are changed over with the DVD signal at IC5507 (TC7W66; SW) of the next stage. The output signal input is directly entered in Pin 17 of IC5504 as a sync signal. Compensation for Character F and peaking are effected at Q5512 to Q5515, and the input is entered in IC5504 (PAL/NTSC process).

The outputs of IC5308 and IC5309 (Signal C) are entered in IC5504 (PAL/NTSC process) and IC5510 (SECAM decoding).

(3) PAL/NTSC decoding

After passing through the built-in delay line of IC5504, the Y signal is then output from Pin 4. This signal is applied to Pin 15 of IC5503 (CTI) and double-amplified there. The resultant output is then generated from Pin 2. The output signal of Pin 2 passes through DL5501 and IC5501, and is then returned to Pin 53 of IC5504. It is further led to the internal RGB matrix through the pedestal clamp, black expander, DC reproduction, sharpness circuit, etc.



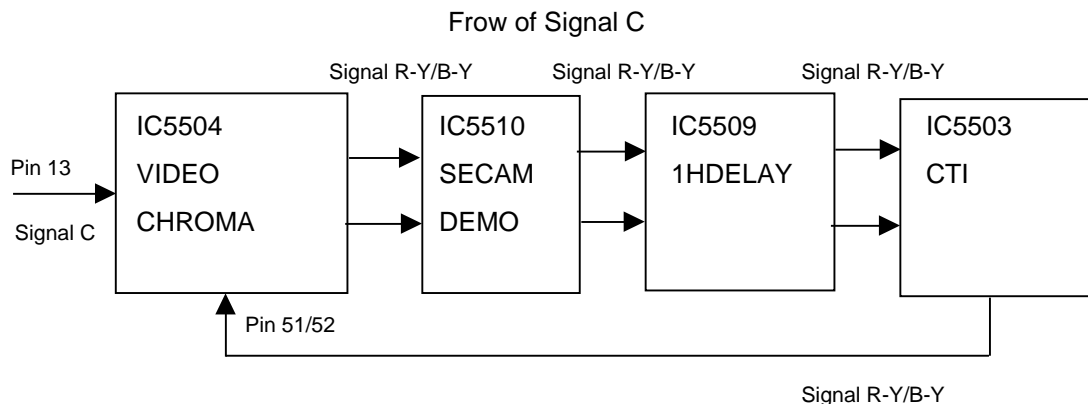
The C signal is processed for system discrimination. When it is defined for the PAL or NTSC, it is then processed through the APC circuit, ACC circuit, carrier reproduction, and the phase detection circuit to make up the R-Y/B-Y signals. The signal output is once generated from Pin 5 and Pin 6, and then entered in Pins 12/13 of IC5510 (SECAM decoding). After passing through the internal switch, the outputs are generated from Pins 10 and 11, and sequentially entered in the next stage.

[In regard to information for system discrimination, the control signal output is generated from Pins 3 and 7 of IC5504, in order to control IC5510 (SECAM decoding) and IC5508 (1H DELAY).]

In IC5508 (1H DELAY), the signal is amplified and its output is generated from Pins 29 and 30. This output is applied to Pins 7 and 8 of IC5503 (CTI).

Internal color processing is conducted in IC5504, and the resultant output is fed to the RGB matrix.

At the RGB matrix stage, this chrominance signal and the foregoing brightness signal are used to generate the analog RGB signal at the RGB matrix stage.



(4) SECAM decoding

When a color signal of SECAM is received, IC5510 (SECAM decoding) receives the control signal from Pin 3 of IC5504 (PAL/NTSC).

Inside the IC5510 (SECAM decoding), the chroma signal input of Pin 24 is processed for band limitation at the bell filter and is then amplified at the limiter circuit. Since then, FM decoding and de-emphasis are carried out. After the signal has been switched with the foregoing control signal, the chrominance output is generated from Pin 10 and Pin 11.

When this signal input is entered in Pins 26/27 of IC5508 (1H DELAY), operation of interpolation is conducted at the intervals of one hour (1H) and the output is generated from Pins 29/30. This output is entered in Pins 7 and 8 of IC5503 (CTI).

In IC5503, profile compensation for the color signals is effected. When the output is generated from Pins 11 and 12, it is then returned to Pins 51 and 52 of IC5504.

(5) 1H DELAY

Information about the color system of received signals is entered from Pin 7 of IC5504 to Pin 24 and Pin 25 of IC5508. According to this information, presence of operation in the internal circuits is examined and AMP gain changeover is carried out.

System	Voltages at Pin 24 and Pin 25 of IC5508
NTSC	0V
PAL	8.3V
SECAM	4.6V

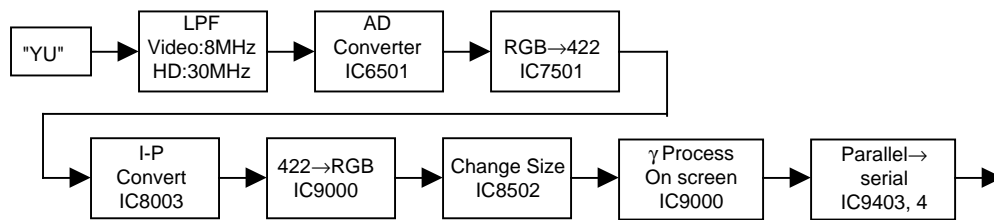
■ MAIN PWB Block

1. Video signal processor block

In the MAIN PWB, each video signal selected at the VIDEO PWB is converted into a digital signal for the purpose of various signal processing such as enlargement, contraction, and so on. The processed signal output is sent to the plasma display module.

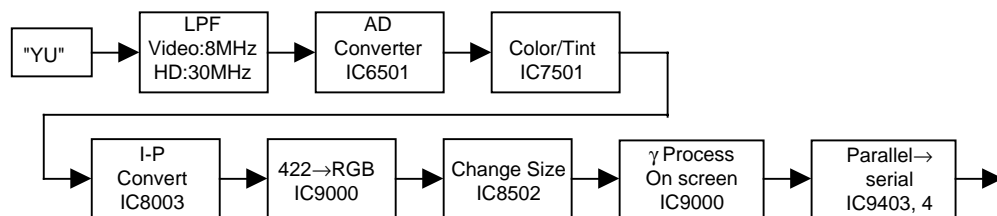
The contents of signal flow control and IC processing for analog signal inputs are different from those for digital signal inputs (RGB3). In addition, for the respective analog signal inputs, the flow of signals can differ according to the type of an input signal.

(1) Flow of video signals, video (for RGB inputs), HDTV (for RGB inputs) signals



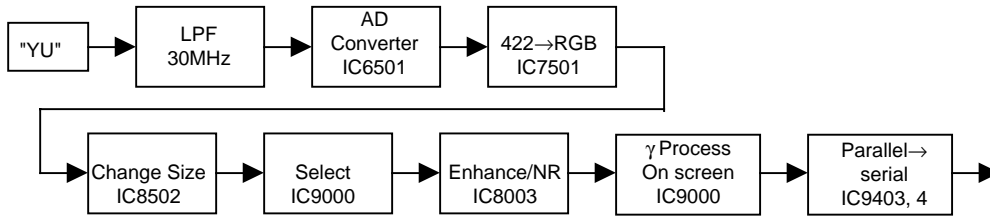
The RGB signal input entered from the YU connector is converted into a digital signal at the AD converter, IC6501. (Processing of RGB x 8 bits x 2 phases = 48 lines) IC7501 is used to convert an RGB signal into a chrominance (422) signal. In IC8003, a horizontal interlace signal of 15 kHz (34 kHz) is converted into a progressive signal of 31 kHz (67 kHz). IC8502 is in charge of screen size conversion for normal size, full size, digital zoom, etc. The processed signal inputs are entered in IC9000 again. In this IC9000, γ processing, gradation processing, and white balance processing are carried out for digital video signals. In addition, the synthesis of ON-screen signals is carried out there. In IC9003 and IC9004, 48-bit parallel signals are processed for conversion into LVDS serial signals and the output is sent to the plasma display module ("AD" connector).

(2) Flow of DVD and HDTV (chrominance input) signals



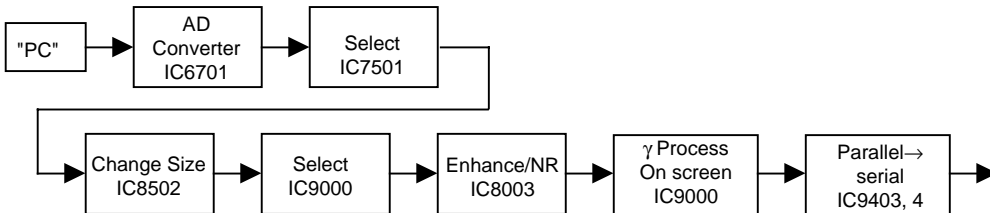
The chrominance signal input entered from the YU connector is converted into a digital signal at the AD converter, IC6501. (Processing of YUV x 8 bits x 2 phases = 48 lines) IC7501 is used for the processing of color depth and tone. In IC8003, a horizontal interlace signal of 15 kHz (33 kHz) is converted into a progressive signal of 31 kHz (67 kHz). In IC9000, the chrominance signal is converted into the RGB signal. IC8502 is in charge of screen size conversion for normal size, full size, digital zoom, etc. The processed signal inputs are entered in IC9000 again. In this IC9000, γ processing, gradation processing, and white balance processing are carried out for digital video signals. In addition, the synthesis of ON-screen signals is carried out there. In IC9003 and IC9004, 48-bit parallel signals are processed for conversion into LVDS serial signals and the output is sent to the plasma display module ("AD" connector).

(3) Flow of 480P, 720P (chrominance input), and 480P, 720P (RGB input) signals



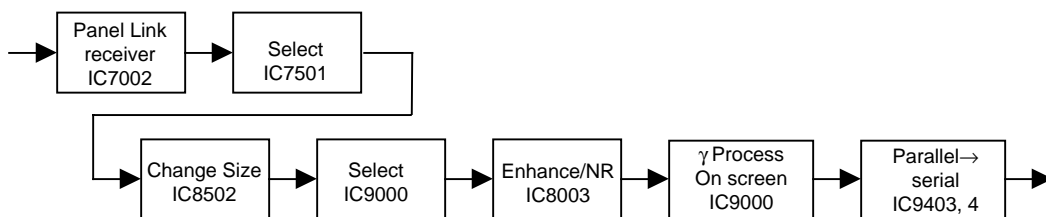
The chrominance (or RGB) signal input entered from the YU connector is converted into a digital signal at the AD converter, IC6501. (Processing of YUV or RGB x 8 bits x 2 phases = 48 lines) IC7501 is used for the processing of color depth and tone for the chrominance (422) signal and the resultant signal is converted into an RGB signal. The RGB signal is once put into chrominance conversion for the processing of color depth and tone. Since then, the signal is again converted into an RGB signal. IC8502 is in charge of screen size conversion for normal size, full size, digital zoom, etc. IC9000 sends out an output signal of IC8502 to IC8003. This IC8003 is in charge of enhancer processing and NR processing. The processed signal input is entered in IC9000 again. In this IC9000, γ processing, gradation processing, and white balance processing are carried out for digital video signals. In addition, the synthesis of ON-screen signals is also carried out there. In IC9003 and IC9004, 48-bit parallel signals are processed for conversion into LVDS serial signals and the output is sent to the plasma display module (“AD” connector).

(4) Flow of RGB1/2 (analog RGB) signals



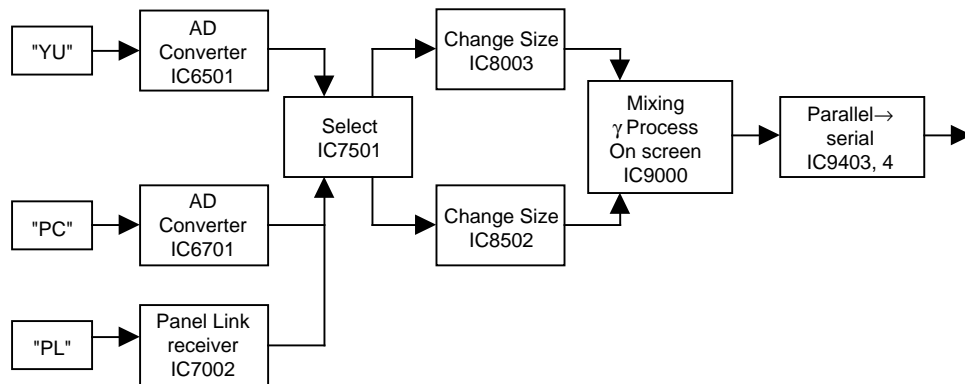
The RGB signal input entered from the PC connector is converted into a digital signal at the AD converter, IC6701. (Processing of RGB x 8 bits x 2 phases = 48 lines) IC7501 sends out an output signal of IC6701 to IC8502. IC8502 is in charge of screen size conversion for normal size, full size, digital zoom, etc. IC9000 sends out an output signal of IC8502 to IC8003. This IC8003 is in charge of enhancer processing and NR processing. The processed signal input is entered in IC9000 again. In this IC9000, γ processing, gradation processing, and white balance processing are carried out for digital video signals. In addition, the synthesis of ON-screen signals is also carried out there. In IC9003 and IC9004, 48-bit parallel signals are processed for conversion into LVDS serial signals and the output is sent to the plasma display module (“AD” connector).

(5) Flow of digital signal inputs (RGB3)



When the RGB3 input is entered, the digital RGB signal input from the PL1 connector is of the serial data and it is converted into the parallel data at the panel link receiver, IC7002. (Processing of RGB x 8 bits x 2 phases = 48 lines) IC7501 sends out an output signal of IC7002 to IC8502. This IC8502 is in charge of screen size conversion for normal size, full size, digital zoom, etc. IC9000 sends out an output signal of IC8502 to IC8003. This IC8003 is in charge of enhancer processing and NR processing. The processed signal input is entered in IC9000 again. In this IC9000, γ processing, gradation processing, and white balance processing are carried out for digital video signals. In addition, the synthesis of ON-screen signals is also carried out there. In IC9003 and IC9004, 48-bit parallel signals are processed for conversion into LVDS serial signals and the output is sent to the plasma display module ("AD" connector).

(6) Flow of dual screen display signals



The chrominance (or RGB) signal input entered from the YU connector is converted into a digital signal at the AD converter, IC6501. The RGB signal input entered from the PC connector is converted into a digital signal at the AD converter, IC6701. In IC7501, the output signal from IC6501 is adjusted to obtain adequate color depth and tone, and the output is sent to IC8003. In IC8003 and IC8502, screen size conversion is carried out for the dual screen display. IC9000 sends out an output signal of IC8502 to IC8003. This IC8003 is in charge of enhancer processing and NR processing. The processed signal input is entered in IC9000 again. In this IC9000, processing of dual screen display is conducted through the synthesis of output signals from IC8003 and IC8502. In addition, γ processing, gradation processing, and white balance processing are carried out for digital video signals. The synthesis of ON-screen signals is also carried out there. In IC9003 and IC9004, 48-bit parallel signals are processed for conversion into LVDS serial signals and the output is sent to the plasma display module ("AD" connector).

(7) Analog filter block

Before the digital conversion at the AD converter, the video signals pass through the low pass filter (LPF). Signals of motion pictures for video, HDTV, etc., pass through an LPF of 8 MHz or 30 MHz. Each switching IC (IC6005, IC6006, IC6007) is selected according to the type of signals and the output is entered in the AD converter, IC6501. The PC signal is led through a 50MHz LPF, or otherwise, it is selected for each input signal by each switching IC (IC6008, IC6009, IC6010, IC6011, IC6012, IC6013). The resultant input is entered in the AD converter, IC6701. The signal intended to select a signal is output from the I/O extension IC, IC6003. IC6003 is controlled by the I2C bus SCL2 and SDA2 from the microcomputer IC9501.

(8) AD converter (IC6501, IC6701) block

IC6501 and IC6701 are the ICs intended for the conversion of analog RGB signals into 8-bit digital signals. (However, there are 48 output lines in total, each RGB color 8 bits x 2.) In addition to the functions of AD converter, this type of IC is also provided with the various functions of analog amplifier and PLL/VCO. Each function is controlled by the I2C bus SCL6 and SDA6 from IC9501.

IC6501 accepts signal inputs of motion pictures such as video signals, DVD, HDTV, etc. IC6701 picks up RGB signal inputs of still pictures from PC, etc.

With the aid of the analog AMP incorporated in the IC, various adjustments are carried out, such as contrast adjustment, brightness adjustment, and white balance adjustment in the factory service mode.

In addition to video signals, the IC receives inputs of horizontal and vertical sync signals. Based on these sync signals, sampling of video signals is conducted by the use of the sampling clock produced in the built-in VCO. The sampling frequency differs according to each signal input entered. The clamp signal (Pin 113) is fed from IC7501.

(9) Panel link block

During the entry of RGB3 input, the digital RGB signal input from the PL1 connector is of serial data, and hence the signal is converted into parallel data at the panel link receiver, IC7002.

While the RGB3 input is not displayed, the microcomputer IC9501 turns the potential of the PD0 terminal (Pin 9) to be at the "L" level to set up a high impedance for the outputs of video signals, clock signals, sync signals, and DE (data enable). If a condition of no signal occurs during the entry of RGB3 input, the SCTD output terminal (Pin 8) is turned to be at the "L" level and this causes the PDO terminal to be at the "L" level, and a condition of high impedance is secured for the outputs. The PDO terminal gains an AND input of the SCTD output and microcomputer output in IC7003.

In IC7004, the Plug & Play data for the panel link (for RGB3 input only) are stored. The power supply and control for IC7004 are maintained from the connected equipment (personal computer, etc.) through the PL connector.

(10) Gate array (Pre G/A IC7501) block

For video signal processing, IC7501 is provided mainly with the four functions specified below. These functions are controlled by bus SIK2, SID2, and CSYUMA from the microcomputer IC9501.

- ① The video signal from the AD converter IC6501/IC6701 or IC7002 is selected according to the type of the input signal, and the output is sent to IC8502 and IC8003.
- ② The RGB signal input from IC6501 is converted into a chrominance signal of 4:4:4 or 4:2:2. The chrominance signal is converted into an RGB signal.
- ③ For the chrominance signal that passes through the IC inside, processing is carried out in regard to the color depth and tone.
- ④ The peak brightness and the mean brightness of the video signal are measured.

(11) I-P conversion and profile emphasis processing, RGB chrominance conversion (IC8003) block

In IC8003, the horizontal 15kHz interlace signals like video signals, DVD signals, etc., are converted into 31kHz progressive signals, and the 33kHz interlace signals of the HDTV system are converted into 67kHz progressive signals. (I-P conversion) In the case of other input signals, processing of profile emphasis and noise reduction is performed. In the case of dual screen processing, processing of enlargement and contraction is carried out. To perform processing of I-P conversion and that of enlargement and contraction, a RAM (IC8004) is used.

IC8004 is a control IC for IC8003. The method of image display for I-P conversion and profile emphasis processing is controlled by I2C bus (SDA1, SCL1) from the microcomputer IC9501.

X8000 is a clock signal source for IC8003 system operation (10 MHz). IC6550 operates when the potential of the system reset terminal XRST is at the [H] level. IC8001, IC8002, and IC8006 function as the power source to drive IC8003. They generate outputs of 1.4V, 1.9V, and 2.5V, respectively.

(12) Definition conversion processing block (IC8502)

Using the SDRAM (consisting of IC8503 and IC8504), IC8502 performs the conversion of the XGA signal to a level equivalent to VGA, the modification of the screen size for normal, full, etc., zoom operation, and the movement of the screen position. This IC8502 also performs color temperature regulation according to the user menu.

For memory control, a clock signal of 100MHz is produced at X8501. This signal is supplied to IC8502 and each SDRAM.

The clock signals and the horizontal and vertical sync signals to be entered in IC8502 are classified into two categories. One is the signal (input side) synchronized with the input signal and the other is the signal (output side) synchronized with the signal to be supplied to the plasma display module. Like the video signals, the clock and sync signals are fed from IC7501 and IC9000, respectively.

(13) ON-screen signal generator block

IC9401 is generating ON-screen signals. The contents of display are controlled by the SBD, SBK, and CSOSD signals sent from the microcomputer IC9501. The SBD, SBK, and CSOSD signals are put into the conversion of 5V → 3V through IC9405 and the input is entered in IC9401. The clock, horizontal sync, and vertical sync signals are sent from the IC9000 block.

(14) Gate array block (Post G/A IC9000)

For video signal processing, IC9000 is provided mainly with the four functions specified below. These functions are controlled by bus SIK2, SID2, and CSYUMA from the microcomputer IC9501 and by the signals of signal reset and video mute.

- ① The video signal output from IC8003 is sent to IC8502. The video signal from IC8502 is output to IC8003. This output is ON/OFF controlled by the microcomputer.
- ② The video signal from IC8003/IC8502 is selected. In the case of dual screen processing, synthesis processing is carried out and the output is sent to IC9403 and IC9404.
- ③ γ processing is conducted for video signals. The γ curve is set up by the microcomputer.
- ④ IC9401 (ON-screen IC) is controlled. The synthesis of ON-screen signals into video signals is carried out.

(15) Plasma display module output block

In IC9003 and IC9004, the 48-bit parallel video signal output from IC9000 is processed for conversion into the LVDS serial signal. The resultant output is sent to the plasma display module ("AD" connector).

2. Sync signal processor block

(1) AD converter block (IC6501, IC6701)

In the AD converter of IC6501 and IC6701, a sampling clock signal (clock on input side) is generated on the basis of the horizontal sync input (Pin 111) from the YU connector and the PC connector (Pin 10). Based on this clock signal at Pin 98 (Pin 99 for IC6701), a clock signal output at half the frequency is generated from Pin 101. The phase comparison output (pulses synchronized with the input horizontal sync signal) is generated from Pin 103 and fed to the latter stages. The oscillation frequency for clock signals differs according to the input signal. Phase comparison is effected when the potential at Pin 106 is at the "L" level. This phase comparison pin is controlled by the phase comparison stop signal output from IC7501.

(2) Panel link block (IC7002)

During the entry of RGB3 input, the signals of clock, horizontal and vertical sync, and video period discrimination are output.

All these signals are entered in IC7501. Under the control from IC7501, clock signals are fed to other ICs.

(3) Gate array block (Pre G/A IC7501)

IC7501 is used as a timing controller intended to generate a variety of timing pulses based on the clock and horizontal sync signals from IC6701 (AD converter) and the vertical sync signal input entered from the YU connector and the PC connector (Pin 12).

The clock signals and various pulses are fed to IC6501, IC6701, IC8003, and IC8502. According to the signal type and the input mode, the output is generated through pulse changeover for IC8003 and IC8502 in conformity to the video signal output. (Refer to 1. Video signal processor block.)

IC7501 operates with the system clock signal (CLKS_PRE signal) sent from IC9000.

(4) Module side (output side) clock generator block

The clock signal on output side is generated at X9000 (76MHz). This clock signal is supplied to each IC and the plasma display module.

(5) Gate array block (Post G/A IC9000)

IC9000 is used as a timing controller intended to generate a variety of timing pulses based on the clock and horizontal sync signals from IC7501 (Pre G/A) and the clock signal from X9000.

The clock signals and various pulses are fed to IC8003, IC8502, IC9401, IC9403, and IC9404 on input side. According to the signal type and the input mode, the output is generated through pulse changeover for IC8003 and IC8502 in conformity to the video signal output. (Refer to 1. Video signal processor block.)

3. System control block

IC9501 is used as a microcomputer (μ -COM) for system control. In this IC9501, various controls are carried out, such as input signal changeover, setting in the A/D converter block, adjustment of the timing and video chroma block for the output signals from the timing controller, selection of the hue and color depth level for the HD decoder and the method of digital signal processing, various controls of the plasma display module, diagnostic judgment for troubleshooting inside the set, and so on.

Pin 34 of the microcomputer IC9501 is used as a reset terminal. It is connected to the reset IC (IC9505). This terminal generally works at 5V.

The contents of control are described below. For the matters not described here, please refer to the relevant explanations given to each individual circuit block.

(1) Input signal discrimination

The microcomputer performs the discrimination of input signal type based on the horizontal sync and vertical sync signals (Pin 7 and Pin 9 of the YU connector and the PC connector) and the information (at Pins 1, 2, 4, and 5 of the BU connector) sent from the VIDEO PWB through the I2C bus. Based on the result of the above-mentioned discrimination, the microcomputer performs the control of various blocks. During the entry of VIDEO3 input (for an input at Terminal S), the detection of S2 (automatic discrimination of the Terminal S system) is carried out.

With the voltage at Pin 3, the screen size (screen mode) is automatically modified.

Voltage at Pin 3	Other than the right	1.4~2.4V	3.5~5.0
Result of discrimination	4:3 (general)	4:3 (letter box)	16:9 (squeeze)
Screen size	By user's selection	Zoom	Full

During the entry of RGB3 input, the presence (if any) of the input signal is identified according to the status of the SCDT terminal (Pin 100, at "H" in ordinary operation) and operation for power management is conducted.

(2) Auto-picture function

In IC7501, the screen position data are computed according to the input video signal when the auto-picture feature is turned ON for the RGB input. During the entry of RGB3 input, the screen position data are computed based on the DE signal sent from IC7002. The microcomputer picks up the screen position data from IC7501, and sets up the screen position in IC7501 and IC8502 based on the obtained data.

(3) Last memory function

The input mode, power ON/OFF status, setting values of various user controls, factory servicing values, and such data are stored in an external EEPROM (IC9504). During the entry of VIDEO input, however, data of color, tint, and UCOL are stored in IC1011 of the VIDEO PWB. In the SECAM mode, data of R-Y, B-Y, and BELL are also stored in this IC1011.

(4) Error detector block

The microcomputer is in charge of fan stoppage, plasma display module alarming, and temperature sensor detection.

① Detection of fan stop

Two fans are loaded on the set main body. If a stop signal ([H]) from either fan is entered in IC9805 and even a single fan unit stops as a result, the "L" signal is sent to the microcomputer IC9501. When either fan stops, the relevant LED blinks in green and the power supply assumes a standby condition. The function of fan stop detection is disabled when Pin 2 and Pin 3 of S9802 are short-circuited with a jumper wire or the like.

② Panel crack detection

If there is any abnormality in the plasma display module (signal system), an alarm signal is sent from Pin 37 of the "AD" connector to Pin 100 of the microcomputer. When this terminal is at the "L" level, the LEDs repeat reciprocal lighting in red and green, in order to indicate a condition of power supply in standby mode. To reset alarming, the input changeover key is kept pressed at the set main body and the mains POWER of the main body is turned "ON." In this case, it is necessary to keep pressing the input changeover key at the main unit for more than 2 seconds.

③ Temperature error detection

When the temperature sensor of the power unit senses any abnormality or when Pin 8 of the "PN" connector is turned to be at the "L" level, the LED flashes in red and a condition of power standby is assumed.

(5) Temperature sensor block

The information about the internal temperature in the set is transmitted from the temperature sensor boards (SEND PWB, SENT PWB, SENU PWB) to the microcomputer via the I2C bus SCL5 and SDA5 of the T1, T3 connector. Based on this information, the microcomputer controls the output voltage of the regulator IC9802 and IC9803 via IC9805. In this fashion, fan revolutions are increased and decreased.

(6) Remote control block

This system is applicable to remote controls. An infrared remote control light receiver block RV2101 is mounted on the LED PWB. Its signal input is entered in IC9808 through the "LD" connector. The 232C PWB is provided with the wired remote control input terminals and an input from the "RA" connector is entered in IC9808. In IC9808, a signal of infrared remote control is generally selected and its input is fed to Pin 7 of the microcomputer IC9501. When a wired remote control is connected, the potential at Pin 2 of IC9808 is turned at the "L" level and the signal of wired remote control is selected so that its input is entered in the microcomputer.

(7) Control lock block

When S2001 is turned on (pressed condition) inside the 232C PWB, Pin 19 of the microcomputer IC9501 is turned "H" and all keys other than the POWER key of the set main body are disabled.

(8) PDP module control block

With the PDP module, information about the screen position and input signals is controlled by the microcomputer through the bus SDATA, SCK, and LE. Power save control for the PDP module is effected through Pins 32, 33, 34, 35, and 36 of the AD connector. Pin 34 is used for the average brightness data input from the PDP module.

(9) Voice control block

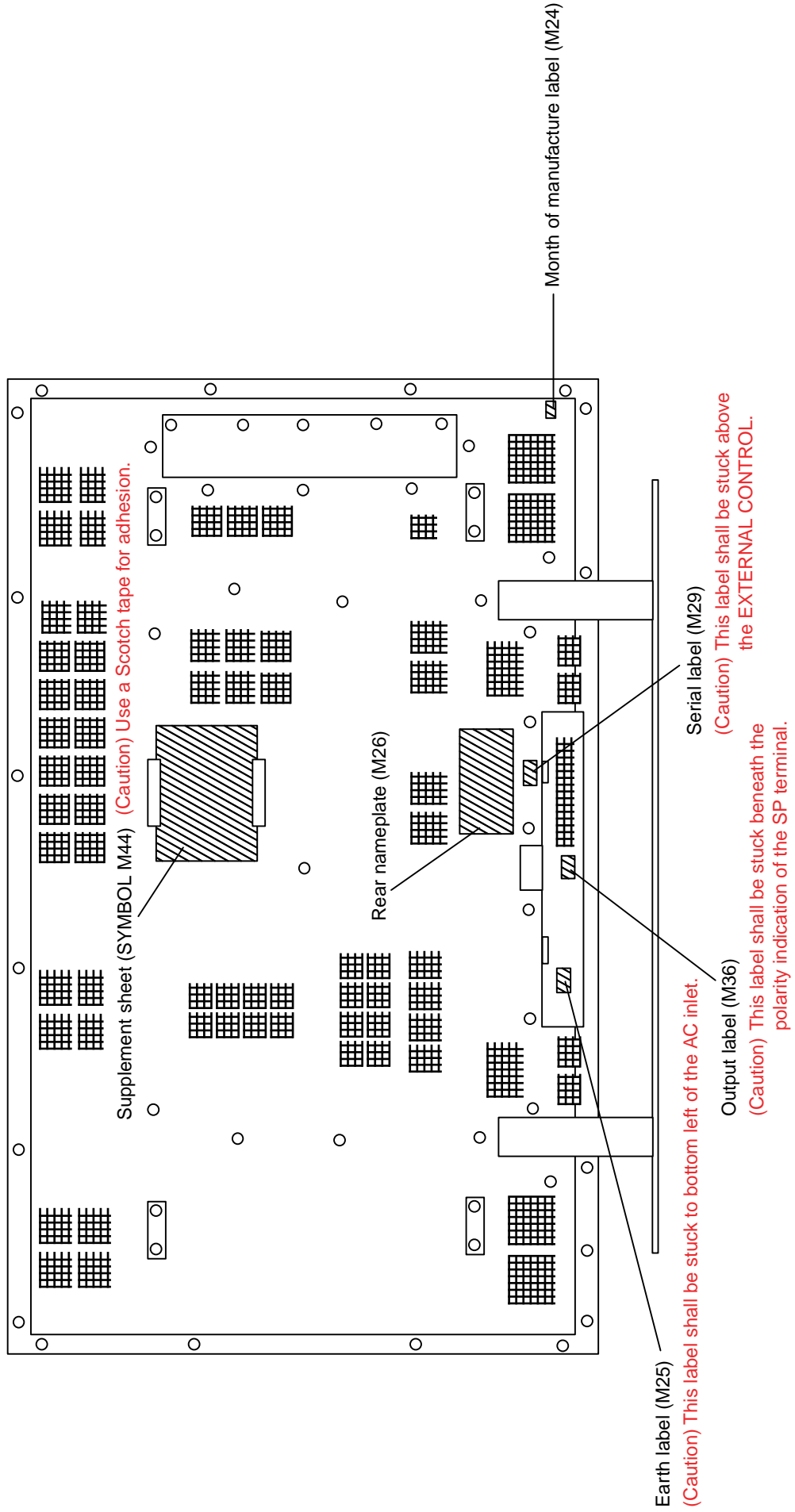
The AUDIO unit controls the sound volume, balance, and the sound quality through IC9505 with the aid of the bus SDA2AE and SCL2AE. Transmission of the voice output is suspended when Pin 3 of the AE connector (SMUTE terminal) is at the "H" level or when Pin 4 of the AE connector (POMUTE terminal) is at the "L" level.

METHOD OF DISASSEMBLY

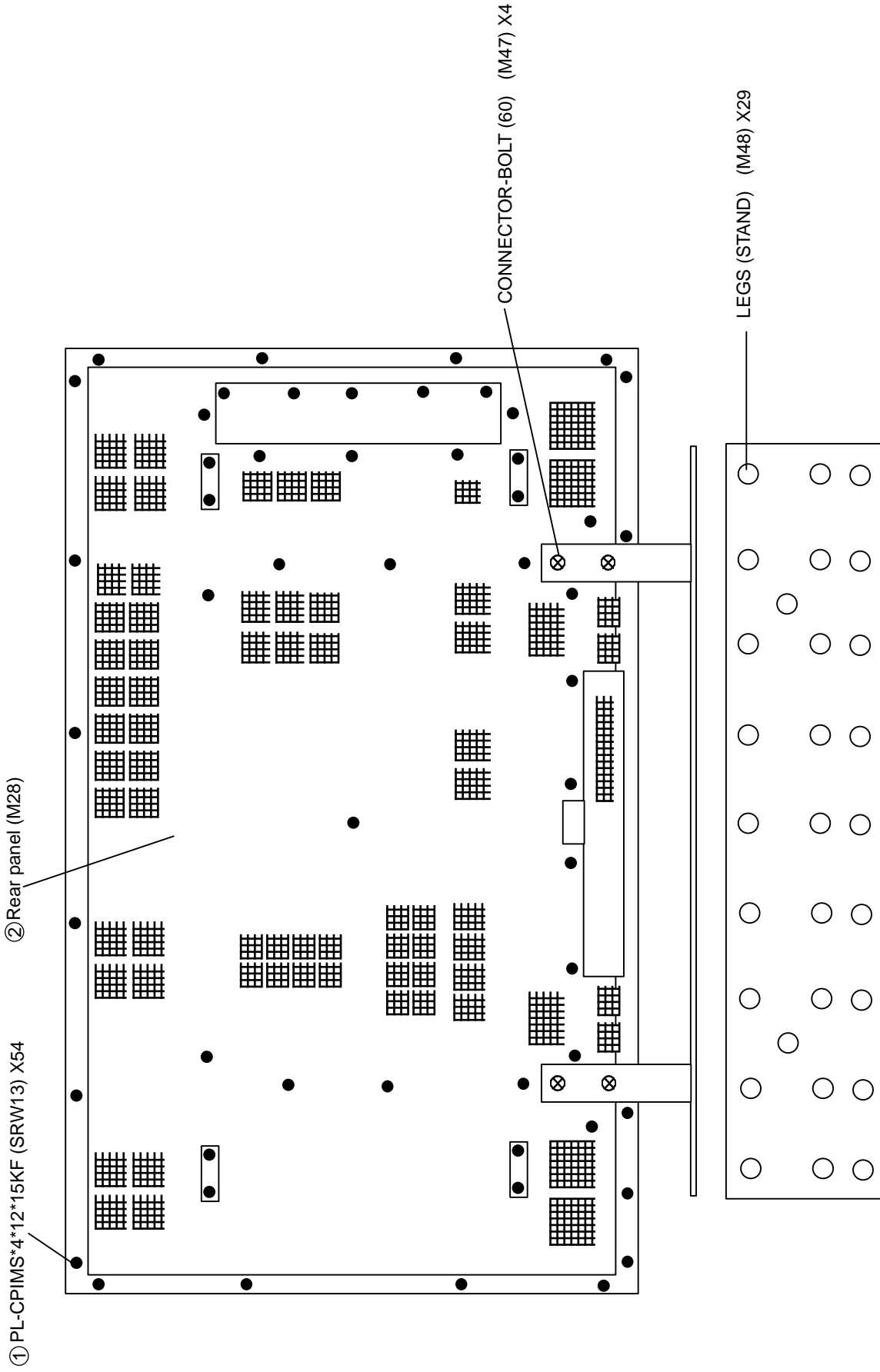
(Cautions)

1. Before disassembly, turn power off the main unit and pull out the power plug from the wall outlet.
2. Use a screwdriver with a fitting size. Otherwise, the screw threads may be damaged.
3. Reassembly can be carried out in the reverse order for disassembly. Refer to the disassembly procedures and forward reassembly in the reverse order.
4. The order for taking out the parts (or components) is indicated by the foregoing numeral that is attached to the name of each part (or component).
5. The wire connector symbol is indicated by two digits of Marking . Read CN- when examining the table of parts.

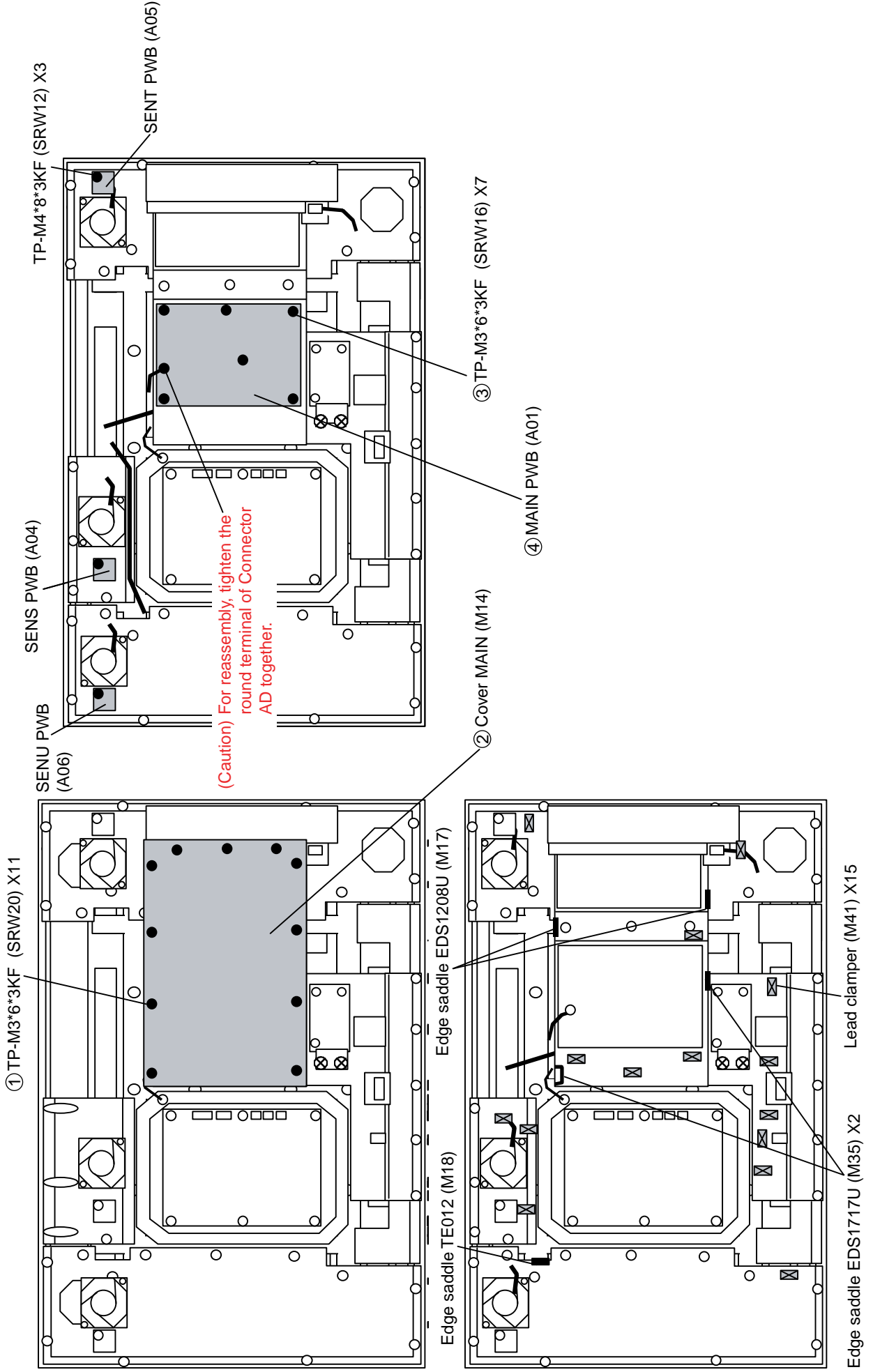
Month of manufacture label



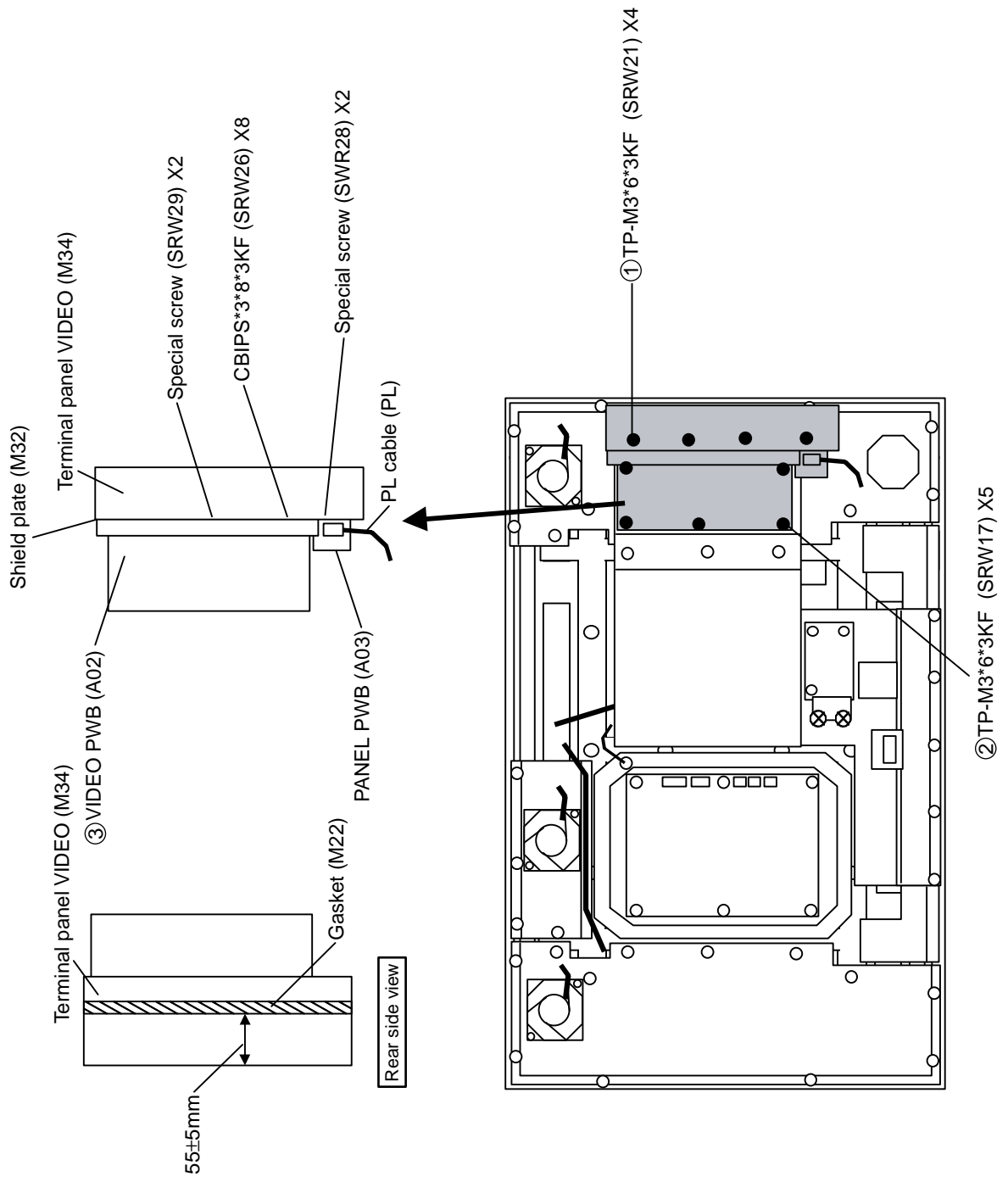
Removal of the back cover



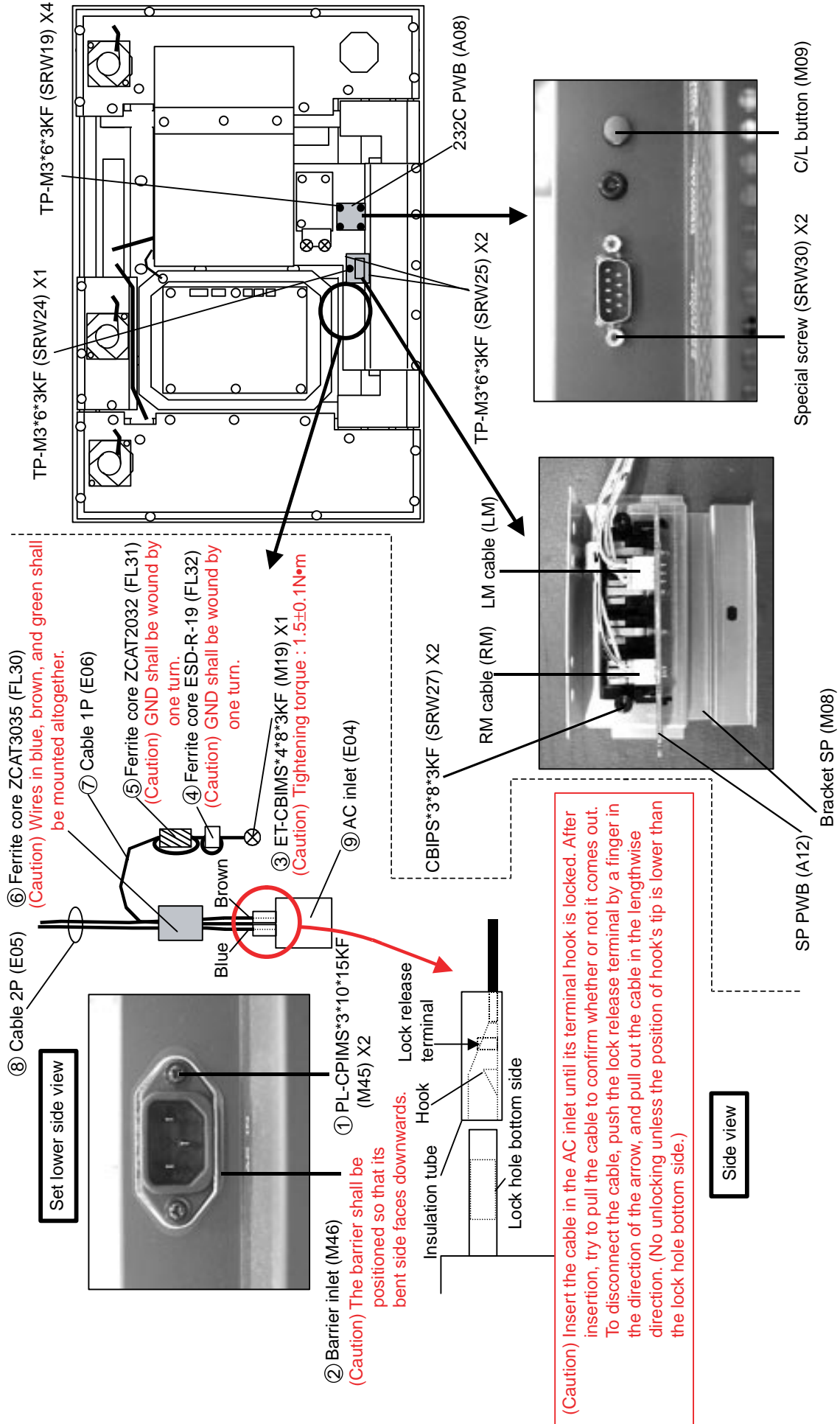
Removal of the MAIN PWB



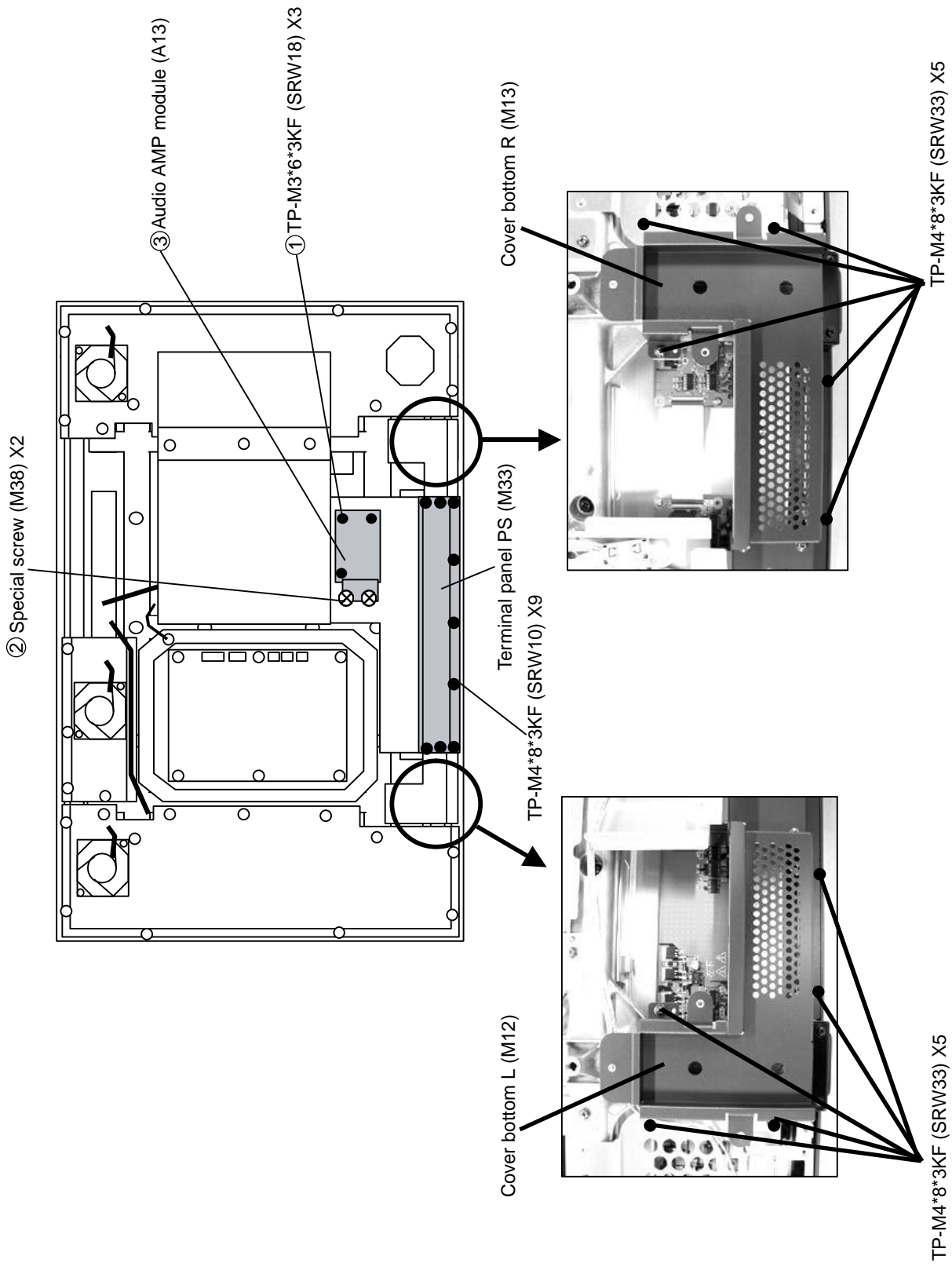
Removal of the VIDEO PWB



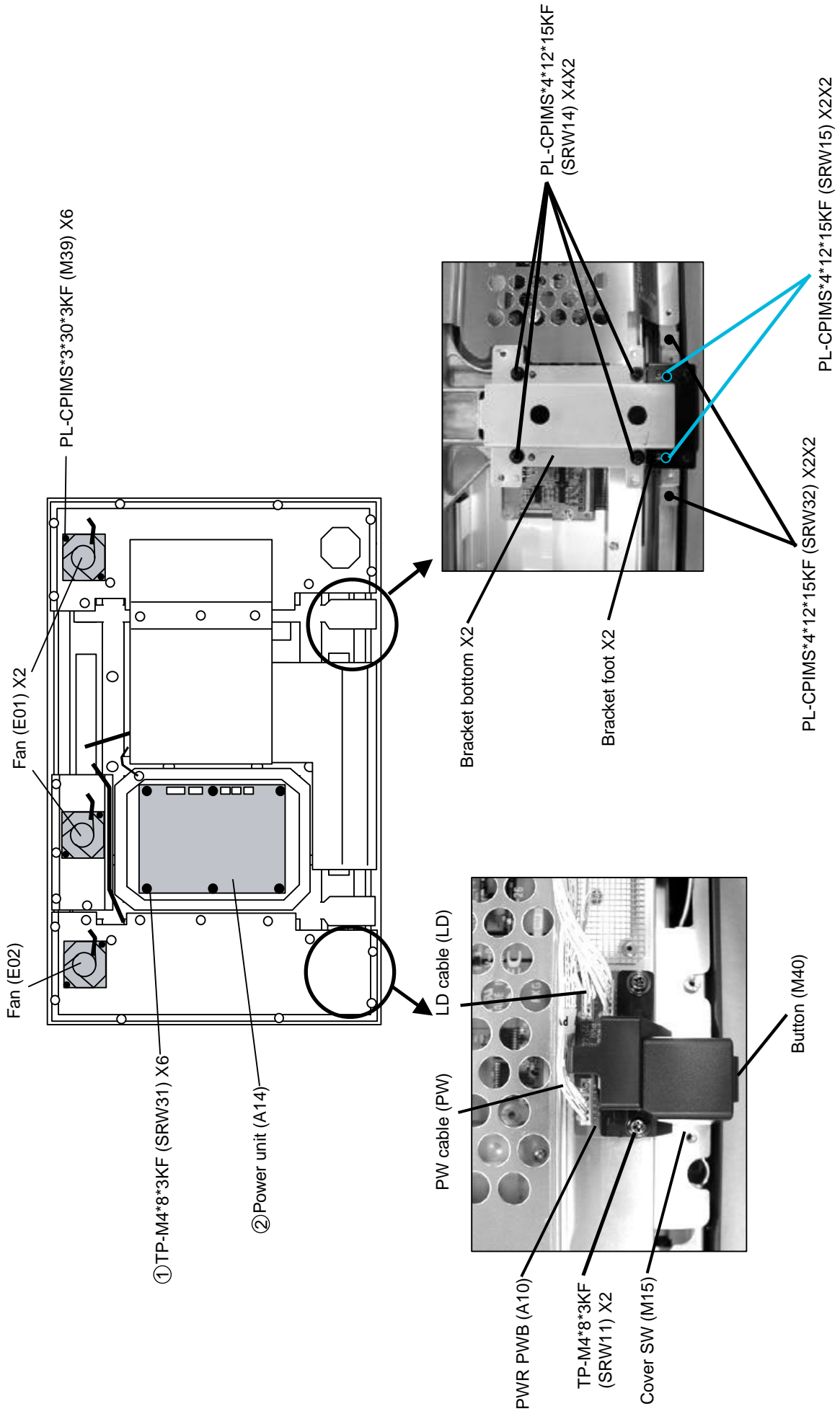
Removal of the AC inlet



Removal of the audio AMP module

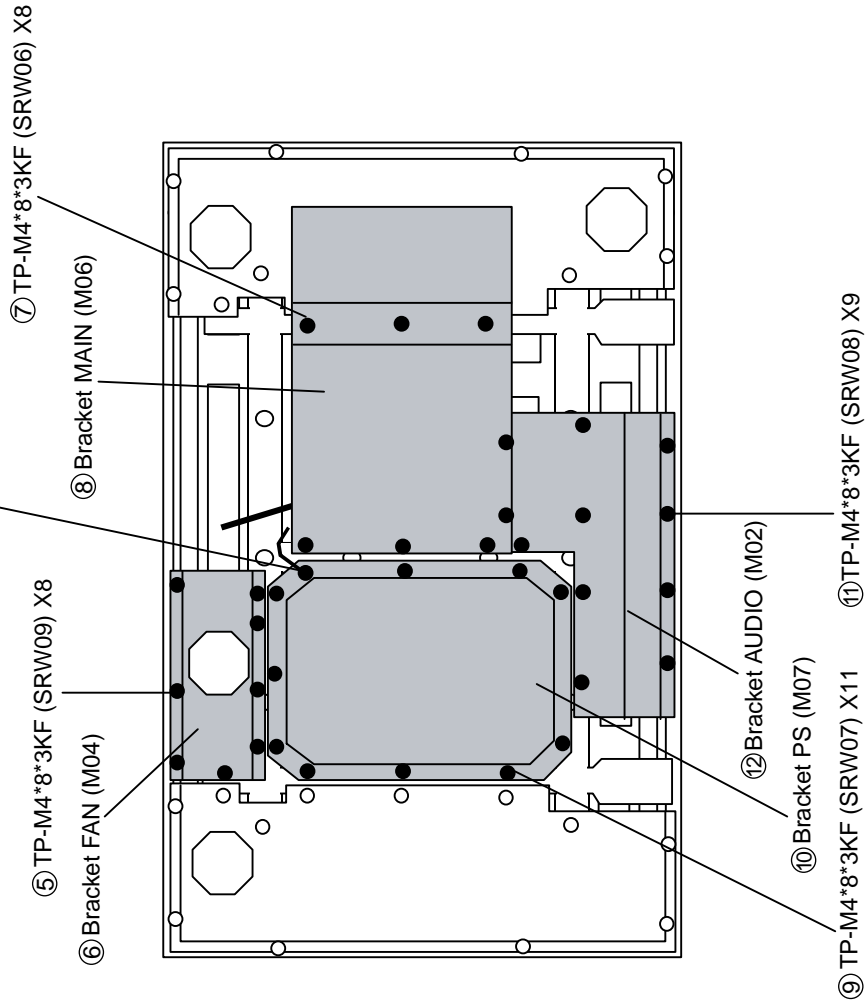


Removal of the power unit

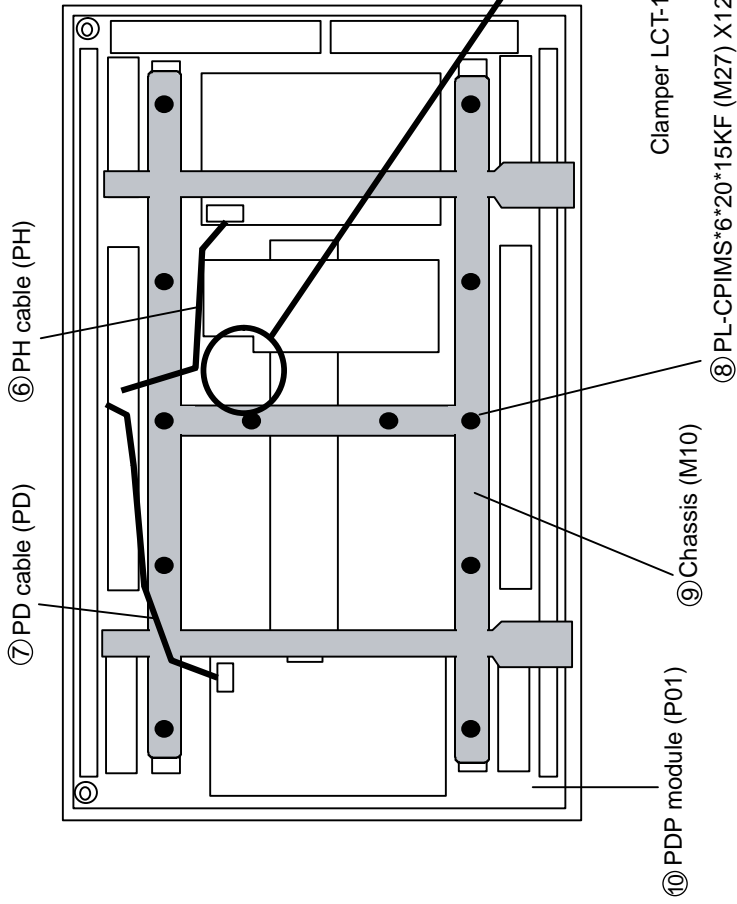


Removal of the various brackets

(Caution) For reassembly, tighten the round terminal (E03) together.

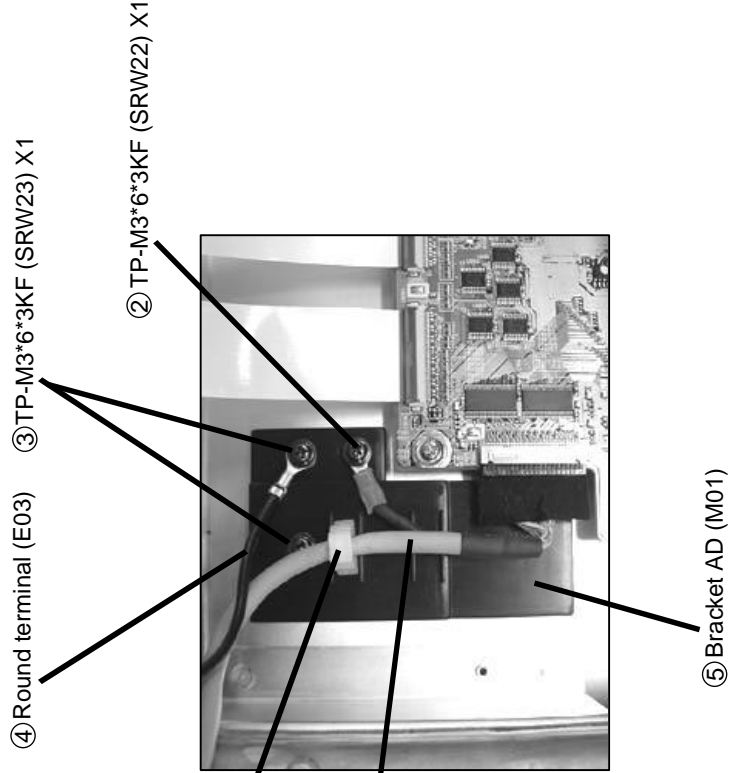


Removal of the PDP module

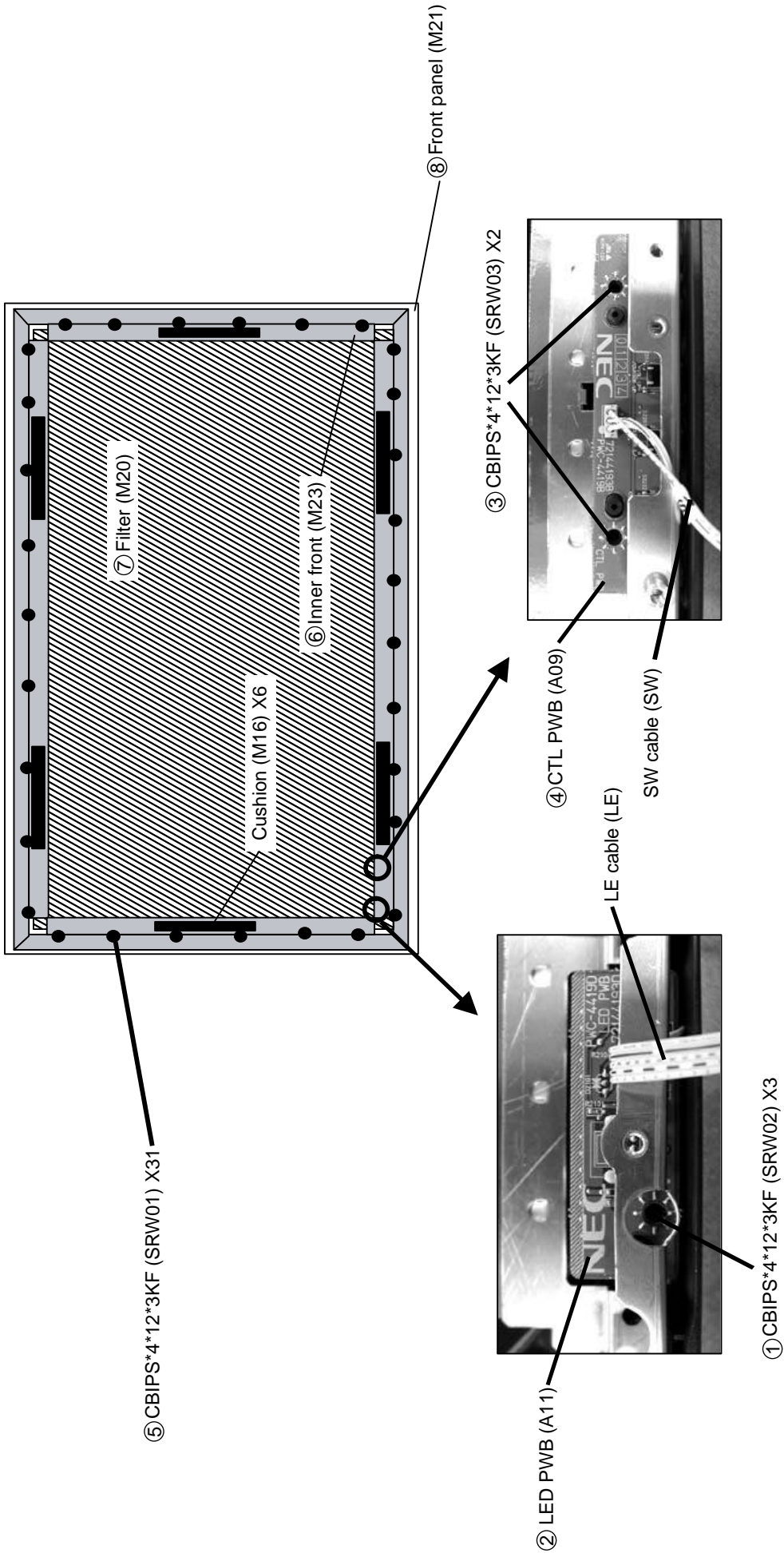


① AD cable (AD)

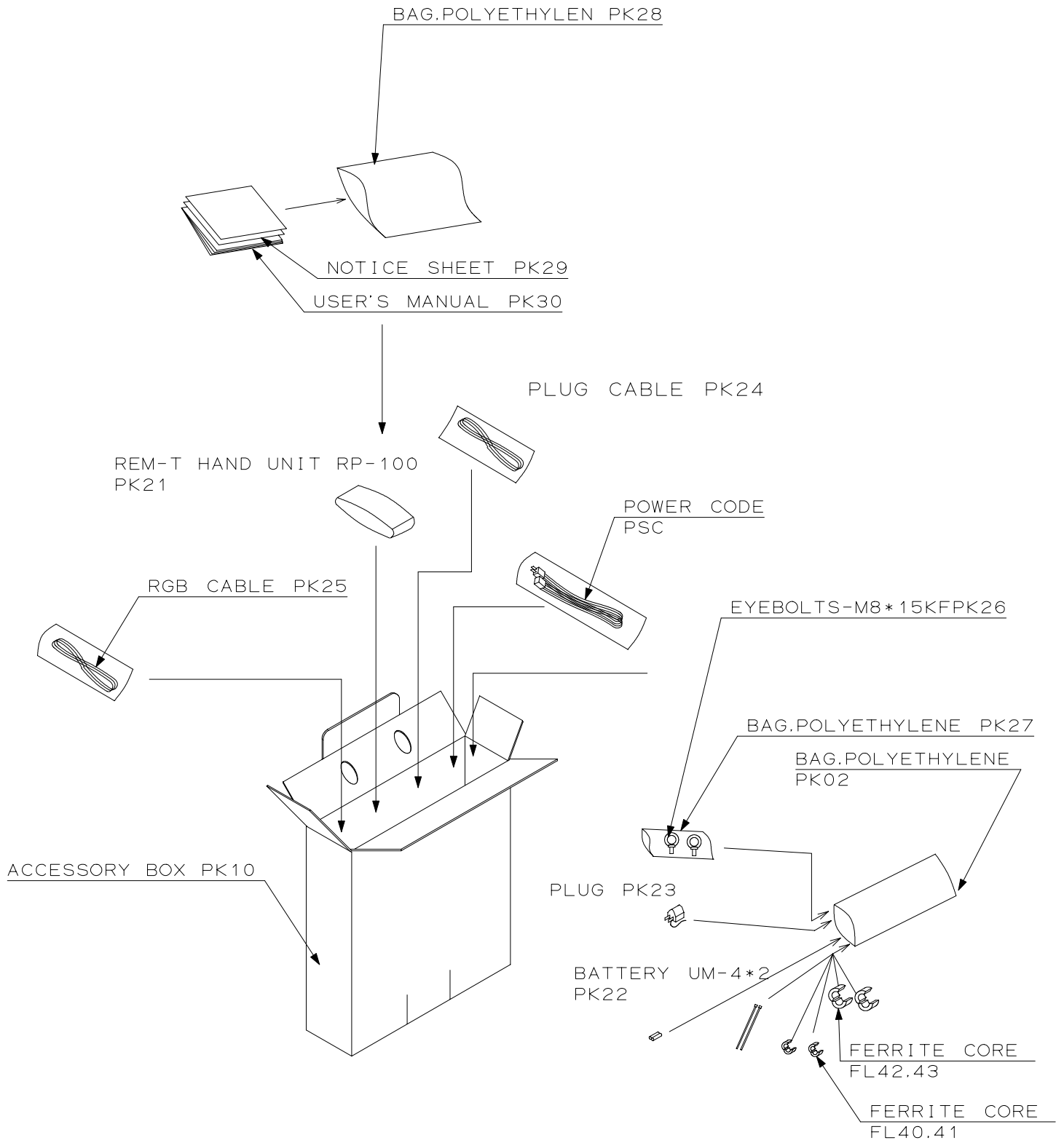
(Caution) For reassembly, insert the side, bearing no AD label.

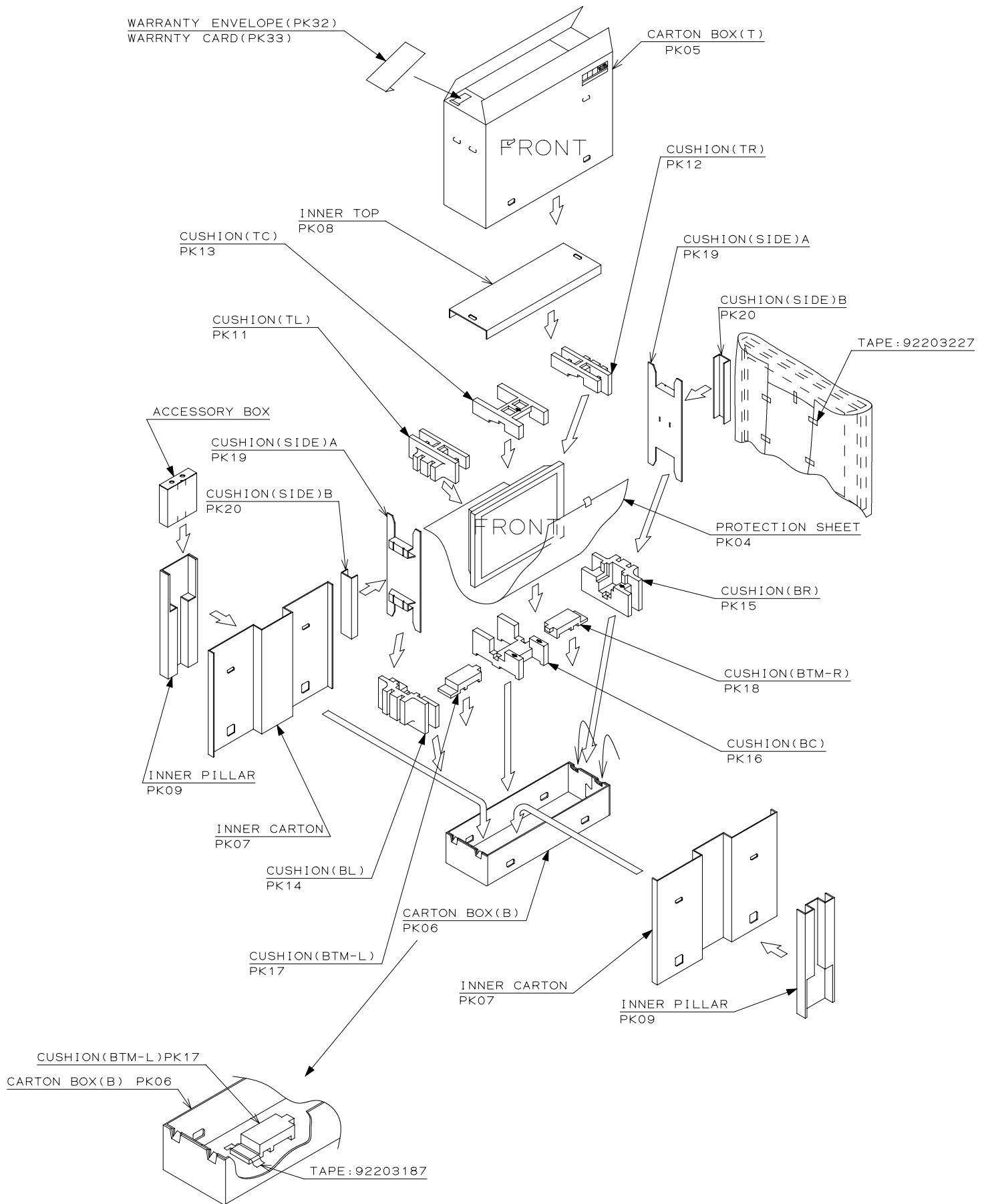


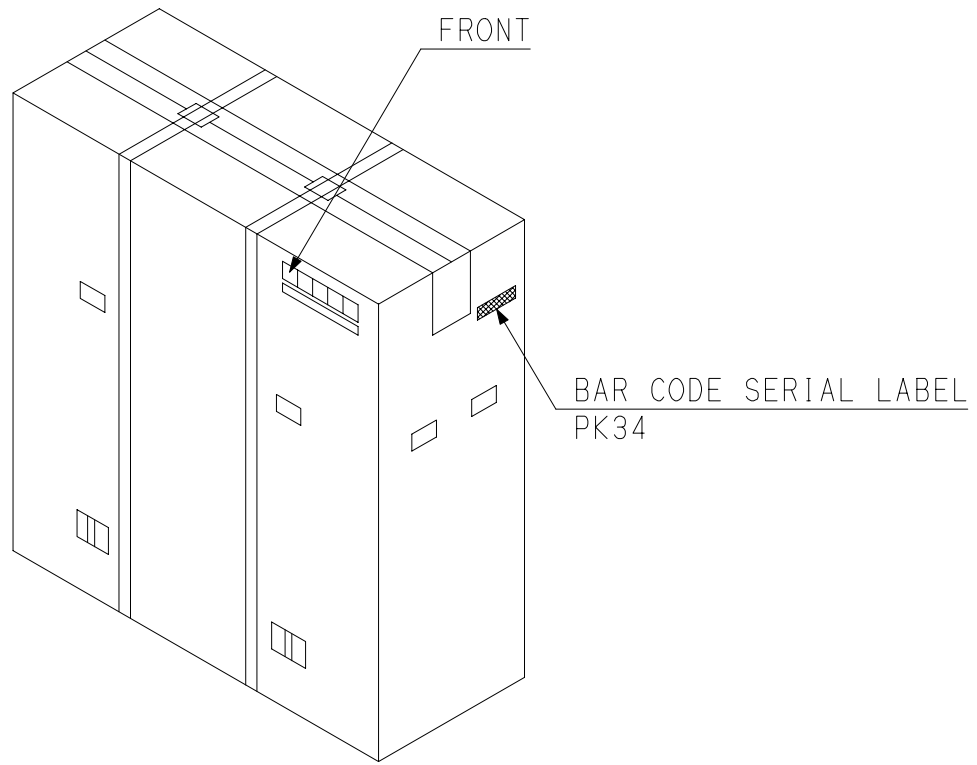
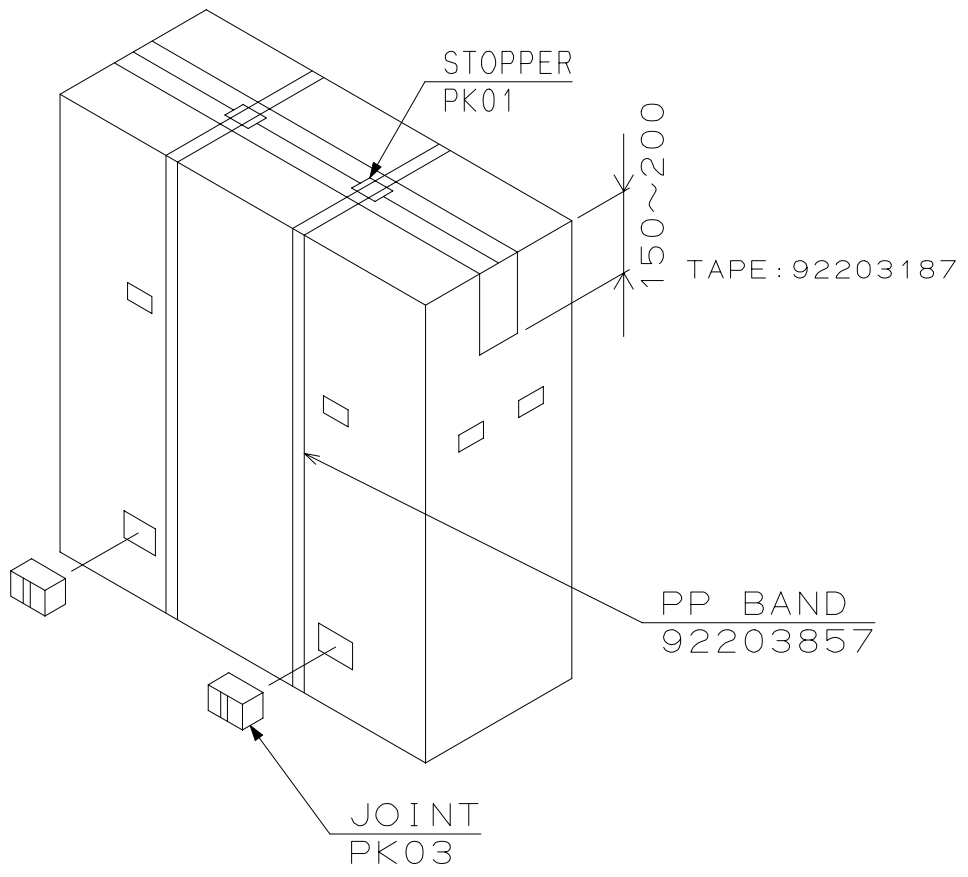
Removal of the front panel



PACKAGING







PART LIST

Notes:

1. Parts orders must contain model name, parts number and parts name.
2. When you place an order for spare parts, please refer to the respective service manual and mention the right parts number on your P.O. sheets
3. The letters NSP in the table indicate non-service parts.
4. Please refer to METHOD OF DISASSEMBLY or PACKAGING of servicemanual about a parts layout.

PX-61XM1A [01272060]				VER. 19	
SYMBOL	PARTS NAME	PARTS NO.	Q'TY	NOTE	
*** PDP MODULE ***					
P01	PDP-NP61C1MF01	09S900015	1		
*** PWB ASSYS ***					
A01	MAIN PWB ASSY	0936D6M01	1	UNUSED	
A02	VIDEO PWB ASSY	0936D6VA1	1		
A03	PANEL PWB ASSY	0936D6VB1	1		
A04	SENS PWB ASSY	0936D6VC1	1		
A05	SENT PWB ASSY	0936D6VD1	1		
A06	SENU PWB ASSY	0936D6VE1	1		
A07					
A08	232C PWB ASSY	0935V8SA3	1		
A09	CTL PWB ASSY	0935V8SB3	1		
A10	PWR PWB ASSY	0935V8SC3	1		
A11	LED PWB ASSY	0935V8SD3	1		
A12	SP PWB ASSY	0935V8SE3	1		
A13	AUDIO AMPLIFIER MODULE	03S130101	1		
A14	POWER UNIT	03S110021	1		
*** MISCELLANEOUS ELECTRICAL PARTS ***					
CN-AB	CN 4P(AB) 525W,2468-26	07SW4W003	1		
CN-AD	CABLE 41P L450	07S530012	1		
CN-AE	CN 5P(AE) 300W,2468-26	07SB5W005	1		
CN-BU	CN 10P(BU) 125W,2468-26	07SB0W002	1		
CN-DS	CN 4P(DS) 50S,1007-26	073B4V002	1		
CN-LD	CN 5P(LD) 1275W,2468-26	07SB5W006	1		
CN-LE	CN 5P(LE) 200,2468-26	073B508LE	1		
CN-LM	CN 3P(LM) 325,2468-26	073B313LM	1		
CN-PA	CN 6P(PA) 600,2468-26	073B624PA	1		
CN-PC	CN 13P(PC) 150W,MIX	07SBCW001	1		
CN-PD	CN 10P(PD) 825W,1007-20	07SW0W003	1		
CN-PH	CN 9P(PH) 550W,1007-20	07SW9W003	1		
CN-PL	CABLE, TWINAX 21P L450	07S530002	1		
CN-PM	CN 12P(PM) 250W,2468-26	07SBBW004	1		
CN-PN	CN 8P(PN) 250W,2468-26	07SB8W002	1		
CN-PQ	CN 5P(PQ) 675,2468-26	073B527PQ	1		
CN-PV	CN 4P(PV) 725,2468-26	073B429PV	1		
CN-PW	CN 6P(PW) 1275W,2468-26	07SB6W003	1		
CN-RM	CN 2P(RM) 350,2468-26	073B214RM	1		
CN-RS	CN 9P(RS) 350W,2468-26	07SB9W002	1		
CN-SW	CN 3P(SW) 1100W,2468-26	07SB3W002	1		
CN-SY	CN 5P(SY) 175W,1691-28	07SB5W001	1		
CN-T1	CN 4P(T1) 400W,2468-26	07SB4W002	1		
CN-T3	CN 4P(T3) 750W,2468-26	07SB4W003	1		
CN-T4	CN 4P(T4) 525,2468-26	073B421T4	1		
CN-YU	CN 12P(YU) 125W,MIX	07SBBW003	1		
FL11	FERRITE CORE ZCAT2032-93	061605059	1		
FL12	FERRITE CORE ZCAT2032-93	061605059	1		
FL20	FERRITE CORE	061605095	1		
FL21	FERRITE CORE	061605095	1		
FL22	FERRITE CORE	061605095	1		
FL30	FERRITE CORE	061605095	1		AC INLET SASSY

SYMBOL	PARTS NAME	PARTS NO.	Q'TY	NOTE
FL31	FERRITE CORE ZCAT2032-93	061605059	1	AC INLET SASSY
FL32	FERRITE CORE(ESD-R-19)	061605166	1	AC INLET SASSY
FL33	FERRITE CORE ZCAT2032-93	061605059	1	
FL35	FERRITE CORE ZCAT2032-93	061605059	1	
FL36	FERRITE CORE ZCAT2032-93	061605059	1	
FL37	FERRITE CORE ZCAT2032-93	061605059	1	
FL38	FERRITE CORE ZCAT2032-93	061605059	1	
FL5	FERRITE CORE ZCAT2032-93	061605059	1	
FL6	FERRITE CORE ZCAT2032-93	061605059	1	
FL7	FERRITE CORE ZCAT2032-93	061605059	1	
E01	FAN MOTOR 109P1212L4D03	03S170001	2	
E02	FAN MOTOR 109P1212L4D04	03S170002	1	
E03	CONNECTOR	073300126	1	
E04	AC INLET 10GEEG3C	06S760006	1	AC INLET SASSY
E05	CABLE 2P L240	07S530014	1	AC INLET SASSY
E06	CABLE 1P L360	07S530015	1	AC INLET SASSY
*** MECHANISM PARTS ***				
SRW01	CBIPS*4*12*3KF	024N03711	31	
SRW02	CBIPS*4*12*3KF	024N03711	1	
SRW03	CBIPS*4*12*3KF	024N03711	2	
SRW04	TP-M4*8*3KF	024N04591	12	
SRW05	TP-M4*8*3KF	024N04591	12	
SRW06	TP-M4*8*3KF	024N04591	8	
SRW07	TP-M4*8*3KF	024N04591	11	
SRW08	TP-M4*8*3KF	024N04591	9	
SRW09	TP-M4*8*3KF	024N04591	8	
SRW10	TP-M4*8*3KF	024N04591	9	
SRW11	TP-M4*8*3KF	024N04591	2	
SRW12	TP-M4*8*3KF	024N04591	3	
SRW13	PL-CPIMS*4*12*15KF	0910E4033	54	
SRW14	PL-CPIMS*4*12*15KF	0910E4033	8	
SRW15	PL-CPIMS*4*12*15KF	0910E4033	4	
SRW16	TP-M3*6*3KF	024N04581	7	
SRW17	TP-M3*6*3KF	024N04581	5	
SRW18	TP-M3*6*3KF	024N04581	3	
SRW19	TP-M3*6*3KF	024N04581	4	
SRW20	TP-M3*6*3KF	024N04581	11	
SRW21	TP-M3*6*3KF	024N04581	4	
SRW22	TP-M3*6*3KF	024N04581	1	
SRW23	TP-M3*6*3KF	024N04581	2	
SRW24	TP-M3*6*3KF	024N04581	1	
SRW25	TP-M3*6*3KF	024N04581	2	
SRW26	CBIPS*3*8*3KF	024N03691	8	
SRW27	CBIPS*3*8*3KF	024N03691	2	
SRW28	SCREW(D-SUB)	024N03112	2	
SRW29	SCREW(D-SUB)	024N03112	2	
SRW30	SCREW(D-SUB)	024N03112	2	
SRW31	TP-M4*8*3KF	024N04591	6	
SRW32	PL-CPIMS*4*12*15KF	0910E4033	4	
SRW33	TP-M4*8*3KF	024N04591	10	
M01	BRACKET(AD)	029F00171	1	

SYMBOL	PARTS NAME	PARTS NO.	Q'TY	NOTE
M02	BRACKET(AUDIO)ASSY	029HS0251	1	
M03	BRACKET(BOTTOM)	029H00431	2	
M04	BRACKET(FAN)PS	029H00481	1	
M05	BRACKET(FOOT)	029P00351	2	
M06	BRACKET(MAIN)ASSY	029HS0261	1	
M07	BRACKET(PS)ASSY	029HS0241	1	
M08	BRACKET(SP)	029P00301	1	
M09	C/L BUTTON	024G05221	1	
M10	CHASSIS	029H00341	1	
M11	CLAMP(LCT-1S)	029C00551	1	
M12	COVER(BOTTOM-L)ASSY	029PS0421	1	
M13	COVER(BOTTOM-R)ASSY	029PS0431	1	
M14	COVER(MAIN)	029H00451	1	
M15	COVER(SW)	029FS0031	1	
M16	CUSHION(FILTER)	029J00171	6	
M17	EDGING SADDLE(EDS-1208U)	029C00461	2	
M18	EDGING(TE-012)	029C00541	1	
M19	ET-CBIMS*4*8*3KF	024N04001	1	
M20	FILTER	029KS0051	1	
M21	FRONT PANEL ASSY	029DS0101	1	
M22	GASKET(L430*6*T6)	029C00681	1	
M23	INNER FRONT	029H00351	1	
M24				UNUSED
M25				UNUSED
M26	NAME PLATE(60XM1A)	029L00541	1	NSP
M27	PL-CPIMS*6*20*15KF	029N00101	12	
M28	REAR PANEL ASSY	029PS0291	1	
M29	SERIAL LABEL	024L44731	1	
M30	SHIELD PLATE(L)ASSY	029HS0271	1	
M31	SHIELD PLATE(R)ASSY	029HS0281	1	
M32	SHIELD PLATE(VIDEO)	029H00621	1	
M33	TERMINAL PANEL(PS)	029P00341	1	
M34	TERMINAL PANEL(VIDEO)	029P00331	1	
M35	EDGE SADDLE	024C04371	2	
M36				UNUSED
M37	BAND (L=100)	024280701	1	
M38	SCREW,P-CPIMS*3*14*3KF	024850121	2	
M39	PL-CPIMS*3*30*3KF	0910E3196	6	
M40	BUTTON(PWR)	024G05211	1	
M41	CLAMPER,WIRE	012281301	15	
M42	LEAD CLAMPER(D5.2)	024C00091	3	
M43	CLAMPER,WIRE (D8.3)	024C00101	1	
M44	SUPPLEMET SHEET (PDP)	078038501	1	
M45	PL-CPIMS*3*10*15KF	0910E3063	2	
M46	BARRIER(INLET)	024J15941	1	AC INLET SASSY
M47	CONNECTOR-BOLT(60)	024N04431	4	
M48	LEGS(STAND)	024J12331	29	
*** PRINTED & PACKING MATERIALS ***				
FL40	FERRITE CORE ZCAT2032-930	061605059	1	
FL41	FERRITE CORE ZCAT2032-930	061605059	1	
FL42	CORE,FERRITE SFT-72SB	06S170002	1	

SYMBOL	PARTS NAME	PARTS NO.	Q'TY	NOTE
FL43	CORE,FERRITE SFT-72SB	06S170002	1	
PSC	POWER CORD U3 L3.0M L	07S552001	1	
PK01	STOPPER	024282431	2	
PK02	BAG,POLYETHYLENE(150*370)	024813191	2	
PK03	JOINT	024CS0551	4	
PK04	PROTECTION SHEET	029M00231	1	
PK05	CARTON BOX(T)A	029MS0481	1	
PK06	CARTON BOX(B)	029MS0441	1	
PK07I	NNER CARTON	029MS0451	2	
PK08	INNER TOP	029MS0461	1	
PK09	INNER PILLAR	029MS0471	2	
PK10	ACCESSORY BOX(61XM1A)	029MS0511	1	
PK11	CUSHION(TL)	029MS0531	1	
PK12	CUSHION(TR)	029MS0541	1	
PK13	CUSHION(TC)	029MS0551	1	
PK14	CUSHION(BL)	029MS0561	1	
PK15	CUSHION(BR)	029MS0571	1	
PK16	CUSHION(BC)	029MS0581	1	
PK17	CUSHION(BTM-L)	029MS0591	1	
PK18	CUSHION(BTM-R)	029MS0601	1	
PK19	CUSHION(SIDE)A	029MS1351	2	
PK20	CUSHION(SIDE)B	029MS1361	2	
PK21	REM-T HAND UNIT RP-100	03S120002	1	
PK22	BATTERY,DRY CELL UM-4*2	068001007	2	
PK23				UNUSED
PK24	CABLE,REMOTE CONTROLLER	073499404	1	
PK25	CABLE,D-SUB 15P L1800	07S580001	1	
PK26	EYEBOLTS-M8*15KF	029N00111	2	
PK27	WARRANTY ENVELOPE(100*220)	078047921	1	
PK28	BAG,POLYETHYLENE(270*370)	024806961	1	
PK29	NOTICE SHEET A(PDP)	078038621	1	
PK30	USER'S MANUAL PX-61XMA	07S800261	1	
PK31				UNUSED
PK32				UNUSED
PK33				UNUSED
PK34	BAR CODE SERIAL LABEL	016761791	1	

PX-61XM1G [01272061]				VER. 19	
SYMBOL	PARTS NAME	PARTS NO.	Q'TY	NOTE	
*** PDP MODULE ***					
P01	PDP-NP61C1MF01	09S900015	1		
*** PWB ASSYS ***					
A01	MAIN PWB ASSY	0936D6M01	1	UNUSED	
A02	VIDEO PWB ASSY	0936D6VA1	1		
A03	PANEL PWB ASSY	0936D6VB1	1		
A04	SENS PWB ASSY	0936D6VC1	1		
A05	SENT PWB ASSY	0936D6VD1	1		
A06	SENU PWB ASSY	0936D6VE1	1		
A07					
A08	232C PWB ASSY	0935V8SA3	1		
A09	CTL PWB ASSY	0935V8SB3	1		
A10	PWR PWB ASSY	0935V8SC3	1		
A11	LED PWB ASSY	0935V8SD3	1		
A12	SP PWB ASSY	0935V8SE3	1		
A13	AUDIO AMPLIFIER MODULE	03S130101	1		
A14	POWER UNIT	03S110021	1		
*** MISCELLANEOUS ELECTRICAL PARTS ***					
CN-AB	CN 4P(AB) 525W,2468-26	07SW4W003	1		
CN-AD	CABLE 41P L450	07S530012	1		
CN-AE	CN 5P(AE) 300W,2468-26	07SB5W005	1		
CN-BU	CN 10P(BU) 125W,2468-26	07SB0W002	1		
CN-DS	CN 4P(DS) 50S,1007-26	073B4V002	1		
CN-LD	CN 5P(LD) 1275W,2468-26	07SB5W006	1		
CN-LE	CN 5P(LE) 200,2468-26	073B508LE	1		
CN-LM	CN 3P(LM) 325,2468-26	073B313LM	1		
CN-PA	CN 6P(PA) 600,2468-26	073B624PA	1		
CN-PC	CN 13P(PC) 150W,MIX	07SBCW001	1		
CN-PD	CN 10P(PD) 825W,1007-20	07SW0W003	1		
CN-PH	CN 9P(PH) 550W,1007-20	07SW9W003	1		
CN-PL	CABLE, TWINAX 21P L450	07S530002	1		
CN-PM	CN 12P(PM) 250W,2468-26	07SBBW004	1		
CN-PN	CN 8P(PN) 250W,2468-26	07SB8W002	1		
CN-PQ	CN 5P(PQ) 675,2468-26	073B527PQ	1		
CN-PV	CN 4P(PV) 725,2468-26	073B429PV	1		
CN-PW	CN 6P(PW) 1275W,2468-26	07SB6W003	1		
CN-RM	CN 2P(RM) 350,2468-26	073B214RM	1		
CN-RS	CN 9P(RS) 350W,2468-26	07SB9W002	1		
CN-SW	CN 3P(SW) 1100W,2468-26	07SB3W002	1		
CN-SY	CN 5P(SY) 175W,1691-28	07SB5W001	1		
CN-T1	CN 4P(T1) 400W,2468-26	07SB4W002	1		
CN-T3	CN 4P(T3) 750W,2468-26	07SB4W003	1		
CN-T4	CN 4P(T4) 525,2468-26	073B421T4	1		
CN-YU	CN 12P(YU) 125W,MIX	07SBBW003	1		
FL11	FERRITE CORE ZCAT2032-93	061605059	1		
FL12	FERRITE CORE ZCAT2032-93	061605059	1		
FL20	FERRITE CORE	061605095	1		
FL21	FERRITE CORE	061605095	1		
FL22	FERRITE CORE	061605095	1		
FL30	FERRITE CORE	061605095	1		AC INLET SASSY

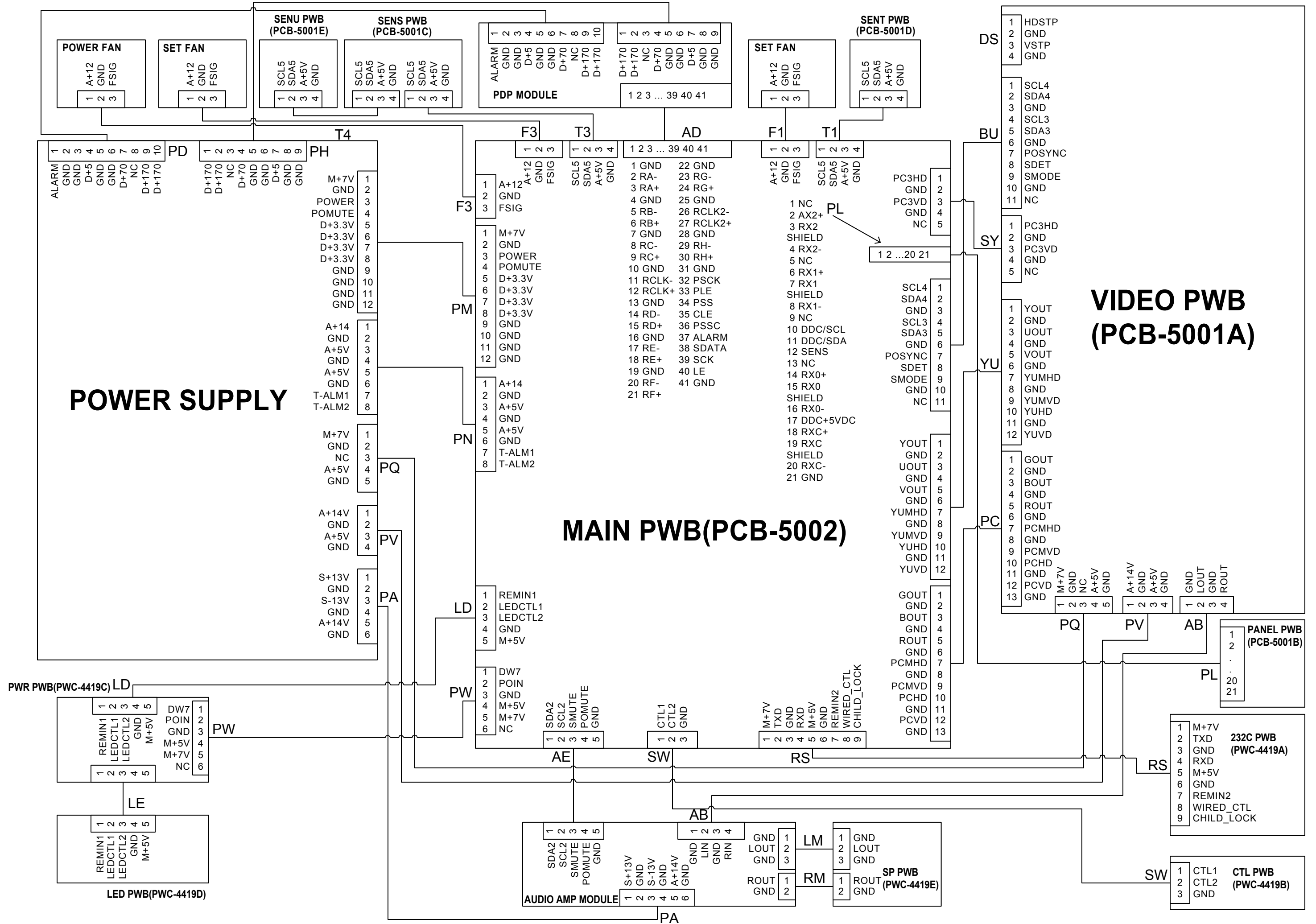
SYMBOL	PARTS NAME	PARTS NO.	Q'TY	NOTE
FL31	FERRITE CORE ZCAT2032-93	061605059	1	AC INLET SASSY
FL32	FERRITE CORE(ESD-R-19)	061605166	1	AC INLET SASSY
FL33	FERRITE CORE ZCAT2032-93	061605059	1	
FL35	FERRITE CORE ZCAT2032-93	061605059	1	
FL36	FERRITE CORE ZCAT2032-93	061605059	1	
FL37	FERRITE CORE ZCAT2032-93	061605059	1	
FL38	FERRITE CORE ZCAT2032-93	061605059	1	
FL5	FERRITE CORE ZCAT2032-93	061605059	1	
FL6	FERRITE CORE ZCAT2032-93	061605059	1	
FL7	FERRITE CORE ZCAT2032-93	061605059	1	
E01	FAN MOTOR 109P1212L4D03	03S170001	2	
E02	FAN MOTOR 109P1212L4D04	03S170002	1	
E03	CONNECTOR	073300126	1	
E04	AC INLET 10GEEG3C	06S760006	1	AC INLET SASSY
E05	CABLE 2P L240	07S530014	1	AC INLET SASSY
E06	CABLE 1P L360	07S530015	1	AC INLET SASSY
*** MECHANISM PARTS ***				
SRW01	CBIPS*4*12*3KF	024N03711	31	
SRW02	CBIPS*4*12*3KF	024N03711	1	
SRW03	CBIPS*4*12*3KF	024N03711	2	
SRW04	TP-M4*8*3KF	024N04591	12	
SRW05	TP-M4*8*3KF	024N04591	12	
SRW06	TP-M4*8*3KF	024N04591	8	
SRW07	TP-M4*8*3KF	024N04591	11	
SRW08	TP-M4*8*3KF	024N04591	9	
SRW09	TP-M4*8*3KF	024N04591	8	
SRW10	TP-M4*8*3KF	024N04591	9	
SRW11	TP-M4*8*3KF	024N04591	2	
SRW12	TP-M4*8*3KF	024N04591	3	
SRW13	PL-CPIMS*4*12*15KF	0910E4033	54	
SRW14	PL-CPIMS*4*12*15KF	0910E4033	8	
SRW15	PL-CPIMS*4*12*15KF	0910E4033	4	
SRW16	TP-M3*6*3KF	024N04581	7	
SRW17	TP-M3*6*3KF	024N04581	5	
SRW18	TP-M3*6*3KF	024N04581	3	
SRW19	TP-M3*6*3KF	024N04581	4	
SRW20	TP-M3*6*3KF	024N04581	11	
SRW21	TP-M3*6*3KF	024N04581	4	
SRW22	TP-M3*6*3KF	024N04581	1	
SRW23	TP-M3*6*3KF	024N04581	2	
SRW24	TP-M3*6*3KF	024N04581	1	
SRW25	TP-M3*6*3KF	024N04581	2	
SRW26	CBIPS*3*8*3KF	024N03691	8	
SRW27	CBIPS*3*8*3KF	024N03691	2	
SRW28	SCREW(D-SUB)	024N03112	2	
SRW29	SCREW(D-SUB)	024N03112	2	
SRW30	SCREW(D-SUB)	024N03112	2	
SRW31	TP-M4*8*3KF	024N04591	6	
SRW32	PL-CPIMS*4*12*15KF	0910E4033	4	
SRW33	TP-M4*8*3KF	024N04591	10	
M01	BRACKET(AD)	029F00171	1	

SYMBOL	PARTS NAME	PARTS NO.	Q'TY	NOTE
M02	BRACKET(AUDIO)ASSY	029HS0251	1	
M03	BRACKET(BOTTOM)	029H00431	2	
M04	BRACKET(FAN)PS	029H00481	1	
M05	BRACKET(FOOT)	029P00351	2	
M06	BRACKET(MAIN)ASSY	029HS0261	1	
M07	BRACKET(PS)ASSY	029HS0241	1	
M08	BRACKET(SP)	029P00301	1	
M09	C/L BUTTON	024G05221	1	
M10	CHASSIS	029H00341	1	
M11	CLAMP(LCT-1S)	029C00551	1	
M12	COVER(BOTTOM-L)ASSY	029PS0421	1	
M13	COVER(BOTTOM-R)ASSY	029PS0431	1	
M14	COVER(MAIN)	029H00451	1	
M15	COVER(SW)	029FS0031	1	
M16	CUSHION(FILTER)	029J00171	6	
M17	EDGING SADDLE(EDS-1208U)	029C00461	2	
M18	EDGING(TE-012)	029C00541	1	
M19	ET-CBIMS*4*8*3KF	024N04001	1	
M20	FILTER	029KS0051	1	
M21	FRONT PANEL ASSY	029DS0101	1	
M22	GASKET(L430*6*T6)	029C00681	1	
M23	INNER FRONT	029H00351	1	
M24				UNUSED
M25				UNUSED
M26	NAME PLATE(60XM1G)	029L00551	1	NSP
M27	PL-CPIMS*6*20*15KF	029N00101	12	
M28	REAR PANEL ASSY	029PS0291	1	
M29	SERIAL LABEL	024L44731	1	
M30	SHIELD PLATE(L)ASSY	029HS0271	1	
M31	SHIELD PLATE(R)ASSY	029HS0281	1	
M32	SHIELD PLATE(VIDEO)	029H00621	1	
M33	TERMINAL PANEL(PS)	029P00341	1	
M34	TERMINAL PANEL(VIDEO)	029P00331	1	
M35	EDGE SADDLE	024C04371	2	
M36				UNUSED
M37	BAND (L=100)	024280701	1	
M38	SCREW,P-CPIMS*3*14*3KF	024850121	2	
M39	PL-CPIMS*3*30*3KF	0910E3196	6	
M40	BUTTON(PWR)	024G05211	1	
M41	CLAMPER,WIRE	012281301	15	
M42	LEAD CLAMPER(D5.2)	024C00091	3	
M43	CLAMPER,WIRE (D8.3)	024C00101	1	
M44	SUPPLEMET SHEET EU(PDP)	078038511	1	
M45	PL-CPIMS*3*10*15KF	0910E3063	2	
M46	BARRIER(INLET)	024J15941	1	AC INLET SASSY
M47	CONNECTOR-BOLT(60)	024N04431	4	
M48	LEGS(STAND)	024J12331	29	
*** PRINTED & PACKING MATERIALS ***				
FL40	FERRITE CORE ZCAT2032-930	061605059	1	
FL41	FERRITE CORE ZCAT2032-930	061605059	1	
FL42	CORE,FERRITE SFT-72SB	06S170002	1	

SYMBOL	PARTS NAME	PARTS NO.	Q'TY	NOTE
FL43	CORE,FERRITE SFT-72SB	06S170002	1	
PSC	POWER CORD E3 L3 M L	070800089	1	
PK01	STOPPER	024282431	2	
PK02	BAG,POLYETHYLENE(150*370)	024813191	1	
PK03	JOINT	024CS0551	4	
PK04	PROTECTION SHEET	029M00231	1	
PK05	CARTON BOX(T)G	029MS0491	1	
PK06	CARTON BOX(B)	029MS0441	1	
PK07	INNER CARTON	029MS0451	2	
PK08	INNER TOP	029MS0461	1	
PK09	INNER PILLAR	029MS0471	2	
PK10	ACCESSORY BOX(61XM1G)	029MS0521	1	
PK11	CUSHION(TL)	029MS0531	1	
PK12	CUSHION(TR)	029MS0541	1	
PK13	CUSHION(TC)	029MS0551	1	
PK14	CUSHION(BL)	029MS0561	1	
PK15	CUSHION(BR)	029MS0571	1	
PK16	CUSHION(BC)	029MS0581	1	
PK17	CUSHION(BTM-L)	029MS0591	1	
PK18	CUSHION(BTM-R)	029MS0601	1	
PK19	CUSHION(SIDE)A	029MS1351	2	
PK20	CUSHION(SIDE)B	029MS1361	2	
PK21	REM-T HAND UNIT RP-100	03S120002	1	
PK22	BATTERY,DRY CELL UM-4*2	068001007	2	
PK23				UNUSED
PK24	PLUG CABLE (4M)	073499229	1	
PK25	CABLE,D-SUB 15P L1800	07S580001	1	
PK26	EYEBOLTS-M8*15KF	029N00111	2	
PK27	WARRANTY ENVELOPE(100*220)	078047921	1	
PK28	BAG,POLYETHYLENE(270*382)	024M14211	1	
PK29	NOTICE SHEET EU(PDP)	078038631	1	
PK30	USER'S MANUAL PX-61XMG	07S800271	1	
PK31				UNUSED
PK32				UNUSED
PK33				UNUSED
PK34	BAR CODE SERIAL LABEL	016761791	1	

CONNECTION DIAGRAMS

CONNECTION DIAGRAMS



Between PWBs	Connector name	Pin No.	Signal name	Acronym	Complementary description	Signal direction
MAIN-VIDEO	DS	1	HDSTP	Video mute control of chroma signal	LO when DS connector is available, and video output is generated. HI in case of no video output, and video mute takes place. LO when DS connector is available, and video output is generated. HI in case of no video output, and video mute takes place.	
		2	GND	GND		
		3	VSTP	Video mute control of video signal		
		4	GND	GND		
MAIN-VIDEO	BU	1	SCL4	CLK of the I2C bus	For extension I/O For extension I/O For VIDEO decoding, 3DYC separation, and 3LYC separation For VIDEO decoding, 3DYC separation, and 3LYC separation Power ON with HI Presence of S terminal identified with HI Usually LO. S1: 5V, S2:2.5V	MAIN → VIDEO MAIN → VIDEO MAIN → VIDEO MAIN → VIDEO MAIN → VIDEO VIDEO → MAIN VIDEO → MAIN
		2	SDA4	DATA of the I2C bus		
		3	GND	GND		
		4	SCL3	CLK of the I2C bus		
		5	SDA3	DATA of the I2C bus		
		6	GND	GND		
		7	POSYNC	Power ON/OFF control signal for power management		
		8	SDET	Insertion detect signal for the S terminal		
		9	SMODE	Mode detect signal for the S1/S2		
		10	GND	GND		
		11	NC	No-connection terminal		
MAIN-VIDEO	SY	1	PC3HD	Horizontal sync signal for PC signal (digital input)	Horizontal sync signal for PC signal of digital input Vertical sync signal for PC signal of digital input	MAIN → VIDEO MAIN → VIDEO
		2	GND	GND		
		3	PC3VD	Vertical sync signal for PC signal (digital input)		
		4	GND	GND		
		5	NC	No-connection terminal		
MAIN-VIDEO	YU	1	YOUT	Chroma Y signal or VIDEO G signal	For the chroma signal, input signal is immediately output. For the video signal, each decoded original color signal is output. For the chroma signal, input signal is immediately output. For the video signal, each decoded original color signal is output. For the chroma signal, input signal is immediately output. For the video signal, each decoded original color signal is output.	VIDEO → MAIN VIDEO → MAIN VIDEO → MAIN
		2	GND	GND		
		3	UOUT	Chroma B-Y signal or VIDEO B signal		
		4	GND	GND		
		5	VOUT	Chroma R-Y signal or VIDEO R signal		
		6	GND	GND		

Between PWBs	Connector name	Pin No.	Signal name	Acronym	Complementary description	Signal direction		
MAIN-VIDEO	PC	7	YUMHD	Horizontal sync signal for microcomputer	Horizontal sync signal input to be entered in microcomputer when a chroma or video signal is used.	VIDEO → MAIN		
		8	GND	GND	Vertical sync signal input to be entered in microcomputer when a chroma or video signal is used.	VIDEO → MAIN		
		9	YUIMVD	Vertical sync signal for microcomputer	Vertical sync signal input to be entered in microcomputer when a chroma or video signal is used.	VIDEO → MAIN		
		10	YUHD	Horizontal sync signal for A/D	Horizontal sync signal input to be entered in A/D converter when a chroma or video signal is used.	VIDEO → MAIN		
		11	GND	GND	Vertical sync signal for A/D	VIDEO → MAIN		
		12	YUVD	Vertical sync signal for A/D	Vertical sync signal input to be entered in A/D converter when a chroma or video signal is used.	VIDEO → MAIN		
		1	GOUT	Signal G of PC	For the PC signal, an input signal is immediately output.	VIDEO → MAIN		
		2	GND	GND	For the PC signal, an input signal is immediately output.	VIDEO → MAIN		
		3	BOUT	Signal B of PC	For the PC signal, an input signal is immediately output.	VIDEO → MAIN		
		4	GND	GND	For the PC signal, an input signal is immediately output.	VIDEO → MAIN		
		5	ROUT	Signal R of PC	For the PC signal, an input signal is immediately output.	VIDEO → MAIN		
		6	GND	GND	Horizontal sync signal for microcomputer	VIDEO → MAIN		
		7	PCMHD	Horizontal sync signal for microcomputer	Horizontal sync signal input to be entered in microcomputer of the PC signal.	VIDEO → MAIN		
VIDEO-POWER SUPPLY	PQ	8	GND	GND	Vertical sync signal input to be entered in microcomputer of the PC signal.	VIDEO → MAIN		
		9	PCMVD	Vertical sync signal for microcomputer	Vertical sync signal input to be entered in microcomputer of the PC signal.	VIDEO → MAIN		
		10	PCHD	Horizontal sync signal for A/D	Horizontal sync signal input to be entered in the A/D of the PC signal.	VIDEO → MAIN		
		11	GND	GND	Vertical sync signal input to be entered in the A/D of the PC signal	VIDEO → MAIN		
		12	PCVD	Vertical sync signal for the A/D	Vertical sync signal input to be entered in the A/D of the PC signal	VIDEO → MAIN		
		13	GND	GND		VIDEO → MAIN		
		1	M+7V	7V power supply for microcomputer	For the sync detector circuit to be used for the recovery from the power management	POWER → VIDEO		
		2	GND	GND		POWER → VIDEO		
		3	NC	No-connection terminal		POWER → VIDEO		
		4	A+5V	5V power supply for analog circuit	For analog signal processing	POWER → VIDEO		
		5	GND	GND		POWER → VIDEO		
		VIDEO-POWER SUPPLY	PV	1	A+14V	14V power supply for analog circuit	For analog signal processing	POWER → VIDEO
				2	GND	GND		POWER → VIDEO
3	A+5V			5V power supply for analog circuit	For analog signal processing	POWER → VIDEO		
4	GND			GND		POWER → VIDEO		

Between PWBs	Connector name	Pin No.	Signal name	Acronym	Complementary description	Signal direction
VIDEO-AUDIO	AB	1	GND	GND	Audio signal L CH	VIDEO → AUDIO
		2	LOUT	Signal L		
		3	GND	GND		
		4	ROUT	Signal R		VIDEO → AUDIO
RS232C-MAIN	RS	1	M+7V	7V power supply; the same as for microcomputer	Usually 5V. 0V when inserted. 0V for SW OFF. 5V for SW ON.	MAIN → RS232C
		2	TXD	RS-232 driver output		MAIN → RS232C
		3	GND	GND		
		4	RXD	RS-232 receiver input		MAIN → RS232C
		5	M+5V	5V power supply; the same as for microcomputer		MAIN → RS232C
		6	GND	GND		
		7	REMIN2	Data signal for the wired remote control		RS232C → MAIN
		8	WIRED_CTL	Insertion control of the wired remote control		RS232C → MAIN
		9	CHILD_LOCK	Child lock control		RS232C → MAIN
MAIN-SET FAN	F1	1	A+12V	12V power supply for ANALOG	0V	MAIN → FAN
		2	GND	GND		FAN → MAIN
		3	FSIG	FAN alarm signal		
MAIN-SENT MAIN-SENS MAIN-SENU	T1 T3 T4	1	SCL5	CLK of the I2C bus	For temperature sensor For temperature sensor	MAIN → SENS
		2	SDA5	DATA of the I2C bus		MAIN → SENS
		3	A+5V	12V power supply for ANALOG		MAIN → SENS
		4	GND	GND		
MAIN-PDP MODULE	AD	1	GND	GND		MAIN → PDPMODULE
		2	RA-	VIDEO input A-		MAIN → PDPMODULE
		3	RA+	VIDEO input A+		
		4	GND	GND		
		5	RB-	VIDEO input B-		MAIN → PDPMODULE
		6	RB+	VIDEO input B+		MAIN → PDPMODULE
		7	GND	GND		
		8	RC-	VIDEO input C-		MAIN → PDPMODULE
		9	RC+	VIDEO input C+		MAIN → PDPMODULE
		10	GND	GND		
		11	RCLK-	CKL- for VIDEO		MAIN → PDPMODULE
		12	RCLK+	CKL+ for VIDEO		MAIN → PDPMODULE
		13	GND	GND		
		14	RD-	VIDEO input D-		MAIN → PDPMODULE
		15	RD+	VIDEO input D+		MAIN → PDPMODULE
		16	GND	GND		
		17	RE-	VIDEO input E-		MAIN → PDPMODULE
		18	RE+	VIDEO input E+		MAIN → PDPMODULE

Between PWBs	Connector name	Pin No.	Signal name	Acronym	Complementary description	Signal direction
		19	GND	GND		MAIN → PDPMODULE
		20	RF-	VIDEO input F-		MAIN → PDPMODULE
		21	RF+	VIDEO input F+		MAIN → PDPMODULE
		22	GND	GND		MAIN → PDPMODULE
		23	RG-	VIDEO input G-		MAIN → PDPMODULE
		24	RG+	VIDEO input G+		MAIN → PDPMODULE
		25	GND	GND		MAIN → PDPMODULE
		26	RCLK2-	CKL2- for VIDEO		MAIN → PDPMODULE
		27	RCLK2+	CKL2+ for VIDEO		MAIN → PDPMODULE
		28	GND	GND		MAIN → PDPMODULE
		29	RH-	VIDEO input H-		MAIN → PDPMODULE
		30	RH+	VIDEO input H+		MAIN → PDPMODULE
		31	GND	GND		MAIN → PDPMODULE
		32	PSCK	CLK for power save data I/O		MAIN → PDPMODULE
		33	PLE	PSS read enable		MAIN → PDPMODULE
		34	PSS	Average signal level data output for power save		PDPMODULE → MAIN
		35	CLE	PSS latch enable		MAIN → PDPMODULE
		36	PSSC	Control data input for power save		MAIN → PDPMODULE
		37	ALARM	Panel break alarm signal		PDPMODULE → MAIN
		38	SDATA	Serial data for various data setting		MAIN → PDPMODULE
		39	SCK	Serial CLK		MAIN → PDPMODULE
		40	LE	Serial data latch enable		MAIN → PDPMODULE
		41	GND	GND		MAIN → PDPMODULE
MAIN-SENT	T2	1	SCL5	CLK of the I2C bus		MAIN → SENT
		2	SDA5	DATA of the I2C bus		MAIN → SENT
		3	A+5V	5V power supply for ANALOG signal		MAIN → SENT
		4	GND	GND		
MAIN-SENT FAN	T2	1	A+12V	12V power supply for ANALOG signal		MAIN → FAN
		2	GND	GND		
		3	FSIG	FAN alarm signal		FAN → MAIN
MAIN-POWER SUPPLY	PM	1	M+7V	7V power supply for microcomputer		POWER → MAIN
		2	GND	GND		
		3	POWER	Power supply control		POWER → MAIN
		4	POMUTE	Mute signal for power supply starting	Usually 3.7V	POWER → MAIN
		5	D+3.3V	3.3V power supply for DIGITAL signal	Usually 4.8V	POWER → MAIN
		6	D+3.3V	3.3V power supply for DIGITAL signal		POWER → MAIN
		7	D+3.3V	3.3V power supply for DIGITAL signal		POWER → MAIN
		8	D+3.3V	3.3V power supply for DIGITAL signal		POWER → MAIN
		9	GND	GND		
		10	GND	GND		
		11	GND	GND		
		12	GND	GND		

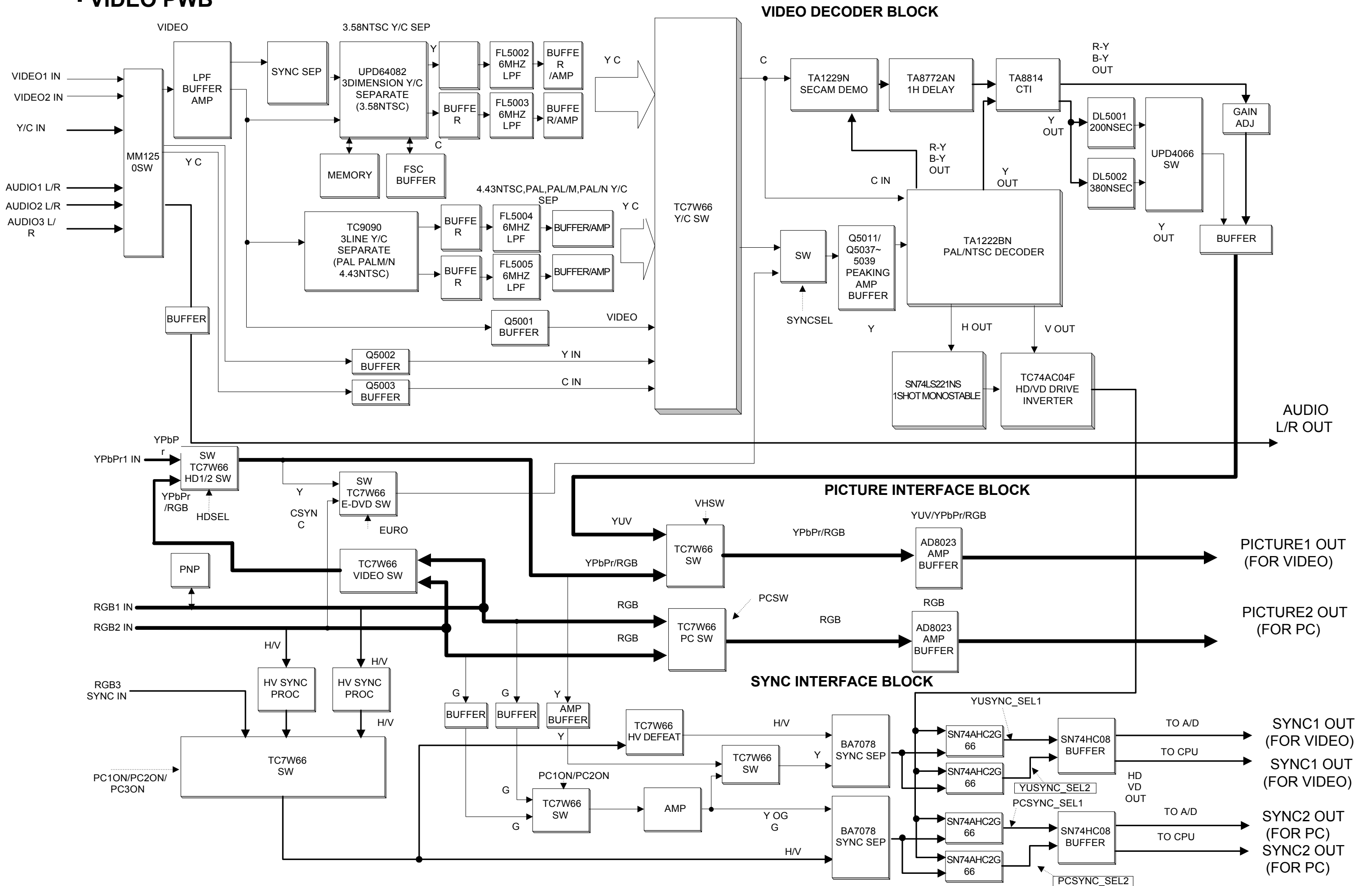
Between PWBs	Connector name	Pin No.	Signal name	Acronym	Complementary description	Signal direction
MAIN-POWER SUPPLY	PN	1	A+14V	14V power supply for ANALOG signal GND 5V power supply for ANALOG signal GND 5V power supply for ANALOG signal GND Alarm signal Alarm signal	Usually 5V Usually 5V	POWER → MAIN
		2	GND			POWER → MAIN
		3	A+5V			POWER → MAIN
		4	GND			POWER → MAIN
		5	A+5V			POWER → MAIN
		6	GND			POWER → MAIN
		7	T-ALM1			POWER → MAIN
		8	T-ALM2			POWER → MAIN
MAIN-LED	LD	1	REMIN1	Infrared ray remote control data Standby LED control Standby LED control GND 5V power supply for microcomputer		LED → MAIN
		2	LEDCTL1			MAIN → LED
		3	LEDCTL2			MAIN → LED
		4	GND			MAIN → LED
		5	M+5V			MAIN → LED
MAIN-PWR	PW	1	SW7	Power supply starting control Power supply starting detection GND 5V power supply for microcomputer 7V power supply for microcomputer No-connection terminal	Usually 6.8V Usually 5V	MAIN → PW
		2	POIN			PW → MAIN
		3	GND			MAIN → PW
		4	M+5V			MAIN → PW
		5	M+7V			MAIN → PW
		6	NC			MAIN → PW
MAIN-AUDIO	AE	1	SDA2	DATA of the I2C bus CLK of the I2C bus Audio mute Mute signal for power supply starting GND		MAIN → AUDIO
		2	SCL2			MAIN → AUDIO
		3	SMUTE			MAIN → AUDIO
		4	POMUTE			MAIN → AUDIO
		5	GND			MAIN → AUDIO
MAIN-SW	SW	1	CTL1	Key input detection Key input detection GND		SW → MAIN
		2	CTL2			SW → MAIN
		3	GND			
AUDIO-POWER SUPPLY	PA	1	S+13V	+13V power supply for audio circuit GND -13V power supply for audio circuit GND 14V power ANALOG circuit GND		POWER → AUDIO
		2	GND			POWER → AUDIO
		3	S-13V			POWER → AUDIO
		4	GND			POWER → AUDIO
		5	A+14V			POWER → AUDIO
		6	GND			POWER → AUDIO
POWER SUPPLY-PDP MODULE	PD	1	ALARM	Module alarm signal GND		MODULE → POWER
		2	GND			

Between PWBs	Connector name	Pin No.	Signal name	Acronym	Complementary description	Signal direction
		3	GND	GND		POWER → MODULE
		4	D+5V	5V power supply for DIGITAL circuit		POWER → MODULE
		5	GND	GND		POWER → MODULE
		6	GND	GND		POWER → MODULE
		7	D+70	70V power supply for DIGITAL circuit		POWER → MODULE
		8	NC	No-connection terminal		POWER → MODULE
		9	D+170	170V power supply for DIGITAL circuit		POWER → MODULE
		10	D+170	170V power supply for DIGITAL circuit		POWER → MODULE
POWER SUPPLY-PDP MODULE	PH	1	D+170	170V power supply for DIGITAL circuit		POWER → MODULE
		2	D+170	170V power supply for DIGITAL circuit		POWER → MODULE
		3	NC	No-connection terminal		POWER → MODULE
		4	D+70	70V power supply for DIGITAL circuit		POWER → MODULE
		5	GND	GND		POWER → MODULE
		6	GND	GND		POWER → MODULE
		7	D+5	5V power supply for DIGITAL circuit		POWER → MODULE
		8	GND	GND		POWER → MODULE
		9	GND	GND		POWER → MODULE
MIAN-PL (Note : MAIN PWB No. is applied to the PIN No.)	PL	1	NC	No-connection terminal		PL → MAIN
		2	RX2+	Serial signal R (+ side)		PL → MAIN
		3	GND	GND		PL → MAIN
		4	RX2-	Serial signal R (- side)		PL → MAIN
		5	NC	No-connection terminal		PL → MAIN
		6	RX1+	Serial signal G (+ side)		PL → MAIN
		7	GND	GND		PL → MAIN
		8	RX1-	Serial signal G (- side)		PL → MAIN
		9	NC	No-connection terminal		PL → MAIN
		10	DDC/SCL	CLK of the I2C bus for DDC writing		PL → MAIN
		11	DDC/SDA	DATA of the I2C bus for DDC writing		PL → MAIN
		12	SENS	Power supply detection		MAIN → PL
		13	NC	No-connection terminal		PL → MAIN
		14	RX0+	Serial signal B (+ side)		PL → MAIN
		15	GND	GND		PL → MAIN
		16	RX0-	Serial signal B (- side)		MAIN → PL
		17	DDC5V	5V power supply for DDC		PL → MAIN
		18	RXC+	CLK serial signal (+ side)		PL → MAIN
		19	GND	GND		PL → MAIN
		20	RXC-	CLK serial signal (- side)		PL → MAIN
		21	GND	GND		PL → MAIN

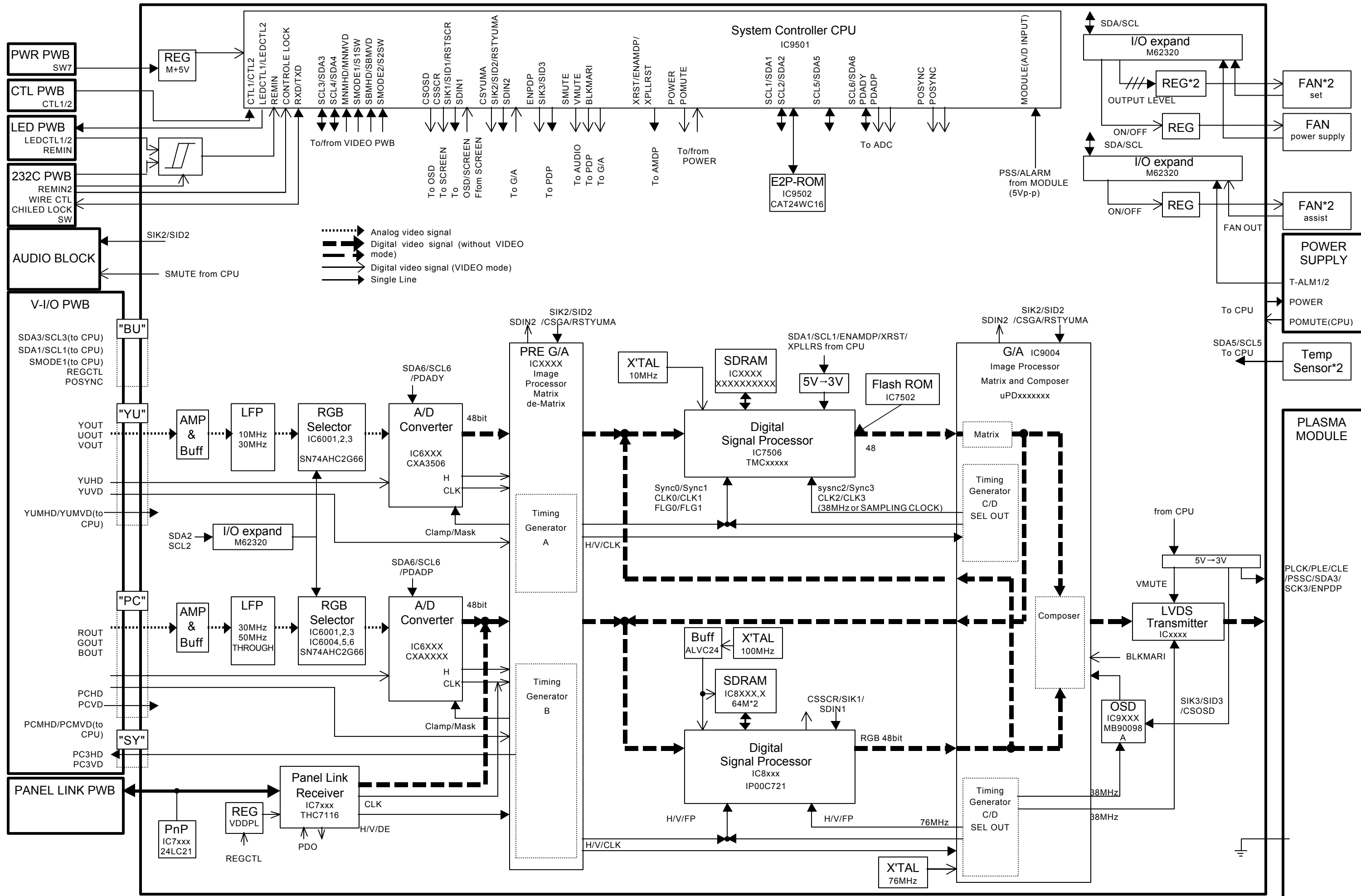
BLOCK DIAGRAMS

BLOCK DIAGRAM

· VIDEO PWB

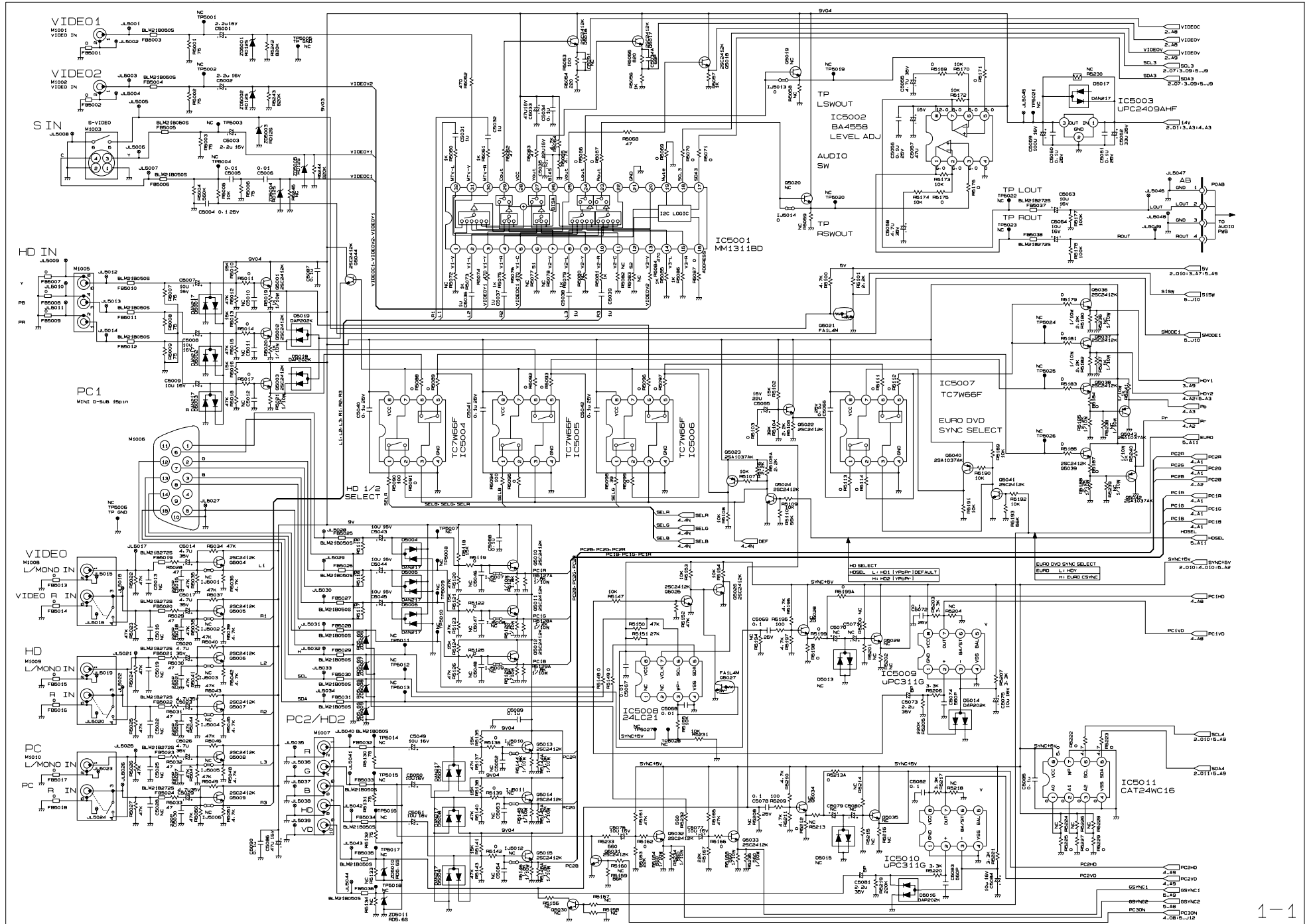


MAIN PWB



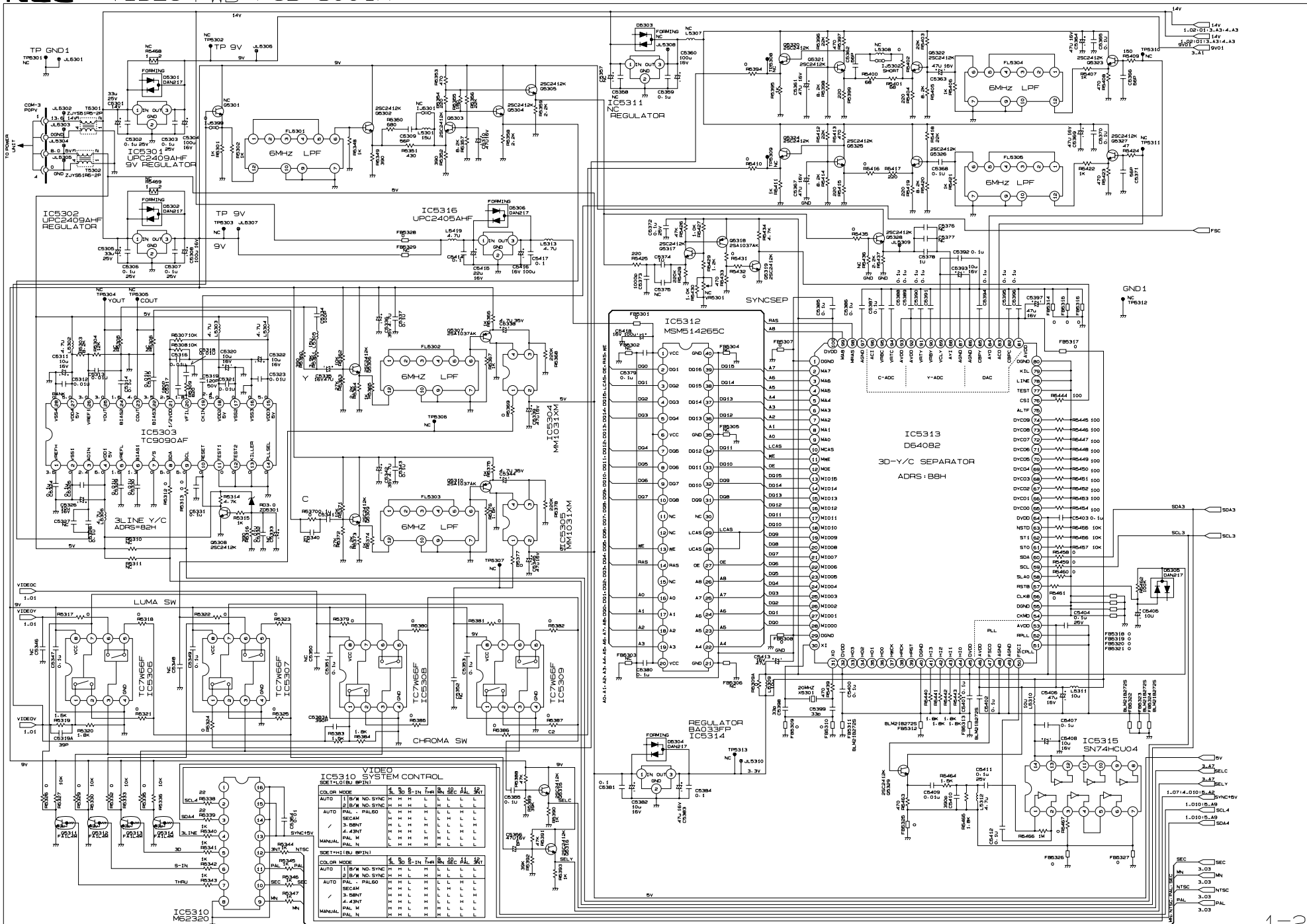
SCHEMATIC DIAGRAMS

NEC VIDEO PWB PCB-5001A

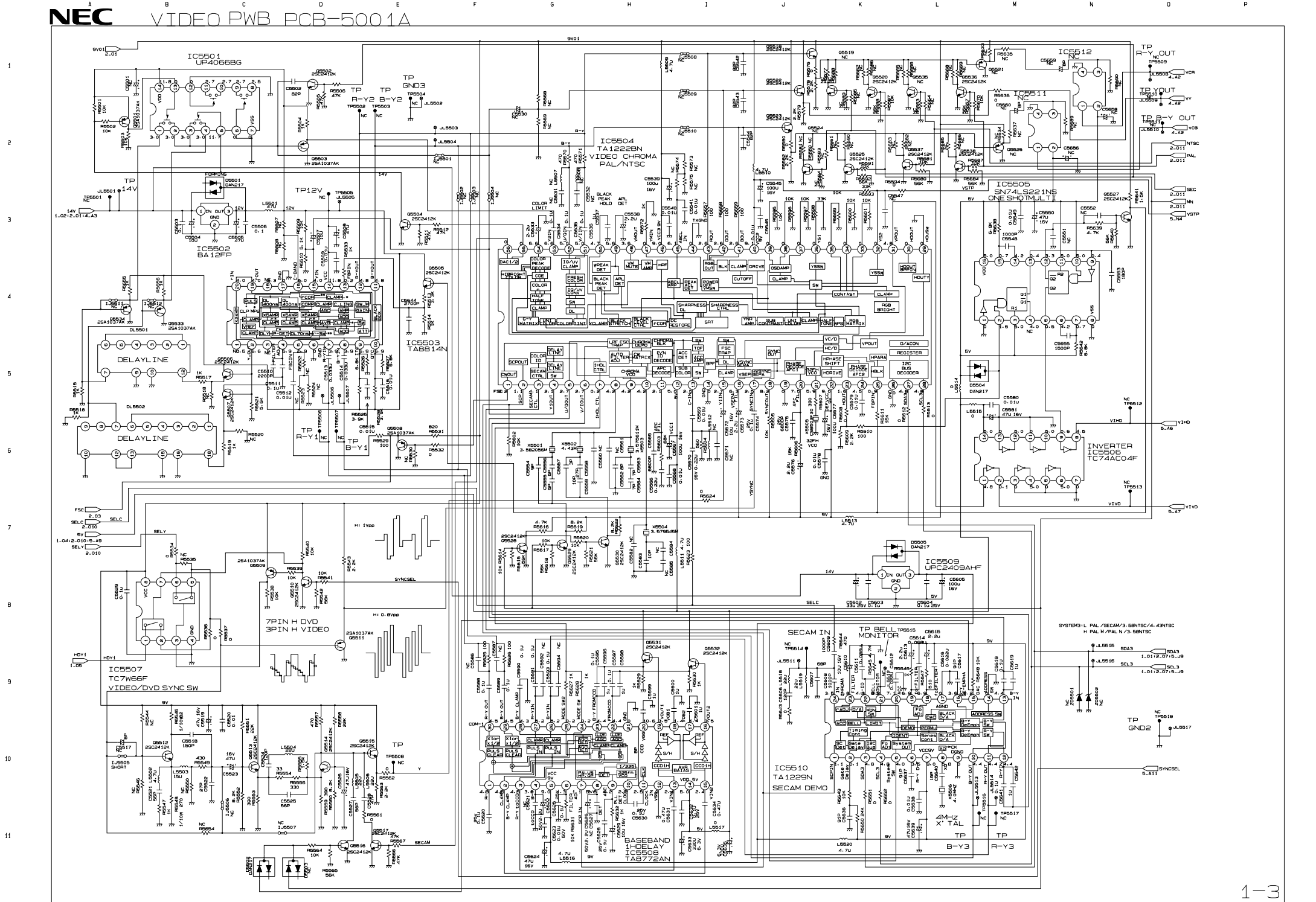


NEC VIDEO PWB PCB-5001A

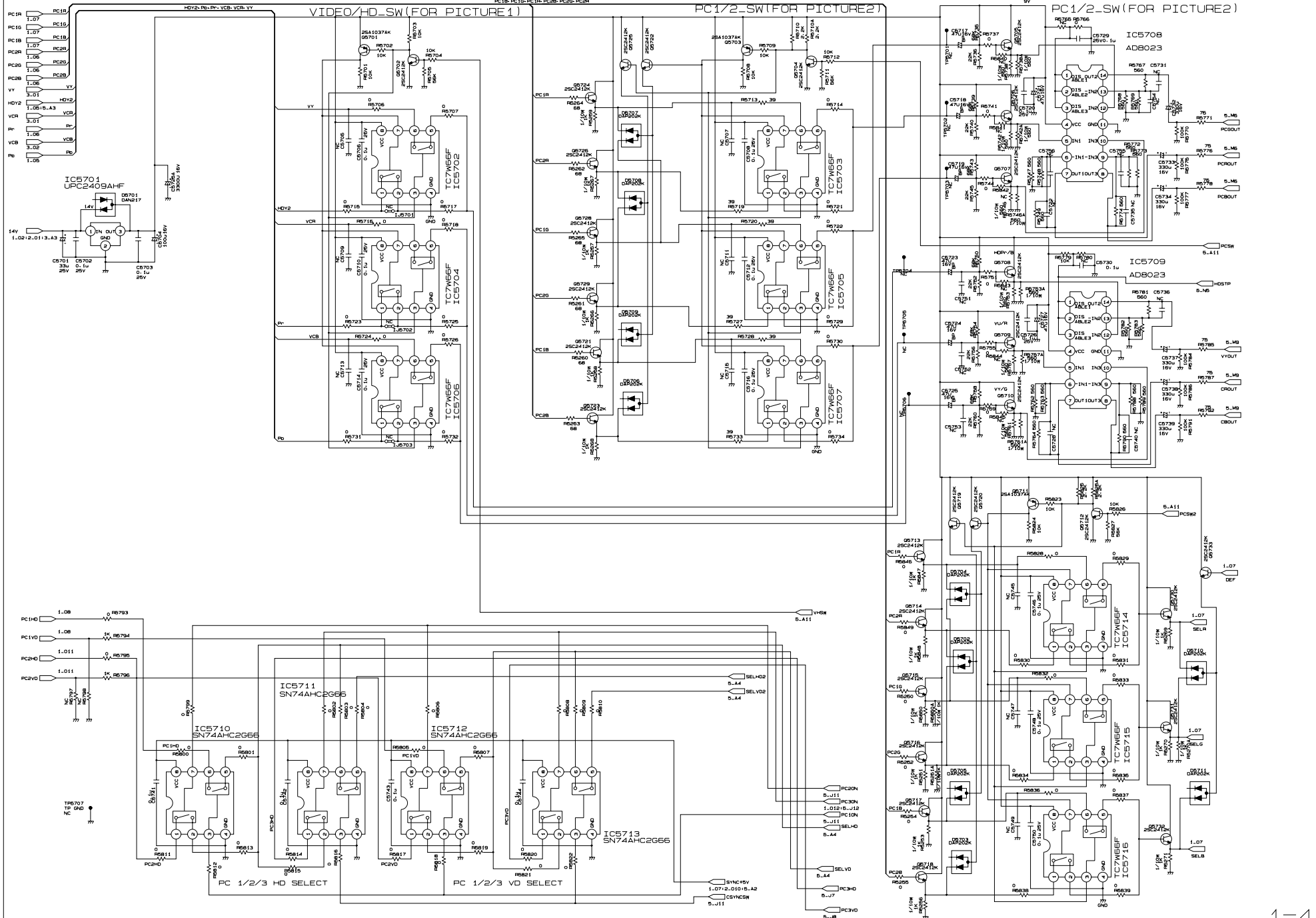
1
2
3
4
5
6
7
8
9
10
11



NEC VIDEO PWB PCB-5001A



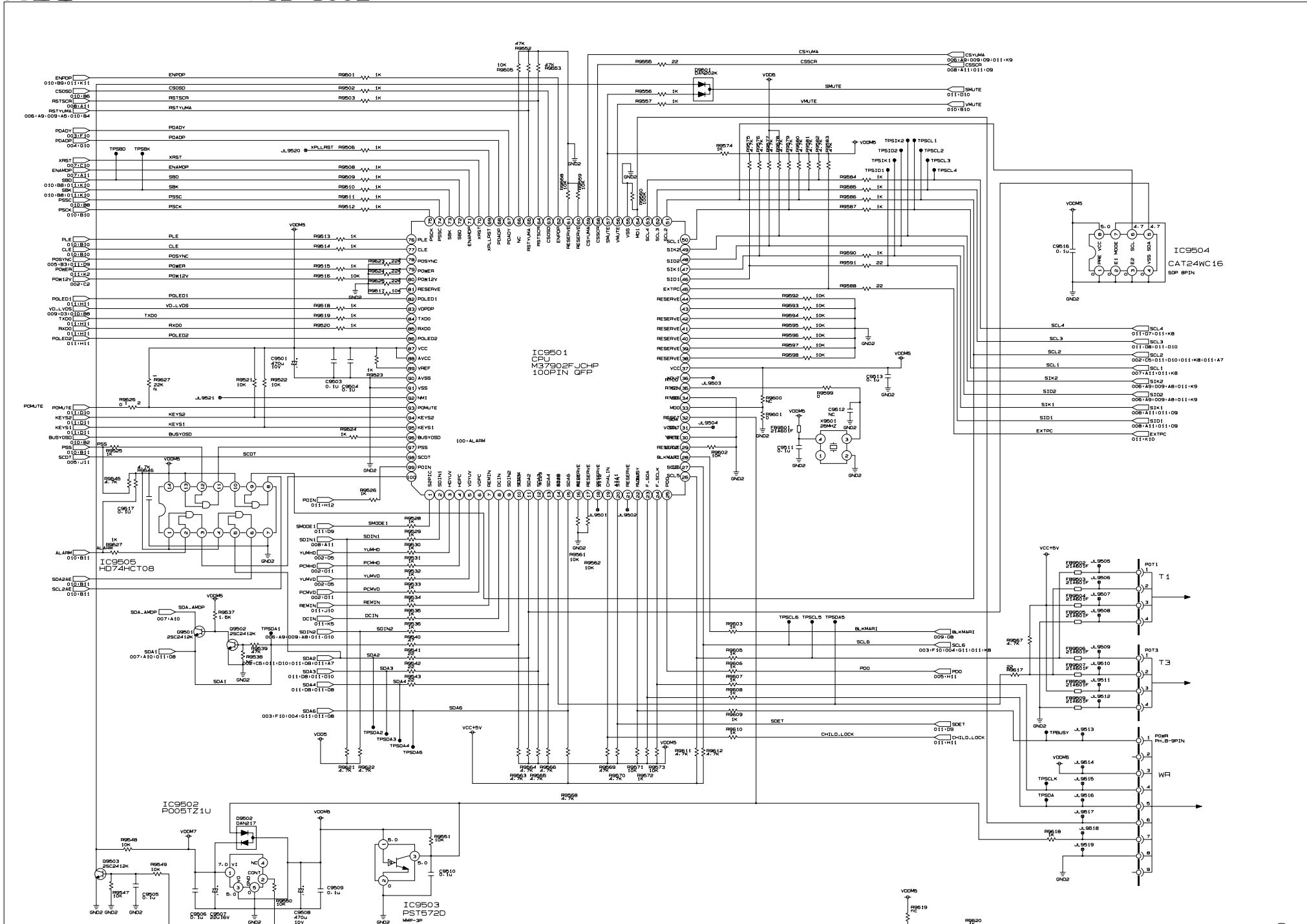
NEC VIDEO PWB PCB-5001A



NEC MAIN PWB PCB-5002

1
2
3
4
5
6
7
8
9
10
11

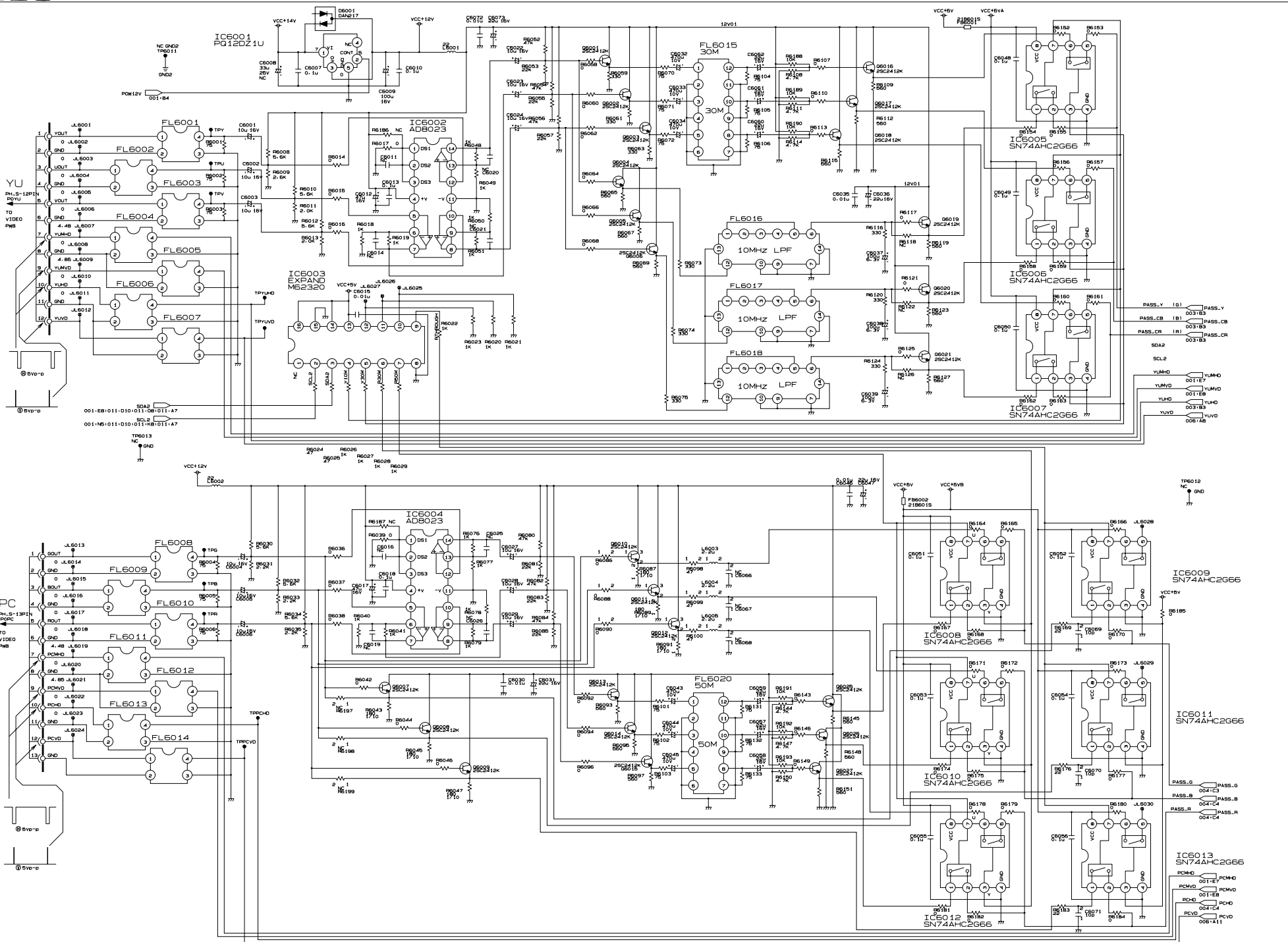
A B C D E F G H I J K L M N O P



NEC MAIN PWB PCB-5002

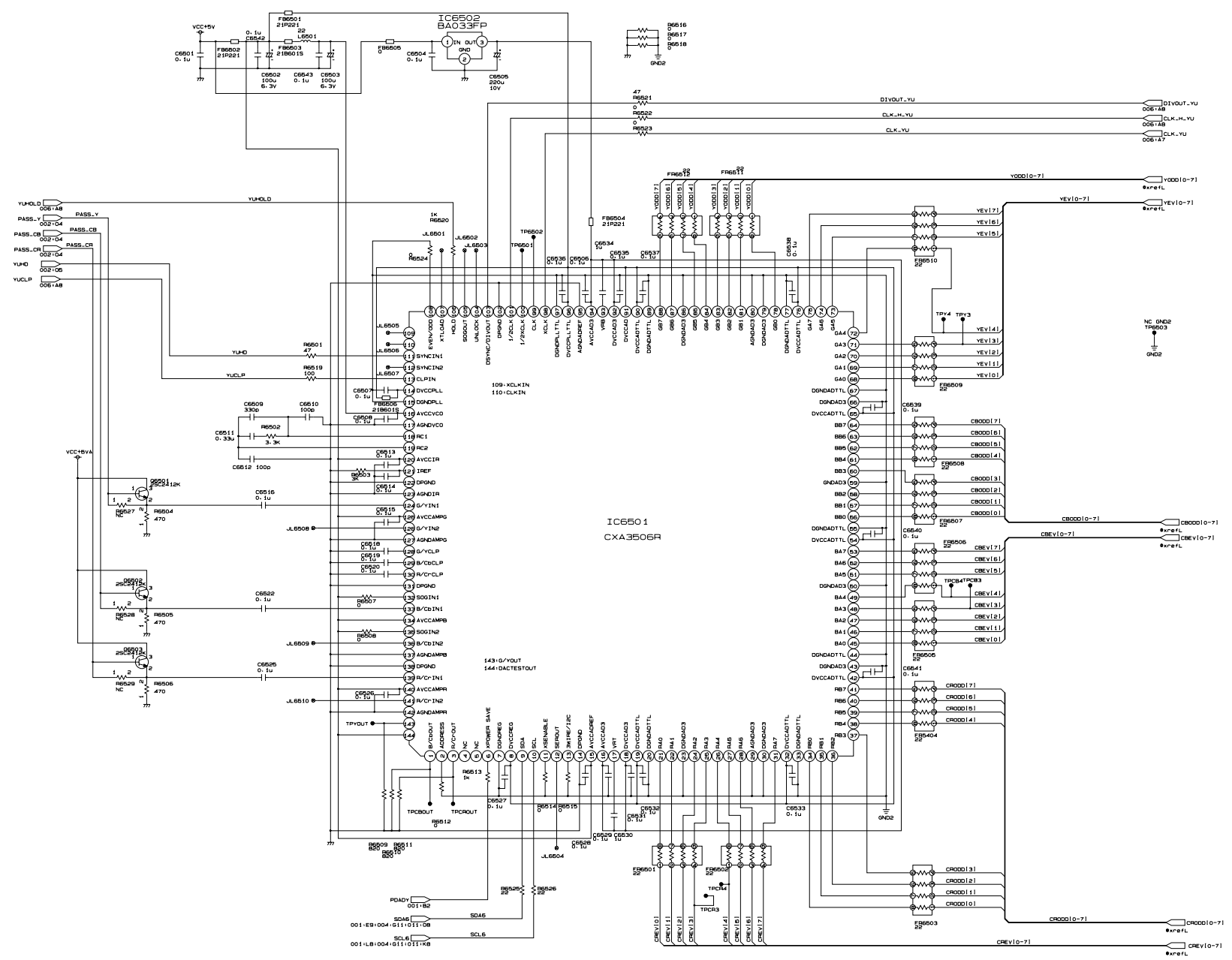
1
2
3
4
5
6
7
8
9
10
11

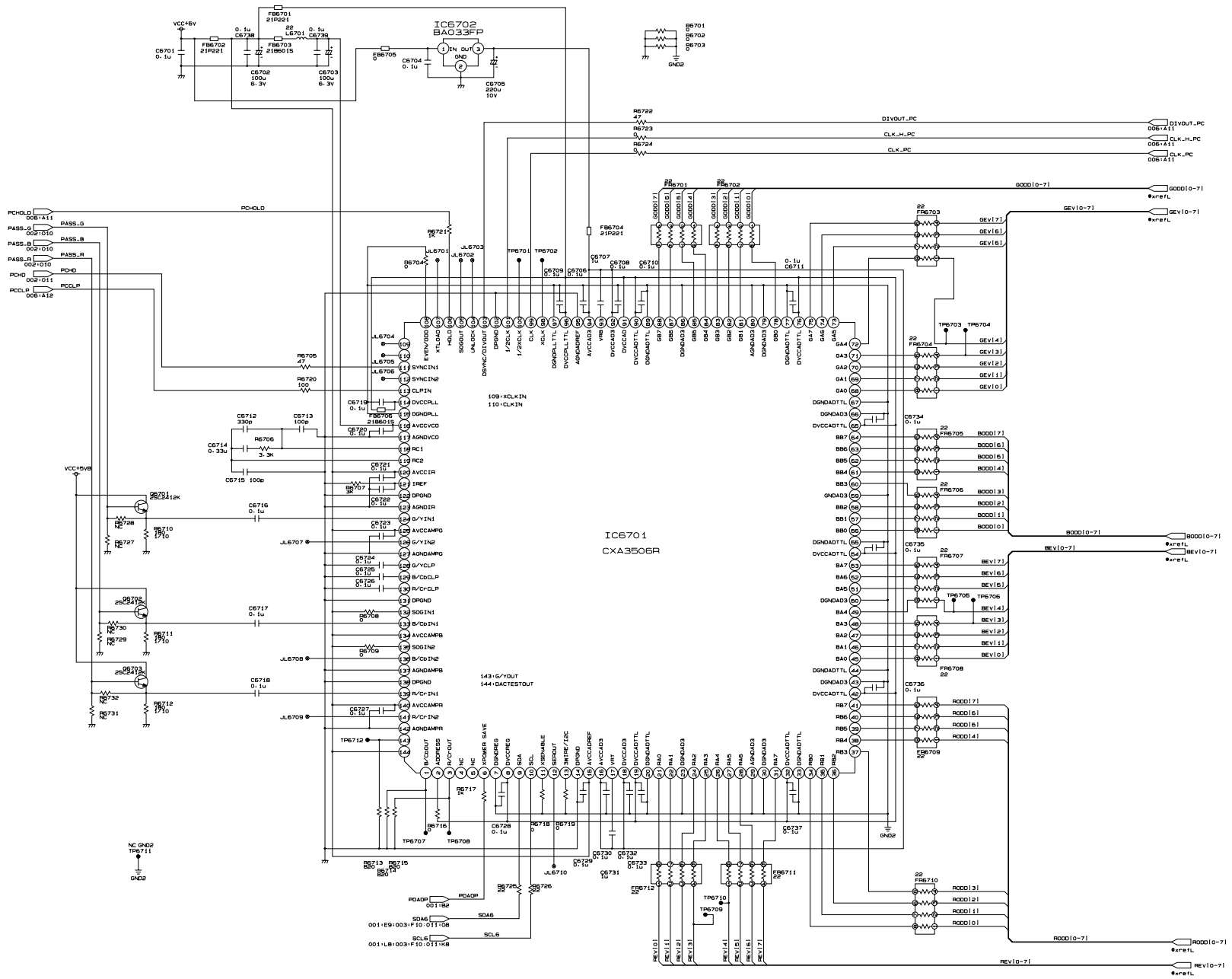
A B C D E F G H I J K L M N O P



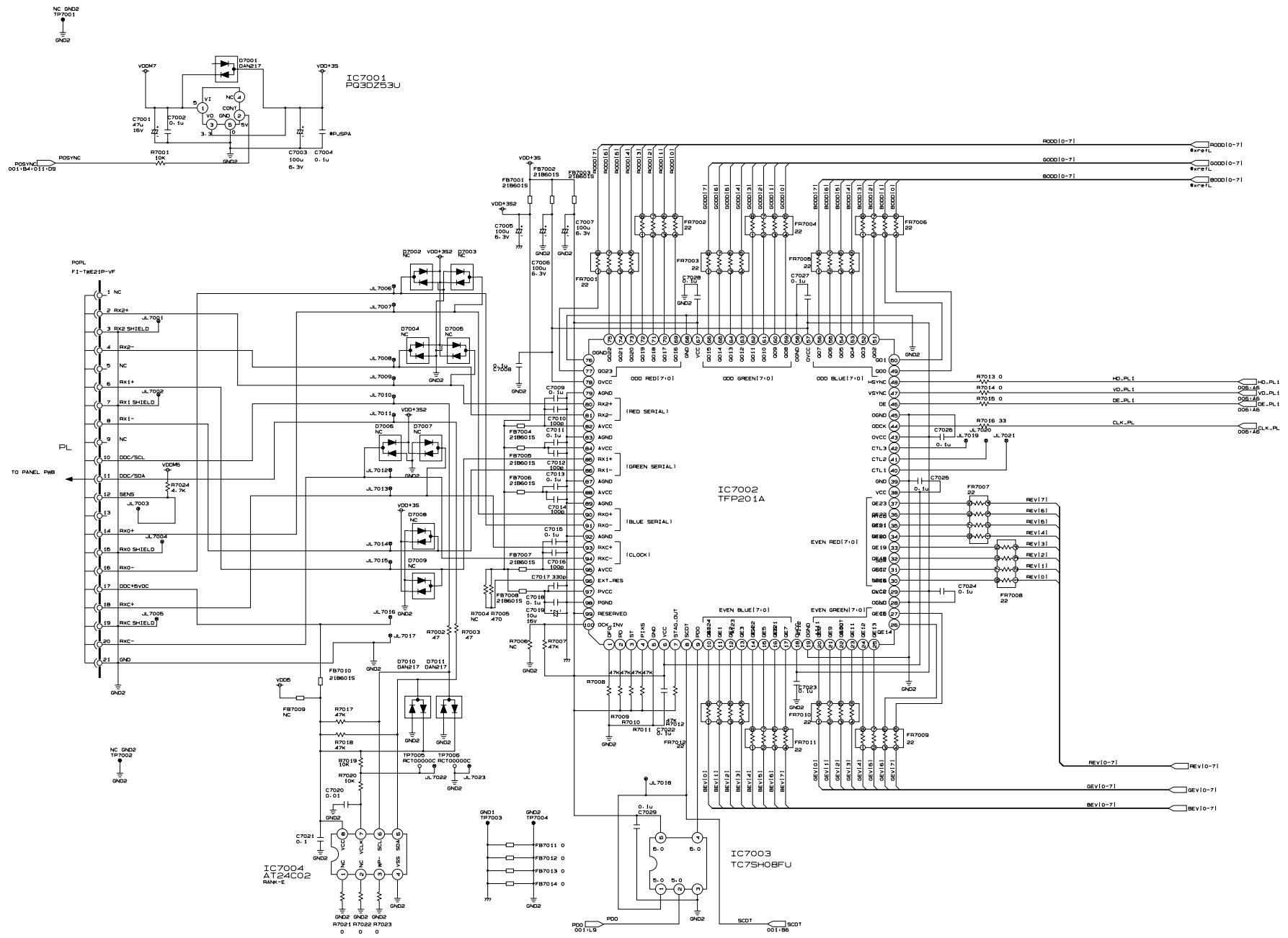
1
2
3
4
5
6
7
8
9
10
11

A B C D E F G H I J K L M N O P



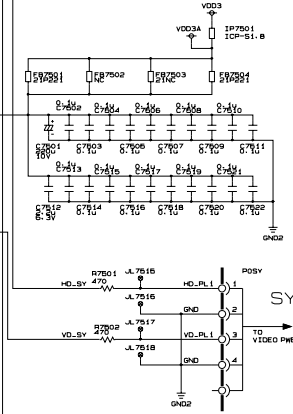
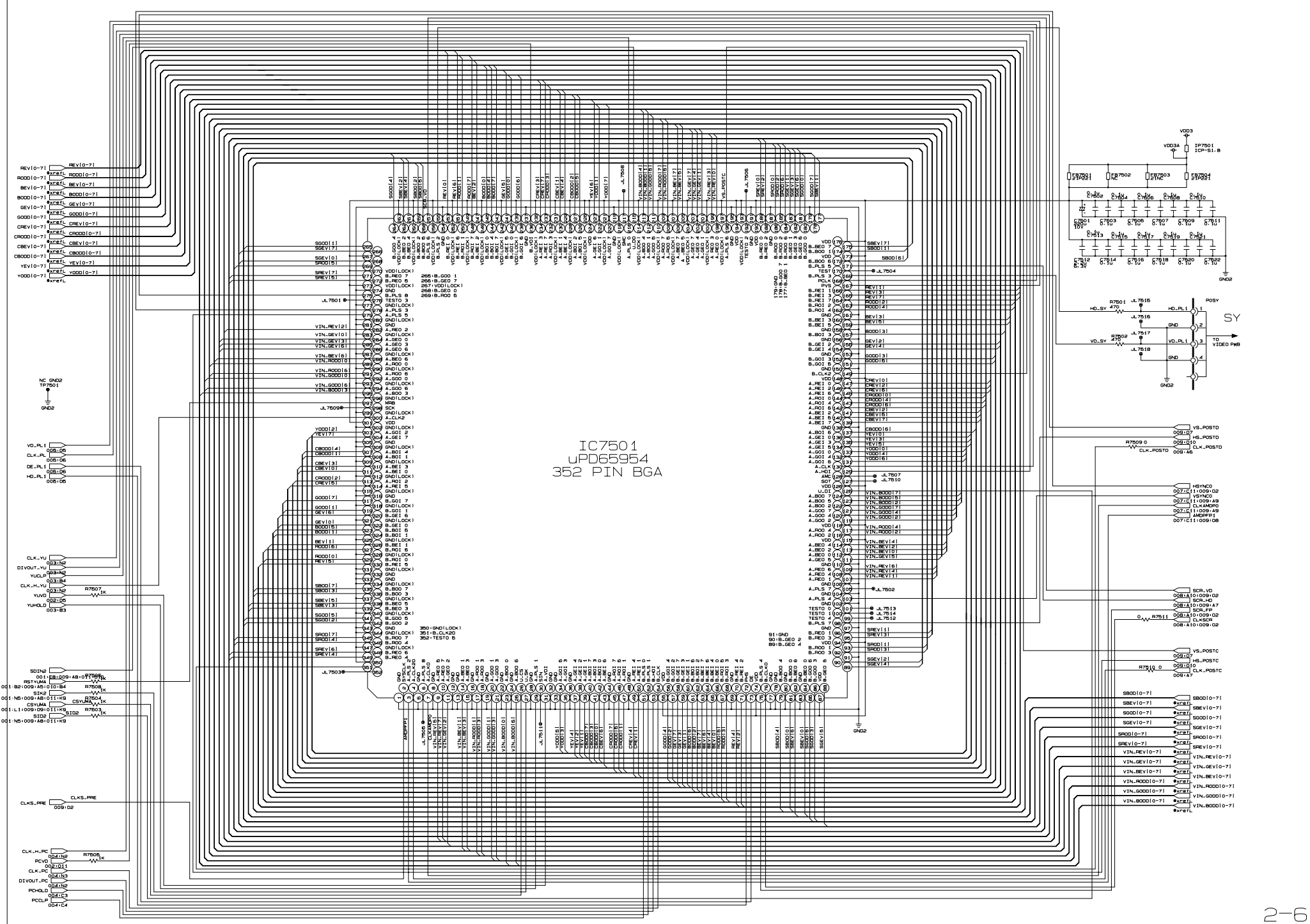


1
2
3
4
5
6
7
8
9
10
11



1
2
3
4
5
6
7
8
9
10
11

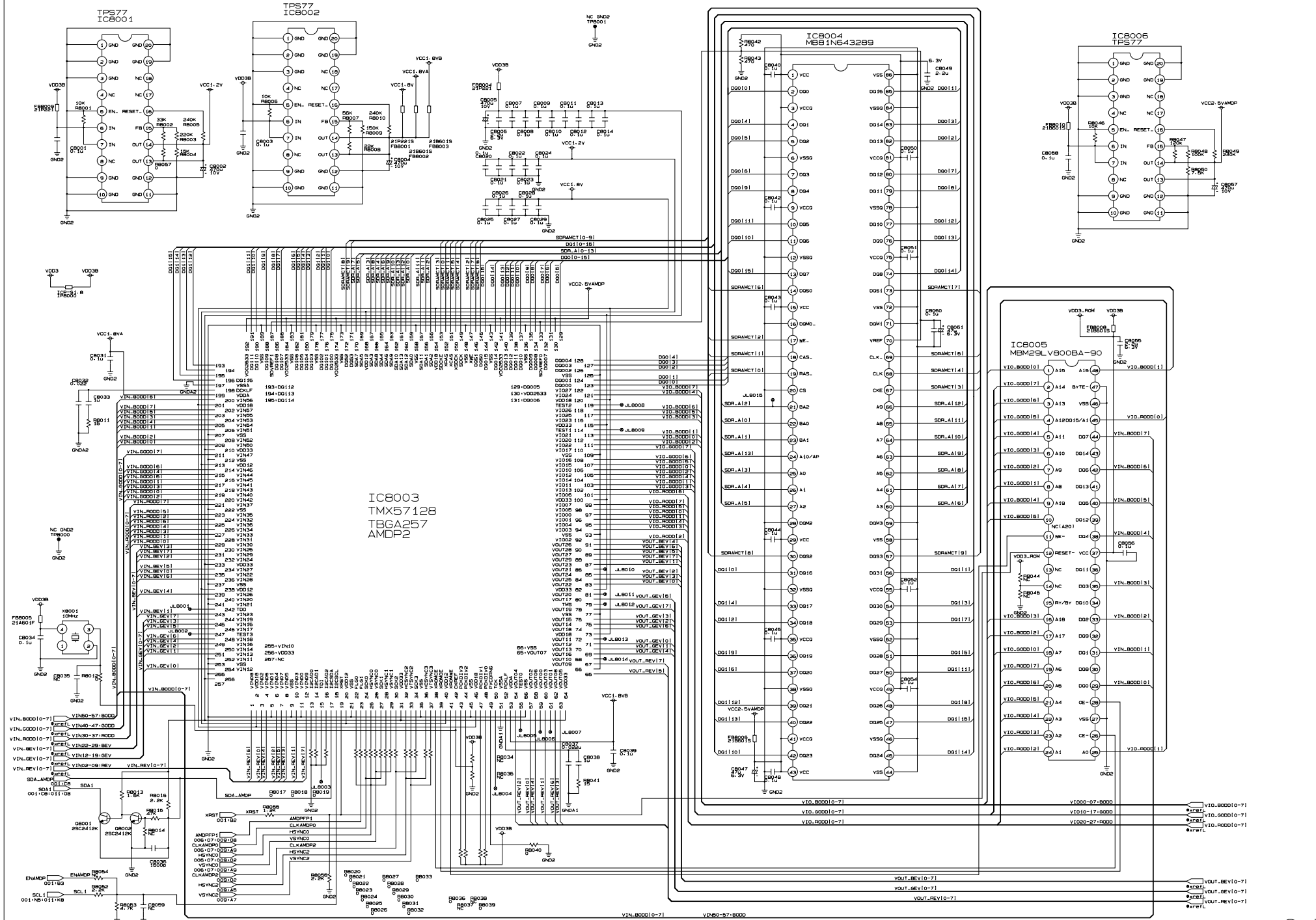
A B C D E F G H I J K L M N O P



IC7501
UPD65954
352 PIN BGA

NEC MAIN PWB PCB-5002

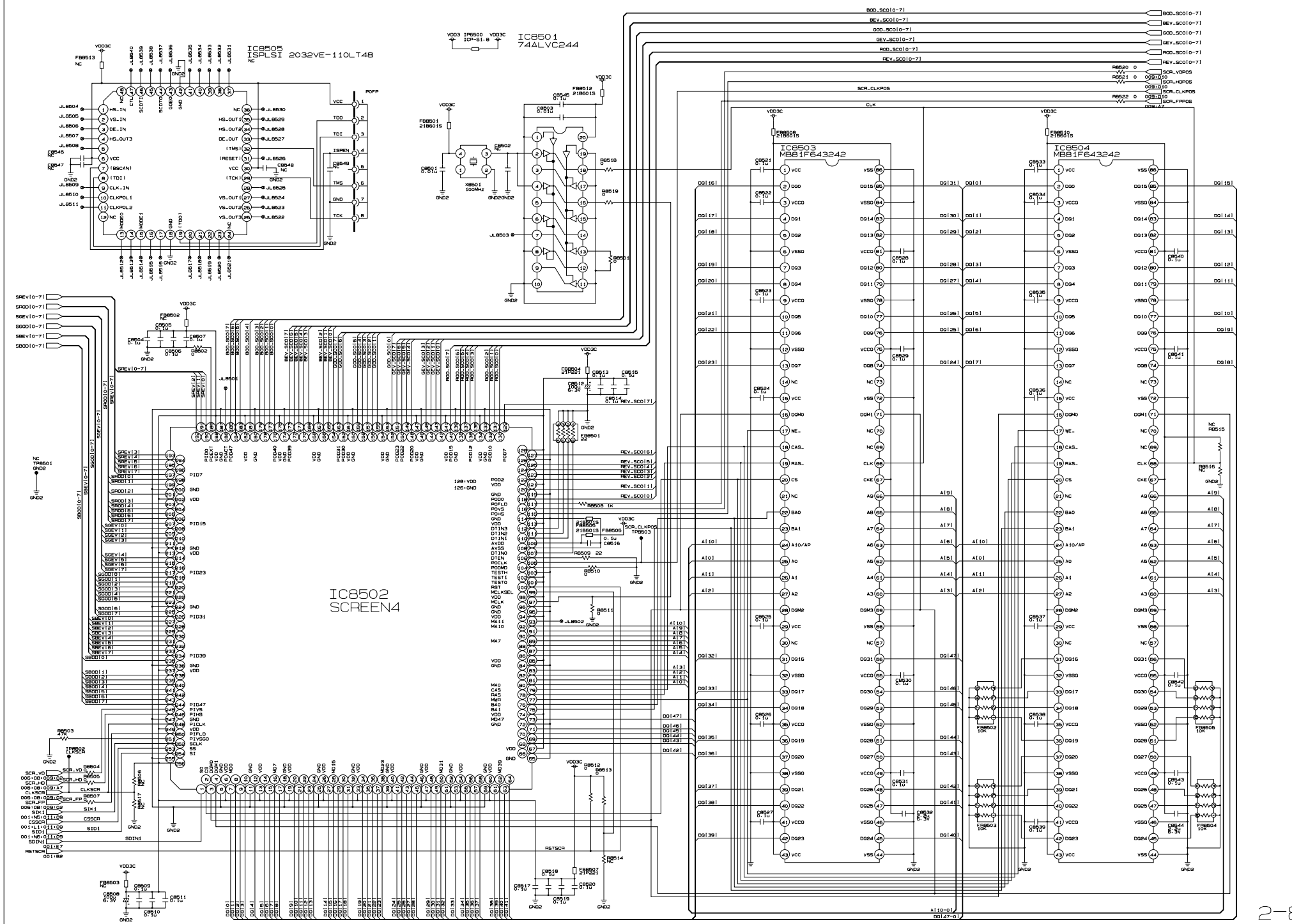
1
2
3
4
5
6
7
8
9
10
11



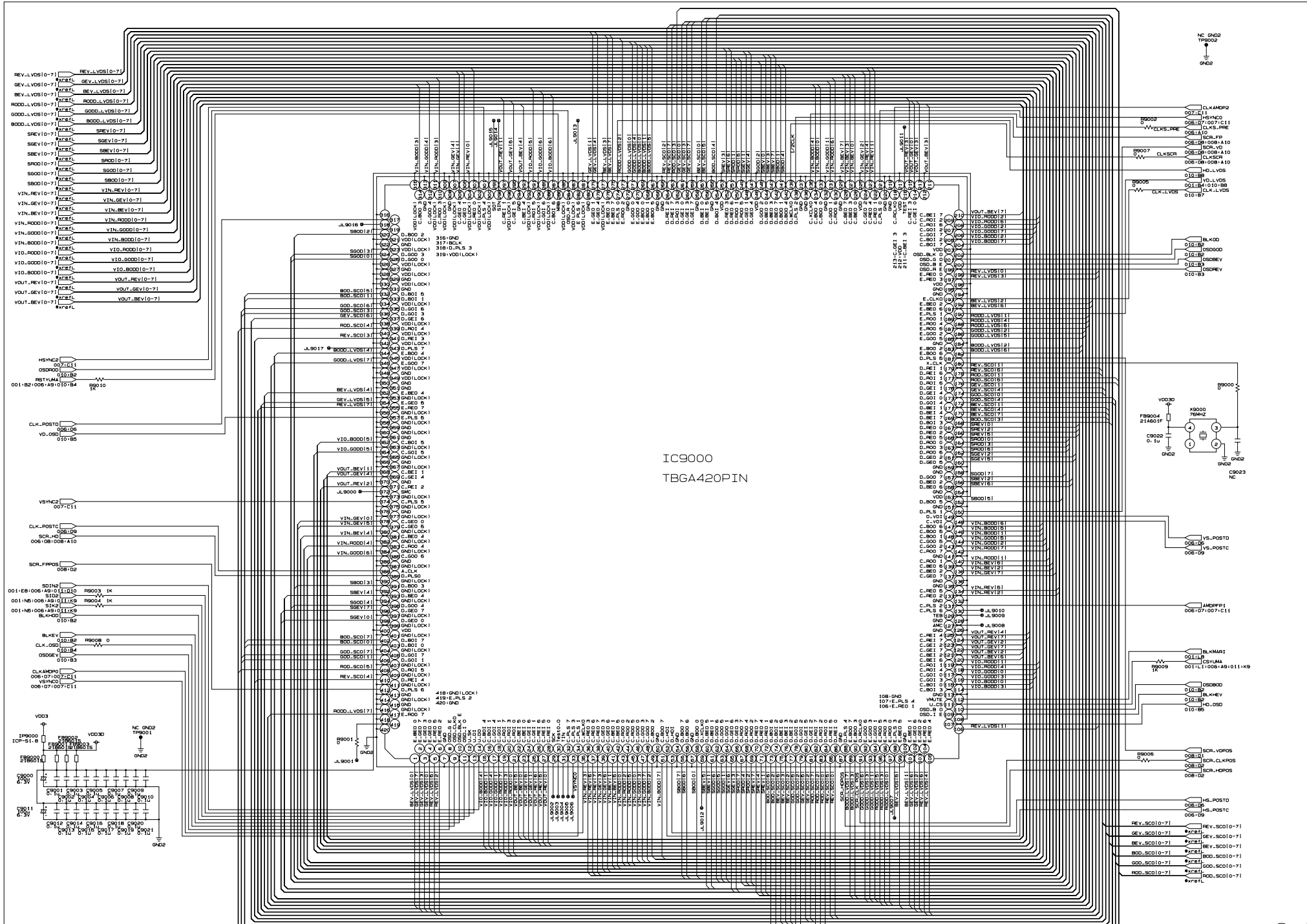
NEC MAIN PWB PCB-5002

1
2
3
4
5
6
7
8
9
10
11

A B C D E F G H I J K L M N O P



1
2
3
4
5
6
7
8
9
10
11



POWER FAN

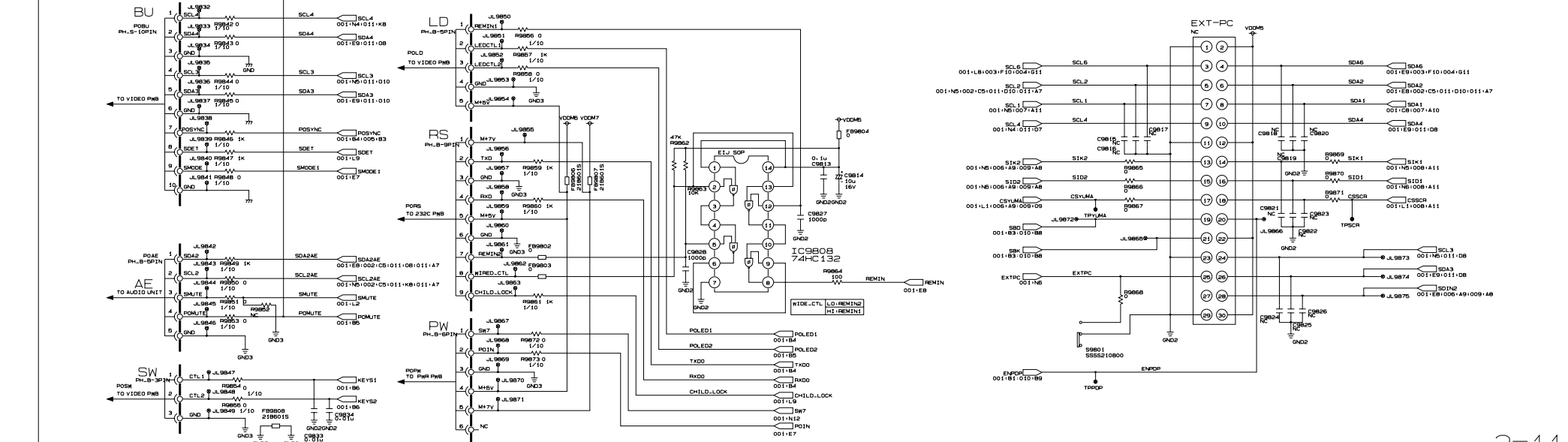
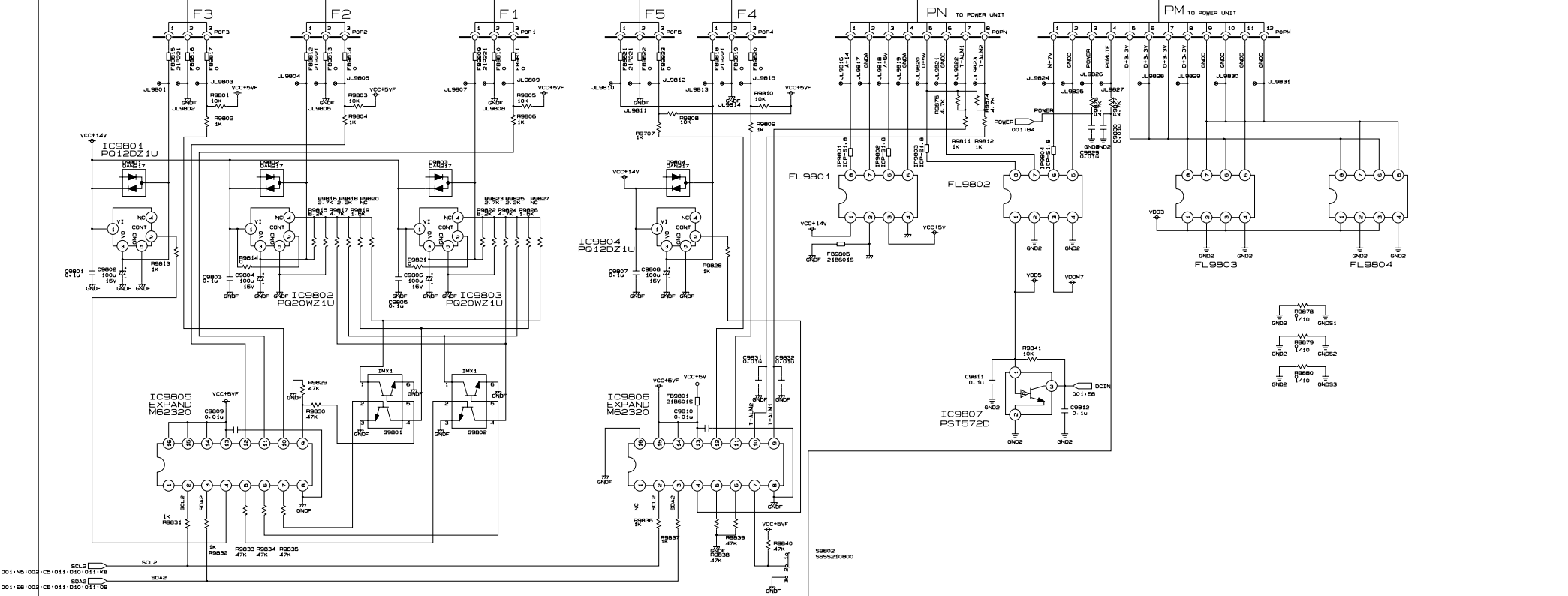
SET FAN

ASSIST FAN

PN TO POWER UNIT

PM TO POWER UNIT

1
2
3
4
5
6
7
8
9
10
11



NEC 232C PWB PWC-4419A

1

2

3

4

5

6

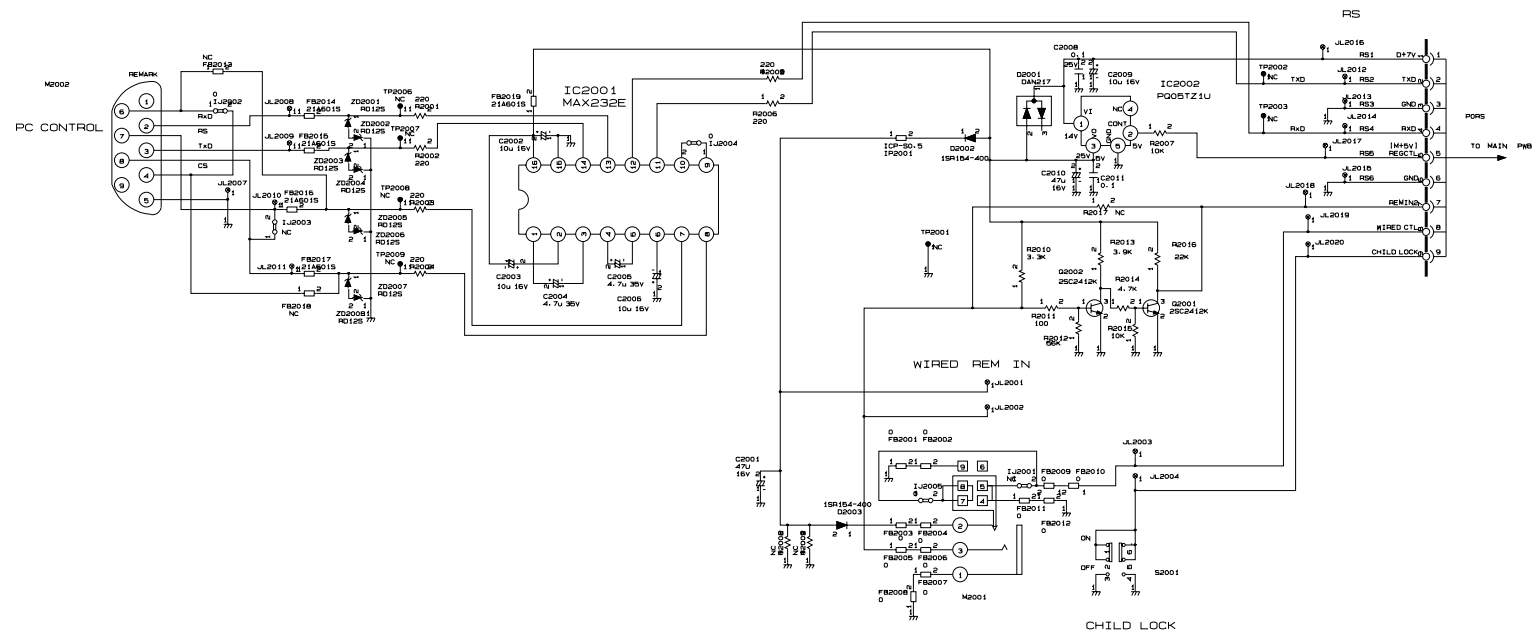
7

8

9

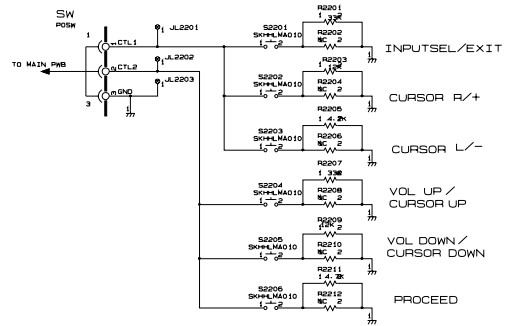
10

11

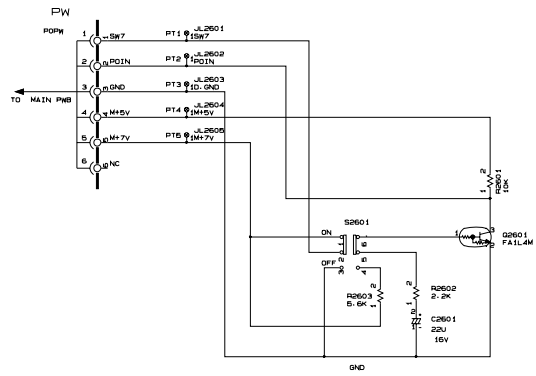


NEC CTL PWB PwC-4419B

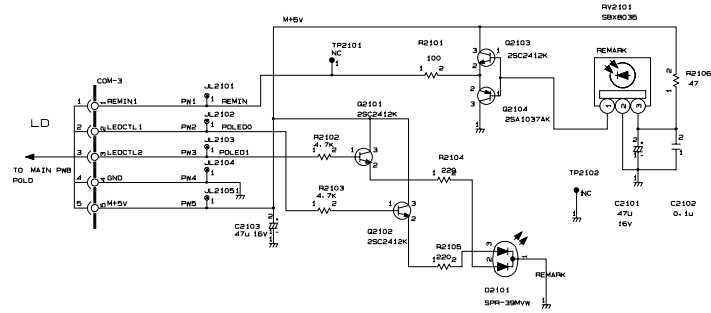
1
2
3
4
5
6
7
8
9
10
11



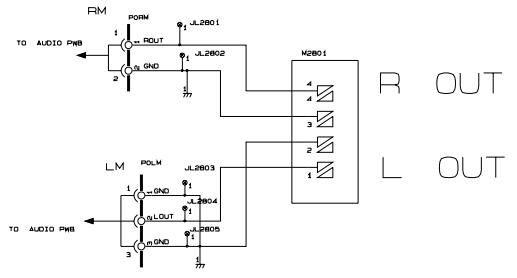
1
2
3
4
5
6
7
8
9
10
11



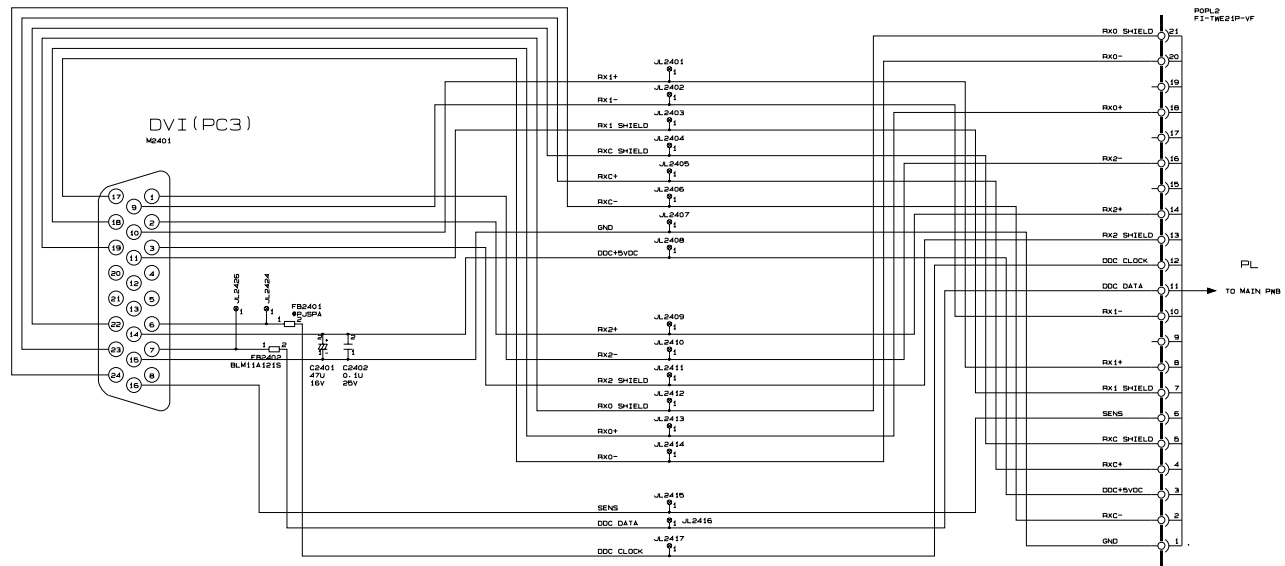
1
2
3
4
5
6
7
8
9
10
11



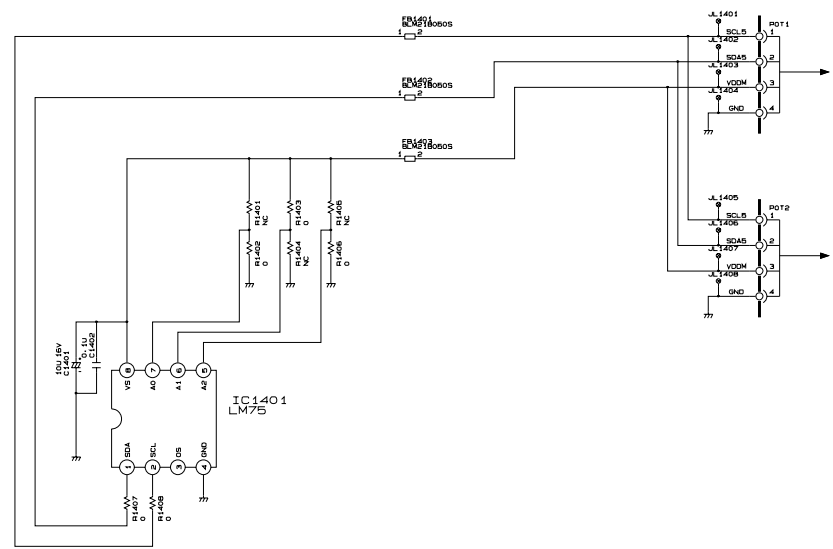
1
2
3
4
5
6
7
8
9
10
11



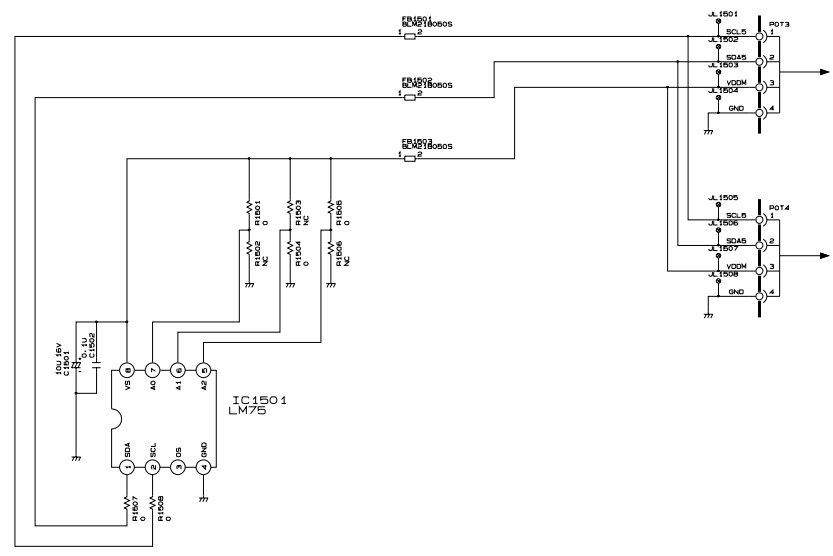
1
2
3
4
5
6
7
8
9
10
11



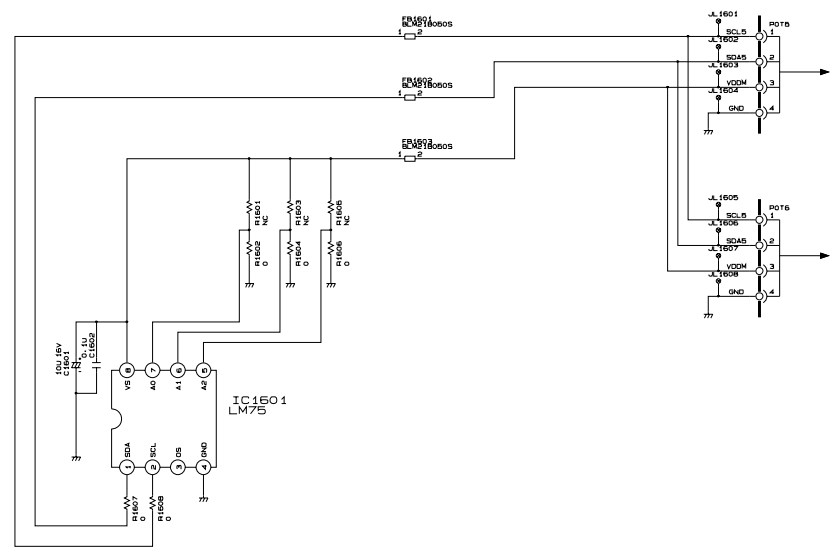
1
2
3
4
5
6
7
8
9
10
11



1
2
3
4
5
6
7
8
9
10
11



1
2
3
4
5
6
7
8
9
10
11



NEC